

# SOLUS Ultra™

## User Manual



---

# Legal Information

## Trademarks

Snap-on is a trademark, registered in the United States and other countries, of Snap-on Incorporated. This publication contains many Snap-on Incorporated trademarks, including but not limited to Snap-on, and ShopStream. All other marks are trademarks or registered trademarks of their respective holders.

## Copyright Information

© 2018 Snap-on Incorporated. All rights reserved.

## Disclaimer of Warranties and Limitation of Liabilities

All pictures and illustrations shown are for reference purposes only. All information, specifications and illustrations in this manual are based on the latest information available at the time of printing and are subject to change without notice. While the authors have taken due care in the preparation of this manual, nothing contained herein:

- Modifies or alters in any way the standard terms and conditions of the purchase, lease, or rental agreement under the terms of which the equipment to which this manual relates was acquired.
- Increases in any way the liability to the customer or to third parties.

Snap-on<sup>®</sup> reserves the right to make changes at any time without notice.

---

### IMPORTANT:

Before operating or maintaining this unit, please read this manual carefully paying extra attention to the safety warnings and precautions.

---

## Software License Information

Use of Software is governed by the terms and conditions of the End User License Agreement. The diagnostic tool should not be initially operated until the End User License Agreement is read. Use of the device acknowledges your acceptance of the End User License Agreement. The Snap-on Incorporated Software End User License Agreement may be provided with the diagnostic tool, and is available at: <https://eula.snapon.com/diagnostics>.

## Patent Information

For a listing of Snap-on products that are protected by patents in the United States and elsewhere, visit: <https://patents.snapon.com>

## User Manual Information

This manual includes information and images applicable with diagnostic software version 18.4 and later. Some information within this manual may not be applicable with other diagnostic software versions.

The information in this manual is periodically revised to ensure the latest information is included. The current version of this manual and other technical documentation is available online from Snap-on Diagnostics.

# Product Support Information

## Phone / E-mail - Technical Assistance

+44 (0) 845 601 4736 / [diagnosticsUKproductsupport@snapon.com](mailto:diagnosticsUKproductsupport@snapon.com)

## Website Links:

### Snap-on Diagnostics and Information

- <http://diagnostics.snapon.co.uk>

**Manuals / Technical Documentation** - This manual is periodically revised to ensure the latest information is included. Download the latest version of this manual and other related technical documentation at:

- <https://www.snapon.com/diagnostics/uk/User-Manuals.htm>

For technical assistance in all other markets, contact your selling agent.

## Product Training Videos

Diagnostic tool specific training videos are available on our website. Follow along and learn the basics of diagnostic tool operation with our free training videos.

Videos are product specific and are available at:

<http://diagnostics.snapon.co.uk> - Click on the "Training and Support" tab, select "Diagnostic Tools", then select the applicable diagnostic tool, and then select "See Quick Tips".



### NOTE:

Sample titles are listed below. Not all titles may be available for all diagnostic tools, and are subject to change.

Snap-on® Training Solutions® - Training Videos (examples)	
Introduction and Navigation	Global OBD-II
Scanner Codes	Digital Multimeter
Scanner Data in PID View	Graphing Multimeter & Lab Scope
Scanner Data in Graphing View	Guided Component Tests
Fast-Track® Troubleshooter	Vehicle Specs & Resets
Functional Tests	SureTrack® & Wi-Fi

## Diagnostic Quick Tips - Video Series

Snap-on Diagnostic Quick Tips videos are available at no charge on our website and on our YouTube channel. These videos are developed from real repair case studies to help professional technicians use diagnostic tools to solve specific vehicle problems (e.g. performing a Ford Relative Injector Flow Test).

Additional videos are also available showing specific diagnostic tool features (e.g. ShopStream Connect - Software Updates).



Figure 1-1

Videos are available at:

<http://diagnostics.snapon.co.uk> - Click on "Diagnostic Tools", then select the applicable diagnostic tool, then select "See Quick Tips"

<https://www.youtube.com/user/snaponscanner/videos> - Use the search function to find a title, or enter "Diagnostic Quick Tips" in the search field to see a list of all applicable titles.



**NOTE:**

URL links (above) and titles listed (below) are subject to change and may not be available in all markets.

A sample list of titles are listed below, other titles may be available.

Some videos may not be applicable for use with all diagnostic tools.

Snap-on® Training Solutions® - Diagnostic Quick Tips Videos (examples)	
Air/Fuel Ratio Sensor Test	Fuel Injector Voltage and Current Tests (Scope)
Alternator Ripple Test (Scope)	Fuel Pump Current Ramp Test (Scope)
BMW® Rain Sensor Calibration	Harley-Davidson® ABS Brake Bleed
CAN Bus Diagnostics (Scope)	Harley-Davidson® Functional Tests
Chevrolet® Volt Coolant Pump Bleed	Harley-Davidson® Key Fob Programming

<b>Snap-on® Training Solutions® - Diagnostic Quick Tips Videos (examples)</b>	
Chrysler HVAC Test	Hyundai Blind Spot Detection System Calibration
Chrysler VVT System Cleaning	Hyundai Occupant Detection System Reset
Chrysler Wheel & Tire Calibrations	Ignition Coil Current and Voltage Comparison
COP Ignition Test	Ignition Coil Current Ramp Test
Dual Screen Diagnostics: Scanner vs. Scope	Ignition Coil Primary Voltage Test
Electronic Throttle Control System Diagnostics	Ignition System Diagnostics Using the SIA2000 (Scope)
FIAT® 500 Proxi Alignment	MINI Battery Relearn
FIAT® 500 Throttle Body Relearn	Multi Channel Cam / Crank Correlation
Flex Ray Bus Diagnostics	OBD-II Mode 10 Permanent Codes
Ford Battery Monitor System	Oil Specs & Service Light Resets
Ford Coil Current RFI Test (Scope)	PID Trigger Functions (Scanner)
Ford Flash Reprogramming	Piezo Injectors Signature Test
Ford Misfire Monitor Neutral Profile Correction (Scanner)	Relative Compression Test (Scope)
Ford PATS Key Programming	ShopStream Connect - Data Manipulation
Ford Relative Compression Test	ShopStream Connect - Software Updates
Ford Relative Injector Flow Test	Speed Up Your Diagnostics (Scanner)
Ford TPMS Reprogramming	The Power of Troubleshooter Tips (Scanner)
Ford® 6.7L Transmission Solenoid Characterization	Top Level Menus: Built In Scope Training
Ford® Diesel Injector Coding	Toyota EVAP Test
VW / Audi Flexible Service Reset (Scanner)	Toyota Multiple Freeze Frame (Scanner)
	Toyota Transmission Compensation Coding

# Contents

<b>Chapter 1: Using This Manual .....</b>	<b>5</b>
Conventions.....	5
Bold Text.....	5
Symbols .....	5
Terminology .....	6
Notes and Important Messages .....	6
Procedures.....	6
<b>Chapter 2: Introduction.....</b>	<b>7</b>
Functional Description .....	7
Technical Specifications .....	9
Control Keys .....	10
Accept (Y/✓) Key .....	10
Directional Keys .....	10
Cancel (N/X) Key .....	11
S (Shortcut) Key.....	11
Power Key.....	11
Power Sources .....	11
Internal Battery Pack.....	11
AC Power Supply.....	12
Vehicle Power .....	12
The Stand .....	12
<b>Chapter 3: Getting Started.....</b>	<b>13</b>
Powering Up .....	13
Home Screen.....	13
Home Screen Buttons.....	14
The Demonstration Program.....	15
Powering Down .....	15
Emergency Shutdown.....	15
<b>Chapter 4: Navigation .....</b>	<b>16</b>
Screen Layout .....	16
Title Bar.....	16
Toolbar .....	17
Main Body .....	18
Screen Messages.....	19
Loading and Connecting Messages.....	19
Confirmation Messages .....	19
Warning Messages .....	19
Error Messages.....	19
<b>Chapter 5: Scanner.....</b>	<b>20</b>
Vehicle Identification.....	20
Alternative Vehicle Identification .....	22

Connecting to a Vehicle.....	22
Cables .....	23
No Communication Message .....	23
Operations .....	24
Codes Menu.....	25
Data Display.....	30
Functional Tests.....	38
Troubleshooter .....	38
Exiting the Scanner .....	39
<b>Chapter 6: OBD-II/EOBD .....</b>	<b>40</b>
OBD Health Check .....	40
Global OBD II Code Check .....	41
Global OBD II Clear Codes .....	42
Readiness Monitors .....	42
Connector Information .....	42
OBD Diagnose.....	43
Start Communication .....	43
Select Communication Protocol.....	48
Connector Information .....	48
<b>Chapter 7: Previous Vehicles and Data .....</b>	<b>49</b>
Vehicle History.....	49
View Saved Data .....	50
Viewing Codes and Code Scan Results .....	51
Delete Saved Data .....	52
<b>Chapter 8: Tools .....</b>	<b>53</b>
Tools Menu.....	53
Connect to PC.....	53
Configure Shortcut Key .....	54
System Information .....	55
Settings .....	55
<b>Chapter 9: Maintenance .....</b>	<b>63</b>
Cleaning and Inspecting the Scan Tool.....	63
Cleaning the Touch Screen .....	63
Battery Service .....	63
Battery Safety Guidelines .....	64
Replacing the Battery Pack.....	64
Disposing of the Batteries .....	65
<b>Chapter 10: ShopStream Connect .....</b>	<b>66</b>
Using SSC (Connecting to your PC) .....	66
SSC Main Screen .....	67
Scanner DataViewer.....	68
Image Viewer.....	69
Printing the Code Scan Report.....	70
Software Upgrades and Updates .....	71
End User License Agreement .....	73

# Safety Information

For your own safety and the safety of others, and to prevent damage to the equipment and vehicles upon which it is used, it is important that the accompanying *Important Safety Instructions* be read and understood by all persons operating, or coming into contact with, the equipment. We suggest you store a copy near the unit in sight of the operator.

This product is intended for use by properly trained and skilled professional automotive technicians. The safety messages presented throughout this manual are reminders to the operator to exercise extreme care when using this test instrument.

There are many variations in procedures, techniques, tools, and parts for servicing vehicles, as well as in the skill of the individual doing the work. Because of the vast number of test applications and variations in the products that can be tested with this instrument, we cannot possibly anticipate or provide advice or safety messages to cover every situation. It is the automotive technician's responsibility to be knowledgeable of the system being tested. It is essential to use proper service methods and test procedures. It is important to perform tests in an appropriate and acceptable manner that does not endanger your safety, the safety of others in the work area, the equipment being used, or the vehicle being tested.

It is assumed that the operator has a thorough understanding of vehicle systems before using this product. Understanding of these system principles and operating theories is necessary for competent, safe and accurate use of this instrument.

Before using the equipment, always refer to and follow the safety messages and applicable test procedures provided by the manufacturer of the vehicle or equipment being tested. Use the equipment only as described in this manual.

Read, understand and follow all safety messages and instructions in this manual, the accompanying safety manual, and on the test equipment.

## Safety Message Conventions

Safety messages are provided to help prevent personal injury and equipment damage. All safety messages are introduced by a signal word indicating the hazard level.

### **DANGER**

Indicates an imminently hazardous situation which, if not avoided, will result in death or serious injury to the operator or to bystanders.

### **WARNING**

Indicates a potentially hazardous situation which, if not avoided, could result in death or serious injury to the operator or to bystanders.

### **CAUTION**

Indicates a potentially hazardous situation which, if not avoided, may result in moderate or minor injury to the operator or to bystanders.



Safety messages contain three different type styles.

- Normal type states the hazard.
- **Bold type states how to avoid the hazard.**
- *Italic type states the possible consequences of not avoiding the hazard.*

An icon, when present, gives a graphical description of the potential hazard.

Example:



Risk of unexpected vehicle movement.

- **Block drive wheels before performing a test with engine running.**  
*A moving vehicle can cause injury.*

## Important Safety Instructions

For a complete list of safety messages, refer to the accompanying safety manual.

# SAVE THESE INSTRUCTIONS

This manual contains tool usage instructions. Some of the illustrations shown in this manual may contain modules and optional equipment that are not included on your system. Contact your sales representative for availability of other modules and optional equipment.

## 1.1 Conventions

The following conventions are used.

### 1.1.1 Bold Text

Bold emphasis is used in procedures to highlight selectable items such as buttons and menu options.

Example:

- Press the **OK** button.

### 1.1.2 Symbols

Different types of arrows are used.

The “greater than” arrow (>) indicates an abbreviated set of selection instructions.

Example:

- Select **Tools > Connect-to-PC**.

The example statement abbreviates the following procedure:

1. Select **Tools** from the home screen.
2. Highlight **Connect-to-PC** on the Tools menu.
3. Select **Connect-to-PC**.

The solid arrows (◀, ▶, ▼, ▲) are navigational instructions referring to the four directions of the directional arrow keys.

Example:

- Press the down ▼ arrow.

### 1.1.3 Terminology

The term “select” means highlighting a button or menu item and pressing the **Accept**, **OK**, **Yes**, or other similar button to confirm the selection.

Example:

- Select **Brightness**.

The above statement abbreviates the following procedure:

1. Navigate to and highlight the **Brightness** selection.
2. Press the **OK**, or similar, button.

### 1.1.4 Notes and Important Messages

The following messages are used.

#### Notes

A NOTE provides helpful information such as additional explanations, tips, and comments.

Example:



#### NOTE:

For additional information refer to...

---

#### Important

IMPORTANT indicates a situation which, if not avoided, may result in damage to the test equipment or vehicle.

Example:

---

#### IMPORTANT:

Do not disconnect the data cable while the Scanner is communicating with the ECM.

---

### 1.1.5 Procedures

An arrow icon indicates a procedure.

Example:



#### To change screen views:

1. Select the **Graph** icon.  
The dropdown menu displays.
2. Select an option from the menu.  
The screen layout changes to the format selected.

The Scanner interfaces with the electronic control system of a vehicle to retrieve diagnostic trouble codes (DTCs), access serial data stream information, and command bi-directional tests. Various vehicle control systems, such as engine, transmission, and antilock brake system (ABS), are readily diagnosed using this scan tool. The Scanner is capable of graphing up to four live data parameters on a single screen, and also includes an extensive database of vehicle-specific troubleshooting information.

This chapter describes the construction of the scan tool and addresses the use of the basic hardware controls and features in the following sections:

- “Functional Description” on page 7
- “Technical Specifications” on page 9
- “Control Keys” on page 10
- “Power Sources” on page 11
- “The Stand” on page 12

## 2.1 Functional Description



- 1— N/X Key (No, Cancel, or Return)
- 2— Y/✓ Key (Yes, Accept, or Continue)
- 3— Directional Keys; left (◀), right (▶), up (▼), down (▲)
- 4— Shortcut Key
- 5— Power Key

Figure 2-1 Front view

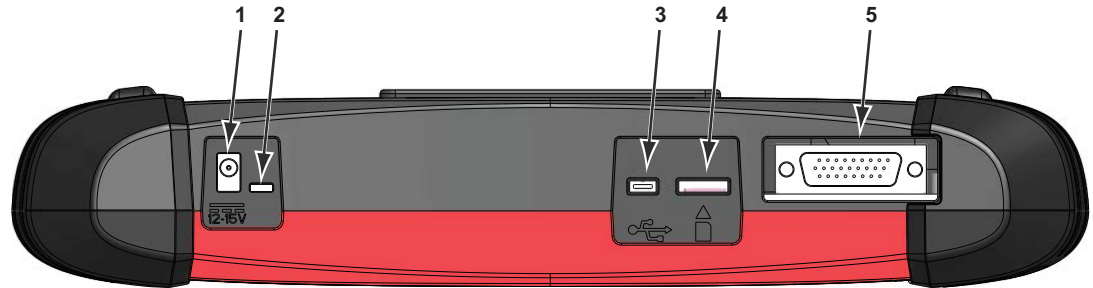

- 1— DC Power Supply Input Port
- 2— Battery Status Indicator LED (light emitting diode)
- 3— Mini USB Client Port
- 4— Micro secure digital (uSD) Card Port
- 5— Data Cable Port

Figure 2-2 Top view

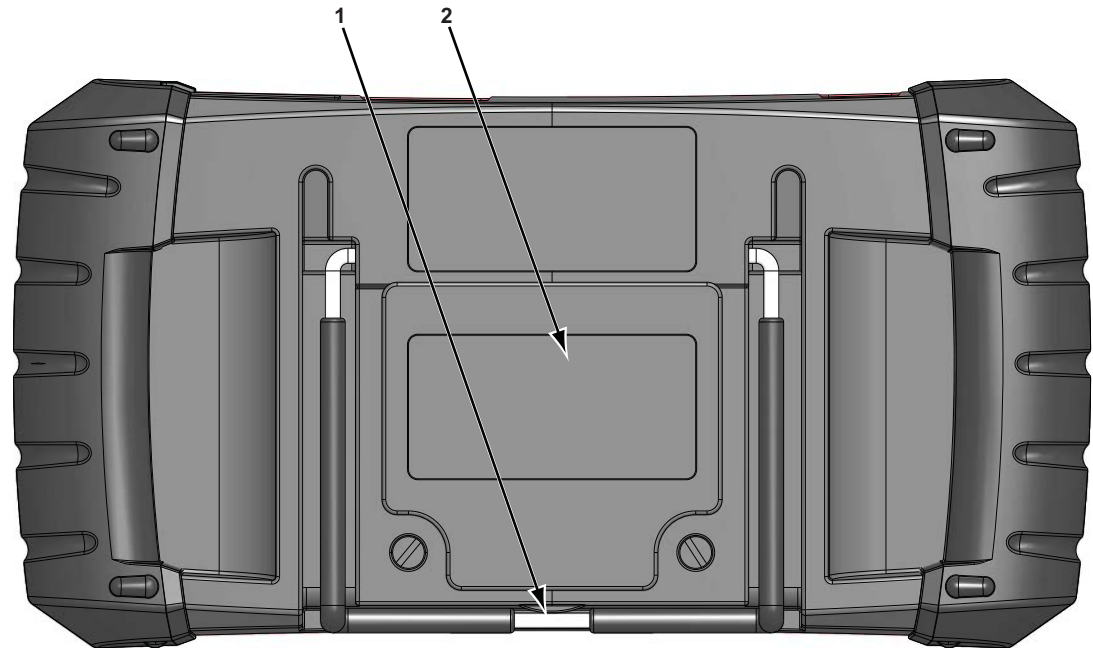

- 1— Collapsible Stand (closed)
- 2— Battery Compartment Cover

Figure 2-3 Back view

## 2.2 Technical Specifications

### Touch Screen

Resistive Touch Panel

### Display:

7.0 inch diagonal, Color LCD  
800 x 480 resolution SWVGA

### Battery:

Rechargeable lithium-ion battery pack  
Approximately 2 hour run time  
Approximately 5 hour charge time

### DC Jack Operating Voltage

10V and 28V DC

### Dimensions:

Width:

11.2 inches  
285.0 mm

Height:

5.98 inches  
151.8 mm

Depth:

2.0 inches  
50.9 mm

### Weight (including battery pack):

2.6 lbs.  
1.18 kg

### Operating Temperature Range (ambient):

At 0 to 90% relative humidity (non-condensing)  
32 to 113°F  
0 to 45°C

### Storage Temperature (ambient):

At 0 to 70% relative humidity (non-condensing)  
-4 to 140°F  
-20 to 60°C

### Environmental Conditions:





This product is intended for indoor use only  
This product is rated for Pollution Degree 2 (normal conditions)

### Power Supply:

Supply Rating; 15 VDC, 2A

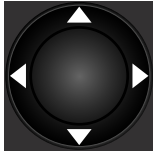
## 2.3 Control Keys

There are five control keys located on the right side of the unit near the handgrip:

Key	Icon	Description
Accept, Yes		Selects a menu or program, advances to the next screen, or provides a yes answer to a question on the screen.
Directional, Arrows		Moves the highlight on the display screen up, down, left, and right, as indicated by the arrows.
Cancel, No		Exits a menu or program, returns to the previous screen, or provides a no answer to a question on the screen.
Shortcut		A function key that can be programmed to provide a shortcut for performing a variety of routine tasks.
Power, On/Off		Turns the unit on and off. Also, press and hold for 5 seconds for emergency shutdown.

All other tool operations are controlled through the touch screen.

### 2.3.1 Accept (Y/✓) Key

The Y/✓ key is used to do the following:

- To select an item that was highlighted using the directional keys.
- To advance to the next screen in a series.
- To answer “Yes” when a Yes or No choice is given.

### 2.3.2 Directional Keys

The directional, or arrow, keys move the cursor or highlight in their respective directions:

- Up (▲)
- Down (▼)
- Left (◀)
- Right (▶)

### 2.3.3 Cancel (N/X) Key

The **N/X** key is used to do the following:

- To exit a menu or program.
- To close an open list and return to the previous menu.
- To answer “No” when a Yes or No choice is given.

### 2.3.4 S (Shortcut) Key

Use the **Shortcut** key to quickly capture an image of the current screen with a single key stroke. See ["Configure Shortcut Key," on page 54](#) for additional information.

### 2.3.5 Power Key

The **Power** key powers up the tool, and turns it off.

## 2.4 Power Sources

Your Display Device can receive power from any of the following sources:

- ["Internal Battery Pack"](#)
- ["AC Power Supply"](#)
- ["Vehicle Power"](#)

### 2.4.1 Internal Battery Pack

The scan tool can be powered from the internal rechargeable battery pack. A fully charged standard battery pack provides sufficient power for about 2 hours of continuous operation.

A multi-color LED on top of the unit ([Figure 2-2](#)) illuminates to indicate battery status. Interpret the LED as follows:

- Green indicates the battery is fully charged
- Red indicates the battery is being charged
- Amber indicates a battery or battery charging issue.

An amber LED is usually caused by excessive battery temperature (above 104°F/40°C), which disables charging. Allow the unit to cool down and make sure the ventilation ports are not obstructed if the LED is amber.



## 2.4.2 AC Power Supply

The scan tool can be powered from a standard wall socket using the AC power supply and power adapter. The jack on the output cable of the AC power supply attaches to the DC power supply input port on top of the scan tool. Use only the AC power supply provided.

## 2.4.3 Vehicle Power

The scan tool receives power from the test vehicle when it is connected to a powered data link connector (DLC) with the data cable. All OBD-II/EOBD compliant vehicles are required to have battery power available on the DLC. If the scan tool does not power on when connected to an OBD-II/EOBD DLC, there may be a circuit problem on the vehicle. Check the green LED on the data cable (see ["Cables," on page 23](#) for additional information). If the LED is not illuminated, suspect a problem on the DLC power circuit.

Certain vehicles do not provide vehicle power on the DLC. For these applications, a separate cable adapter and power cable are needed to power the unit. Optional data cable adapters are available for a number of vehicle manufacturers. Contact your sales representative for availability. The power cable connects to a port on the cable adapter.

---

**IMPORTANT:**

Never connect the optional power cable or the AC power supply to the DC power supply input on top of the unit when the scan tool is communicating with a vehicle.

---

## 2.5 The Stand

The built-in stand extends from the back of the unit to allow hands-free viewing. The stand clips into the unit for storage and pivots out so the display is at a 35 degree angle when in use.

Make sure the scan tool has a charged battery pack, is connected to a powered vehicle data link connector (DLC), or is connected to an AC power supply.

## 3.1 Powering Up

Press the **Power** key on the front of the unit to switch the scan tool on. The system boots up, then opens the Home screen (Figure 3-1).

## 3.2 Home Screen

The main body of the Home screen has four selectable buttons, one for each of the primary scan tool functions. These are explained briefly in the next section and discussed in detail in the Navigation chapter.

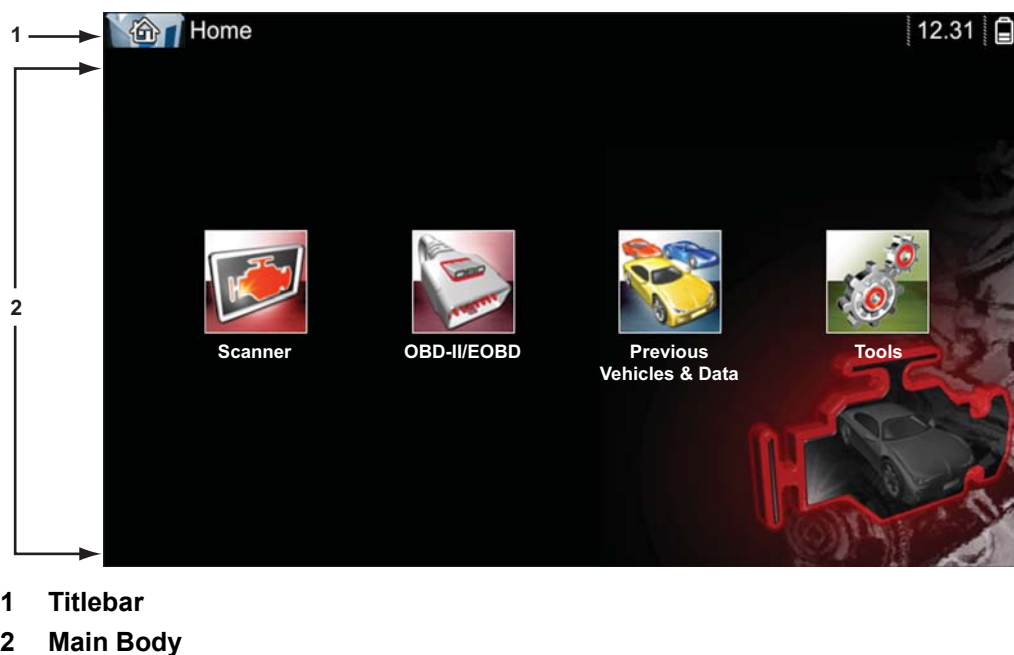







Figure 3-1 Sample Home screen

The titlebar, which runs across the top of the screen, provides information about the current screen or a description of the defined test vehicle. The title bar contains no selectable items. A graphic indicator at the right edge of the toolbar shows the status of the tool power supply:





**Table 3-1** Power supply icons

Icon	Definition
	Indicates power is being supplied by the internal battery pack
	Indicates the internal battery pack is weak and needs recharging
	Indicates power is being supplied by the AC power supply
	Indicates power is being supplied by the vehicle
	Indicates the scan tool is actively communicating with a vehicle

### 3.2.1 Home Screen Buttons

The Home screen buttons allow you to select which of the primary scan tool functions to use. The table below gives brief descriptions of the button operations.

**Table 3-2** Home screen buttons

Name	Button	Description
Scanner		Open a list of vehicle manufacturers to begin the process of establishing a communications link to the test vehicle.
OBD-II/EOBD		Performs generic OBD-II/EOBD system tests without first identifying a test vehicle.
Previous Vehicle & Data		Use to connect to a recently tested vehicle, or to access saved data files.
Tools & Setup		Select to adjust tool settings to your personal preferences, to access scan tool system information, and perform other special operations.

Select from the Home screen buttons to begin testing.

## 3.2.2 The Demonstration Program

The Scanner demonstration program allows you to become familiar with many of the test capabilities of the tool without connecting to a vehicle. The demonstration contains actual data captured while driving a 2001 Chevrolet Tahoe.



### To start the demonstration program:

1. From the Home screen, tap the **Scanner** icon.  
The manufacturer menu, which lists all of the makes available for testing, displays.
2. Tap the **Demonstration** button included on the manufacturer menu.
3. A screen advising you are in simulation mode displays, select **Continue**.

---

### IMPORTANT:

Do not connect a vehicle to the scan tool while in the Demonstration mode.

- 
4. Follow the on-screen instructions and select as needed until the confirmation screen displays.
  5. Select **OK** on the confirmation screen to load the selected database.
  6. Select **OK** from the Demo mode message screen.  
A systems menu, which shows all of the systems available for testing, displays
  7. Select from any of the systems listed, then select from the submenus.



---

### NOTE:

There is also an OBD-II/EOBD demonstration, select "**OBD Training Mode**" in OBD-II/EOBD.

---

## 3.3 Powering Down

Use the **Power** key to turn the scan tool off.

---

### IMPORTANT:

All vehicle communication must be terminated before shutting down the scan tool. A warning message displays if you attempt to shut down while the Scanner is communicating with the vehicle. Forcing a shut down while communicating may lead to ECM problems on some vehicles. Exit vehicle communications before powering down.

---



### To power off the unit:

1. Press **N/X** or **Back** until you reach the Home screen.  
A "stopping communication" message appears briefly before the Home screen displays.
2. Disconnect the test adapter from the vehicle connector.
3. Press the **Power** key.  
The Turn off dialog box displays.
4. Press **Y/✓** to turn the power off, or press **N/X** to cancel and test a different vehicle.

### 3.3.1 Emergency Shutdown

In case of emergency, press and hold the Power key to force a shutdown.

This chapter describes the scan tool screen layout, and to make selections using screen menus and buttons, and the various types of messages that display while using the tool.

## 4.1 Screen Layout

Scan tool screens (Figure 4-1) typically include the following sections:



- 1— **Title bar**—shows test and tool status
- 2— **Toolbar**—contains test controls
- 3— **Main body**—displays menus and test data

Figure 4-1 Sample scan tool screen

### 4.1.1 Title Bar

The title bar at the top of the screen, provides basic information about current tool operating conditions. Title bar options vary depending upon vehicle make and model, what test is being performed or what menu is selected. Title bar information may include:

- The identification (ID) of the test vehicle
- The name of the active menu or database
- A power source indicator
- A vehicle communication indicator

Depending upon what is being displayed in the main body of the screen, either the vehicle ID or the active menu is shown at the left side of the title bar.













An icon at the far right side of the title bar indicates whether the tool is being powered by the internal battery pack, the test vehicle, or the AC power supply.

A communication icon displays to the left of the power source indicator whenever the scan tool is actively communicating with a test vehicle or a personal computer.





### 4.1.2 Toolbar

The toolbar, located under the title bar, contains a number of selectable buttons that control tool functions. What buttons appear on the toolbar varies, as only buttons that are active or available for the current screen and test mode display. A brief description of common toolbar button operations are shown in [Table 4-1](#). Additional buttons appear on the toolbar when special operations are available. These buttons are explained in the Operations chapter.

**Table 4-1** Data toolbar buttons (part 1 of 2)

Button	Icon	Function
Back		Returns to the previously viewed screen. This button is always at the left-hand edge of the toolbar.
Home		Returns to the Home screen. This button is always alongside the Back button on the left side of the toolbar.
Pause		Indicates live data from the vehicle is being displayed.
Record		Indicates the data being displayed is paused when reviewing a movie.
Clear		Erases all the data in the buffer and begins a new recording. Selecting opens a confirmation message.
Sort		Determines the order in which the data parameters are listed on the screen.
PID Triggering		Opens a menu that allows you to set, arm, and clear threshold values to automatically begin recording data.
Zoom		Increases and decreases the scale of the data graphs.
Custom Data List		Allows you to select which parameters to display from the list. This button displays when viewing a data list.
Graph		Switches between PID list and graph display modes. This button displays when viewing a data list.
Lock/Unlock		Locks or unlocks the highlighted parameter. This button displays when viewing a data list.
Save		Saves the current screen information, such as a Scanner movie, to tool memory.

**Table 4-1** Data toolbar buttons (part 2 of 2)

Button	Icon	Function
Tools		Opens the tools menu, which allows you to adjust basic tool settings.
Previous Frame		Moves back one frame at a time when viewing recorded or paused data. Hold the button down to keep moving back through the data.
Next Frame		Moves forward one frame at a time when viewing recorded or paused data. Hold the button down to keep moving forward through the data.
Back 10 Frames		Moves back 10 frames at a time when viewing recorded or paused data. Hold the button down to keep moving back through the data.
Forward 10 Frames		Moves forward 10 frames at a time when viewing recorded or paused data. Hold the button down to keep moving forward through the data.

When a selectable item on the screen is highlighted, a yellow frame surrounds the item to indicate that it is in focus.

### 4.1.3 Main Body

The main body of the screen is the lower portion, which displays either a menu of available tests or data from the vehicle. A vertical scroll bar appears on the main body of the screen when there is additional data either above or below what is currently shown on the display (Figure 4-2).



- 1— Go to beginning
- 2— Go up 1 page
- 3— Slider (position indicator)
- 4— Go down 1 page
- 5— Go to end

**Figure 4-2** Sample scroll bar

Tap the arrowheads at the ends of the scroll bars to move through the data in the direction of the arrow one page at a time. Selecting an arrowhead that points to a line moves you directly to the beginning or end of the data. The slider in the center portion of the scroll bar indicates the relative position of the current screen to the total available data.

## 4.2 Screen Messages

There are four types of on-screen messages:

- Loading and connecting
- Confirmations
- Warnings
- Errors

### 4.2.1 Loading and Connecting Messages

Loading and connecting messages display when the scan tool is performing an internal operation, such as loading a database, initiating a test, or establishing communications with the vehicle. The message automatically clears once the internal operation is complete.

### 4.2.2 Confirmation Messages

Confirmation messages inform you when you are about to perform an action that cannot be reversed or when an action that requires your confirmation to continue has been initiated.

When a response is not required, the message displays briefly, then disappears.

### 4.2.3 Warning Messages

Warning messages inform you when completing the selected action may result in an irreversible change or loss of data.

### 4.2.4 Error Messages

Error messages inform you when a system or procedural error has occurred.

Examples of possible errors include:

- A cable is disconnected.
- A peripheral, such as a printer is powered off.



The Scanner establishes a data link to the electronic control systems of the vehicle being serviced. This allows you to retrieve diagnostic trouble codes (DTCs) view live data parameters, and perform tests. Scanner testing requires connecting the scan tool to the test vehicle using the data cable and test adapters. On screen instructions tell you how to connect the Scanner. Additional connection information can be found in the appropriate vehicle communication software manual for the test vehicle.

## 5.1 Vehicle Identification

The Scanner information presented is provided by the ECM of the vehicle being tested. Therefore, certain attributes of the test vehicle must be entered into the scan tool to ensure the data displays correctly. This vehicle identification sequence is menu driven, simply follow the screen prompts and make a series of choices. Each selection advances you to the next screen. Exact procedures may vary somewhat by the make, model, and year of the test vehicle.



### To identify a vehicle for Scanner testing:

1. Tap the **Scanner** button from the Home screen.  
A list of manufactures displays ([Figure 5-1](#)).

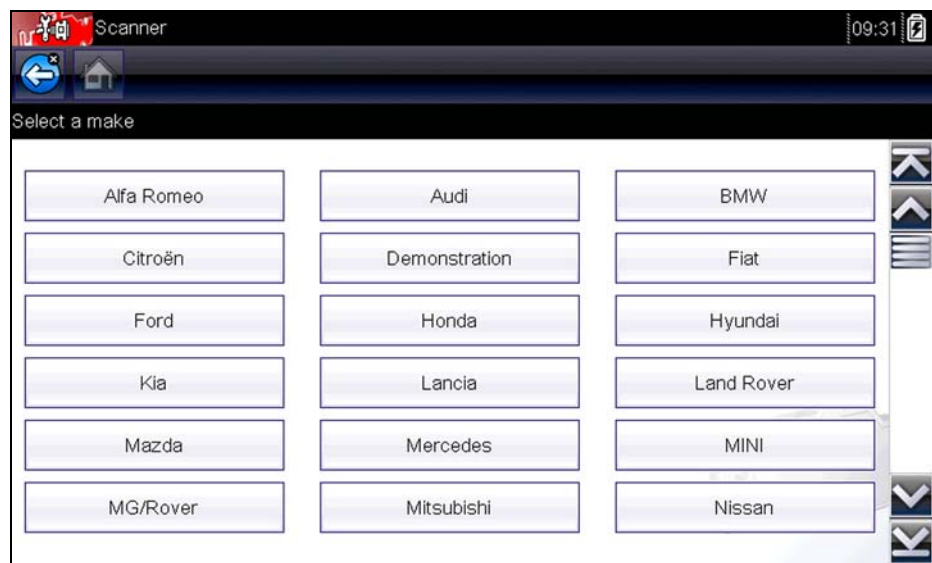

Figure 5-1 Sample manufacturer list

The list includes Demonstration, which opens the Demonstration program (see [“The Demonstration Program”](#) on page 15).

2. Select the manufacturer of the test vehicle from the list.  
A model year menu displays.

3. Select the year of the test vehicle from the menu.  
A list of vehicle types or models displays. Several selections may be required to identify the vehicle type and model, follow the screen prompts and enter the required information.  
A confirmation screen displays once all the required data has been entered (Figure 5-2).

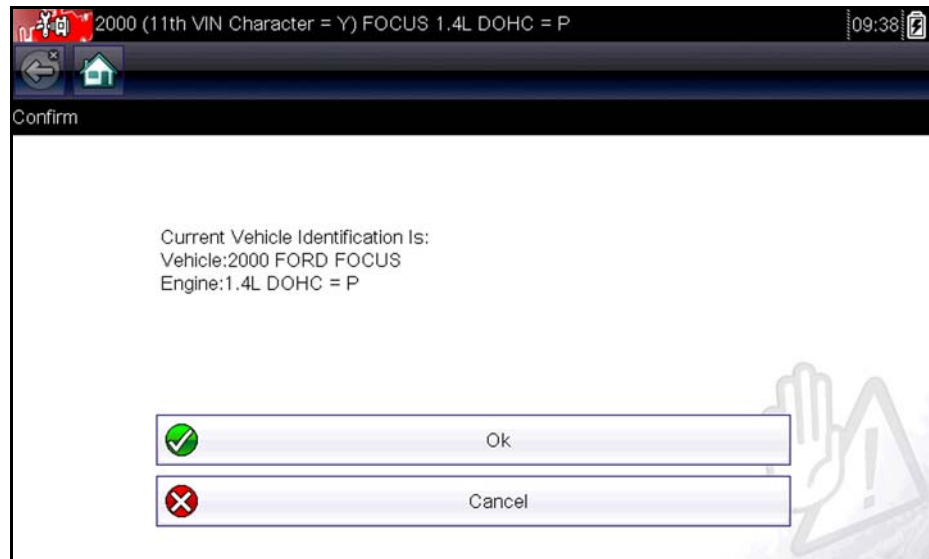

Figure 5-2 Sample confirmation dialog box

4. From the Confirm Vehicle screen select:
  - a. **OK** to continue.
  - b. **Cancel** to return to the engine list.When Yes is selected list of systems available for testing on the identified vehicle displays.
5. Select a system from the list to continue (Figure 5-3).



Figure 5-3 Sample available systems list

**NOTE:**

Only the systems available for testing on the identified vehicle are included in the list.

The identification sequence is now complete.

### 5.1.1 Alternative Vehicle Identification

Occasionally, you may identify a test vehicle that the Scanner does not recognize, the database does not support, or has some unique characteristics that prevent it from communicating with the Scanner through the normal channels. In these instances, a menu of alternate choices that allow you to establish communication with the vehicle by other means displays. In addition to being able to identify a different manufacturer, the following alternatives are available:

- OBDII/EOBD—allows you to perform generic OBD-II or EOBD tests, see [“OBD-II/EOBD” on page 40](#) for additional information.
- System ID Mode—allows you to begin the vehicle identification by first selecting the system to be tested. Selecting opens a menu of manufacturers that support this mode.
- Select by Database—allows you to begin the vehicle identification by first selecting which manufacturer database to load. Selecting opens a menu of available databases.

## 5.2 Connecting to a Vehicle

Make a selection from the systems available for testing list and instructions for connecting the Scanner to the vehicle with the data cable are shown on the screen ([Figure 5-4](#)).

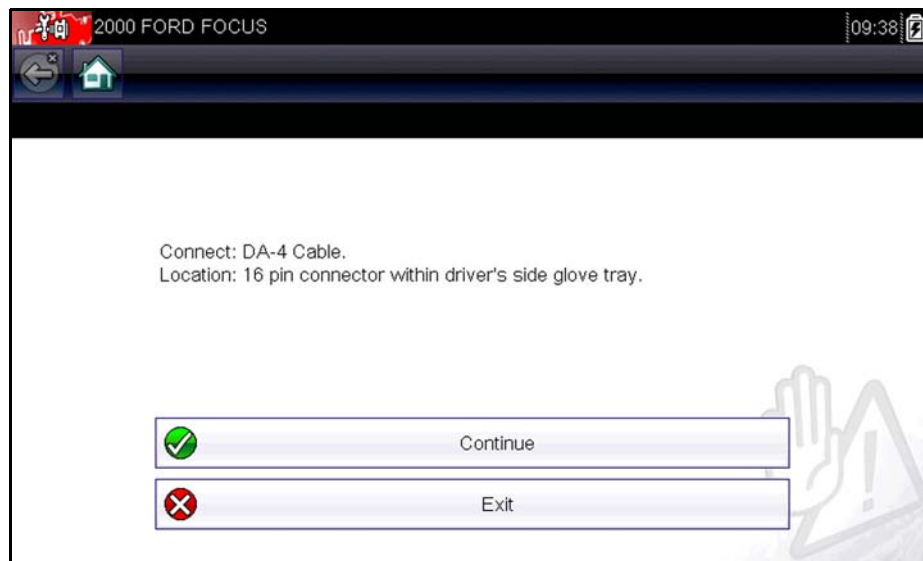

**Figure 5-4** Sample vehicle connection message

If an optional cable adapter is needed, the instructions tell you which one to use, and also where to locate the vehicle diagnostic connector to perform the selected tests. Refer to the appropriate *Vehicle Communication Software Manual* for additional details.

## 5.2.1 Cables

One of two data cables, one for OBD-II/EOBD compliant vehicles and an optional one for non-OBD-II/EOBD models, is used to connect the scan tool to the test vehicle. The 26-pin end of either cable attaches to the data cable port on the top of the scan tool. The connector is secured with captive screws. The 16-pin end of the OBD-II/EOBD cable directly plugs into the data link connector (DLC) of the test vehicle. With the non-OBD-II/EOBD cable, a cable adapter attaches to the 15-pin end of the cable and the adapter then plugs into the vehicle test connector.

On-screen instructions on the scan tool tell you which cable, and adapter if needed, to use once a test vehicle has been identified. The screen message also includes the location of the vehicle diagnostic connector that the cable attaches to for testing the selected system.

A replaceable 7.5 amp blade-type fuse is installed in the vehicle connector end of the cable to protect the unit from high circuit voltage and current. A green LED, also on the vehicle connector end of the cable, illuminates whenever there is power supplied to the cable. An LED that fails to illuminate indicates either a problem on the vehicle power circuit or a blown data cable fuse.

All OBD-II/EOBD vehicles have vehicle battery power (B+) available on the DLC. The optional auxiliary power cable supplies power for testing non-OBD-II/EOBD models that do not have B+ available on the diagnostic connector. The optional cable and adapters are required for testing non-OBD-II/EOBD models.



### To connect the data cable to the vehicle:

1. Follow the on-screen instructions for connecting to the vehicle ([Figure 5-4](#)).
2. Once connected, select **Continue**.

The Scanner establishes communication then displays a list of available tests. If the Scanner is unable to establish a communications link, a “no communications” message displays.

3. Select from the available tests to open a submenu of test options.

## 5.2.2 No Communication Message

When the screen displays a “no communication” message, it means the scan tool and the vehicle control module cannot communicate with each other for some reason.

The following conditions cause a “no communication” message to display:

- The Scanner is unable to establish a communication link with the vehicle.
- You selected a system for testing that the vehicle is not equipped with (such as ABS).
- There is a loose connection.
- There is a blown vehicle fuse.
- There is a wiring fault on the vehicle.
- There is a circuit fault in the data cable or adapter.
- Incorrect vehicle identification was entered.

Refer to the Vehicle Communication Software manuals for manufacturer-specific problems.

## 5.3 Operations

The Scanner allows you to establish a data link to the electronic control systems of the vehicle being serviced in order to view live data parameters and perform tests. You can use selected functional tests, get troubleshooting tips, and get vehicle-specific trouble codes for various vehicle control systems such as engine, transmission, antilock brake system (ABS) and more.

The Scanner has two main functions:

1. **Scanner**—provides access to vehicle systems to perform functions such as reading codes, viewing data, and conducting functional tests.
2. **Fast-Track Troubleshooter**—provides the diagnostic power of Fast-Track Troubleshooter, a database of experience based information developed by master technicians.

After a system is selected and the Scanner establishes communication with the vehicle, a Scanner Main menu, which lists available tests, displays.



Figure 5-5 Sample Scanner Main menu

Main menu options vary slightly by the year, make, and model of the test vehicle. The main menu may include:

- **Data Display**—displays data parameter information from the vehicle control module. Selecting may open a submenu of viewing options.
- **Codes Menu**—displays diagnostic trouble code (DTC) records from the vehicle control module. Selecting may open a submenu of viewing options.
- **Clear Codes**—erases DTC records and other data from the ECM. This selection is found on a Codes submenu for some models.
- **Functional Tests**—provides specific subsystem and component tests. The tests vary depending on the manufacturer and model.
- **Actuator Tests**—similar to functional tests, checks the operation of certain actuators, such as solenoid valves and relays.
- **Memory Resets**—allows you to reprogram adaptive values for certain components after making repairs. Selecting opens a submenu. These options are found on the Functional Tests Menu for some models.

- **System Tests**—provides specific subsystem testing. Performing these tests is similar to functional tests.
- **Generic Functions**—lets you access certain available Generic OBD II functions from a proprietary menu (1996 and newer vehicles only).
- **Troubleshooter**—provides step-by-step procedures, integrating parameter data and retrieving trouble codes when appropriate, for specific symptoms of the identified vehicle.



#### To perform a Scanner test

1. **Launch the Scanner**—Tap **Scanner** on the Home screen.
2. **Identify the vehicle**—Identify the test vehicle by selecting from the menu options.
3. **Select the system**—Select the system to be tested from the systems menu.
4. **Connect the data cable to the vehicle**—Follow the on-screen connection instructions to connect the scan tool unit to the test vehicle.
5. **Select the test from the Scanner main menu**—Select the desired test.

### 5.3.1 Codes Menu

This selection may appear as Codes, Codes Menu, Codes Only, Codes (No Data), Service Codes or something similar on the menu. Selecting opens a list of data parameter viewing options that includes:

- Display Codes
- Clear Codes
- Freeze Frame/Failure Records
- DTC Status

#### Display Codes

Selecting either opens a list of diagnostic trouble codes (DTCs) stored in the selected electronic control module (ECM), or a submenu of DTC viewing options. Submenu options include:

- **Trouble Code Information**—opens a list of codes in ECM memory
- **History Codes**—opens a list codes whose symptoms are not currently present. History codes indicate an intermittently occurring problem.
- **Failed This Ignition**—opens a list of codes that set during the current ignition cycle.
- **MIL SVS or Message Requested**—displays ECM requests to light the malfunction indicator lamp (MIL) or service vehicle soon (SVS) lamp, or display a driver information alert.
- **Last Test Failed**—displays a complete list of failed tests.
- **Test Failed Since Code Cleared**—displays a list of tests that failed since the last time codes were cleared from ECM memory.

A code list includes the DTC and a brief description ([Figure 5-6](#)).

Code	Description
P0101	Mass Air Flow Circuit Range Or Performance
P0122	Throttle Position Sensor A Circuit Low Input
P0123	Throttle Position Sensor A Circuit High Input

Figure 5-6 Sample code list

## Clear Codes

The Scanner clears emissions-related codes from the control module memory on some vehicles. If this function is not available on the test vehicle, Clear Codes does not appear as a menu option.



### NOTE:

Clear Codes is also available from OBD-II Health Check (see [“OBD Health Check”](#) on page 40).



### To clear codes:

1. Select **Clear Codes** from the Codes Menu.  
A confirmation message displays.
2. Make sure any conditions shown on the confirmation message are met, then select **Yes**.  
A “codes cleared” message displays once the operation is complete.
3. Select **Continue** to return to the Codes Menu.

## Freeze Frame/Failure Records

This selection displays the DTC that was set, along with corresponding data, when the ECM commanded the malfunction indicator lamp (MIL) to turn on.

## Code Scan

One of the benefits of performing a code scan is that you can quickly show your customer diagnostic related issues with a pre scan report, and then after repairing the issues you can use the post scan report to show that the repairs were completed ([Figure 5-7](#)). In addition, by using ShopStream Connect the reports can be given to the customer and also saved for your own records, for more information, see [“ShopStream Connect”](#) on page 66.

**IMPORTANT:**

PRE / POST Scan Importance - As many systems do not turn on the check engine light or other indicator, performing a vehicle code scan before making any repairs may help in troubleshooting, by identifying possible unknown issues that may be related to the present symptoms.

Performing pre and post scans also allows you to record in report format the pre-condition of the vehicle and compare the post scan after work is complete to confirm the repairs were completed properly.

Pre and post scan is required by some manufacturers for pre and post collision work as well as by some insurance companies.

VEHICLE INFORMATION	
MAKE	Peugeot
YEAR	2009
MODEL	407
ENGINE	1.6L 16V T-Diesel (9HZ)
SYSTEM	



RESULT OF CODE SCAN	
	Systems detected : 11
	Engine Management - Codes : 2
	Transmission - Codes : 3
	Antilock Brakes - Codes : 1
	Airbag - Codes : 2
	Alarm - Codes : 3
	Battery Charge Status Unit (If Equiped) - Codes : 3
	Climate Control - Codes : 3
	Electric Steering - Codes : 3
	Tire Pressure Monitoring - Codes : 2
	Xenon/ Directional Lights Left - Codes : 3
	Xenon/ Directional Lights Right - Codes : 3
	Engine Management
P0117	Engine Coolant Temperature Signal, Short Circuit To Earth (Temperature Very High)
P0112	Inlet Air Temperature Signal (Flowmeter), Short Circuit To Earth
	Transmission
0FF2	Control Unit Fault No Signal
0FFF	Configuration Fault No Signal
U3003	Battery Voltage
	Antilock Brakes
C1383	Brake Fluid Level Switch Electrical Fault
	Airbag
B2666	Passenger's Seat Positon Sensor, Short Circuit To Battery
B160A	Rear Right Hand Side Airbag Present But Not Configured
	Alarm
0FF2	Control Unit Fault No Signal
0FFF	Configuration Fault No Signal
U3003	Battery Voltage
	Battery Charge Status Unit (If Equiped)

Figure 5-7 Typical Code Scan Report in Shopstream Connect



Depending on the vehicle, Code Scan (if supported) may be available from the Systems menu. Selecting **Code Scan** starts an active scan of vehicle control modules, and opens the Code Scan results screen (Figure 5-8). A progress indicator is shown at the top indicating the active scanning progress. Once completed, the results are displayed by system category.

The following Code Scan related control icons are used:

Icon	Function
	<b>Refresh</b> - Restarts the code scan
	<b>System</b> - Opens the main menu of the system selected

The following results are displayed progressively as the modules are scanned:

- **The total number of systems (modules) detected** (Figure 5-8).

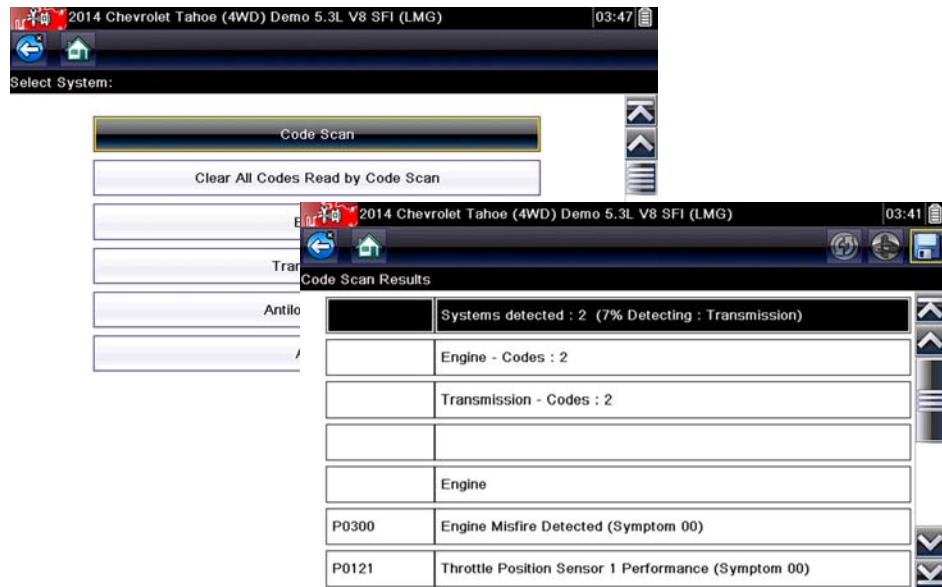

Figure 5-8 Code Scan systems analyzed result total

- **A list of all the systems analyzed with DTCs totals.** A categorized system list with DTC totals is displayed in the order they are scanned. To view the main menu for a system in the list, select the system, then select the **System** icon (Figure 5-9).



Figure 5-9 System icon (opens Main Menu)

### Saving Codes, and Code Scan Results)

When using the code scan feature, or when viewing individual system codes (e.g. engine, transmission) selecting the **Save** icon from the toolbar saves the results as a data file.

The saved file(s) can be viewed using two methods:

- On the diagnostic tool - See [“View Saved Data” on page 50.](#)
- Using ShopStream Connect - See [“ShopStream Connect” on page 66.](#)

### Printing the Code Scan Report

The vehicle system report can also be customized and printed using ShopStream Connect - See [“Printing the Code Scan Report” on page 70.](#)

### Clear All Codes Read by Code Scan

Selecting **Clear All Codes Read by Code Scan** erases all DTCs from all vehicle system modules that were read by Code Scan.



#### NOTE:

**Clear All Codes Read by Code Scan** may not clear global OBD-II codes on some vehicles.

## 5.3.2 Data Display

Select **Data** to view live datastream parameters from the vehicle ECM. In data display mode the screen has a toolbar and a main body (Figure 5-10).

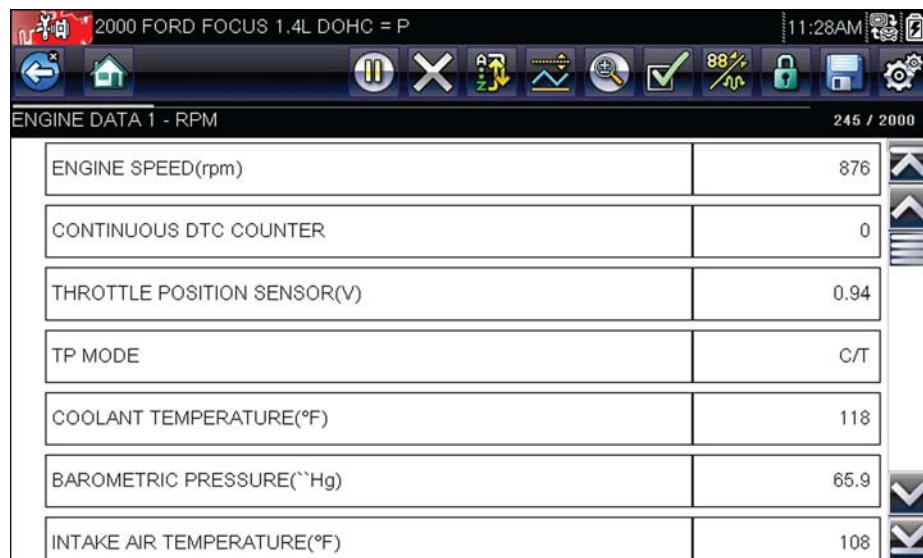

Parameter	Value
ENGINE SPEED(rpm)	876
CONTINUOUS DTC COUNTER	0
THROTTLE POSITION SENSOR(V)	0.94
TP MODE	C/T
COOLANT TEMPERATURE(°F)	118
BAROMETRIC PRESSURE("Hg)	65.9
INTAKE AIR TEMPERATURE(°F)	108

Figure 5-10 Sample data display screen

### Toolbar

The buttons on the toolbar operate as shown in Table 4-1 on page 17 while viewing data.

### Main Body

During data display the main body of the display is divided into two columns; the left-hand column displays a description of the parameter and the right-hand column shows the parameter value or state. Parameters are listed in the order in which they are transmitted by the ECM, so there will be variation between makes and models. Three parameters can be locked, or fixed, at the top of the list, so they do not change as you scroll through the parameter list in the lower frame. Use the **Lock/Unlock** button on the toolbar to select which parameters are fixed (see "Locking Parameters" on page 34).

### Pausing Data Collection

You may "pause" the collection of data from the vehicle control module. When data is paused, a number of previous frames of vehicle data, before was pause was selected, are stored in tool memory and are available for review.



#### To pause data collection:

1. While viewing live data, touch the **Pause** button.

On the toolbar, the Pause button replaces the Record button and the Previous Frame and Next Frame buttons display. A frame counter displays at the top of the main body of the screen, and a vertical line indicates your position in the graphs (Figure 5-11).

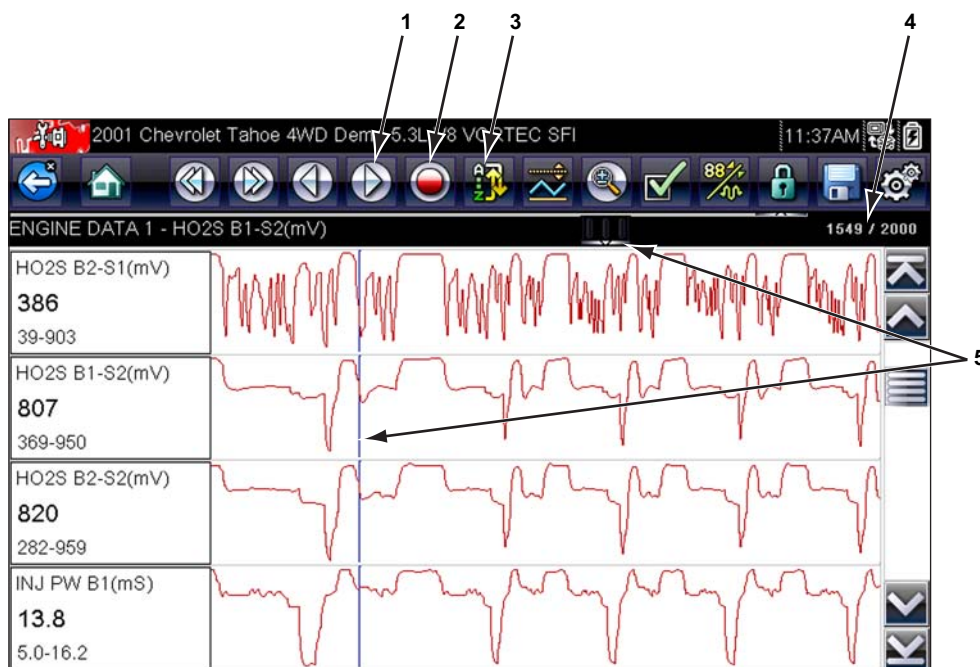

- 1— Previous Frame button
- 2— Next Frame button
- 3— Record button
- 4— Frame counter (current frame/total frames)
- 5— Position indicator

Figure 5-11 Sample paused frame of data

2. Scroll to review the data in the frame.
3. To switch frames, touch **Previous Frame** or **Next Frame**. Each button touch moves one frame in the selected direction.



**To resume collecting data:**

- Touch the **Record** button.  
The display changes to live data and the **Pause** icon is shown on the toolbar.



**NOTE:**

The **Shortcut** key can be set to perform the Pause/Play function. See [“Configure Shortcut Key” on page 54](#) for additional information.

## Sorting Data

The Sort button on the toolbar allows you to arrange the parameter list three ways

- Factory Sort—lists parameters in the order they are transmitted by the ECM
- A-Z Sort—lists parameters alphabetically in ascending order
- Z-A Sort—lists parameters alphabetically in descending order



### To sort the data list:

1. Select the **Sort** button on the toolbar.
2. Select a sort option from the dropdown menu using either the touch screen or the arrow and **Y/✓** keys.



---

### NOTE:

Any locked parameters are unlocked whenever a selection is made from the Sort button.

---

## Customizing the Data List

The **Custom Data List** button on the Scanner Toolbar is used to determine which specific parameters display. Minimizing the number of parameters on the data list allows you to focus on any suspicious or symptom-specific data parameters. You can add or remove most parameters from the list. Certain vital parameters cannot be removed. These appear in gray at the top of the list along with a lock icon and cannot be selected.

---

### IMPORTANT:

Limiting the number of parameters that displays to those that apply to a particular situation results in a faster data refresh rate, and reduces the amount of memory used for saved files.



---



### To create a custom data list:

1. Tap to select the **Custom Data List** button on the toolbar.  
The data selection screen displays and two new buttons appear on the toolbar. Check marks to the left of the parameter description indicates which parameters are selected for display. A second smaller check box indicates a parameter that is locked.

The toolbar buttons provide options for selecting and deselecting which parameters to include or remove from the custom data list:

Button	Description
	<b>Select/Deselect</b> , use to mark individual parameters to hide or display.
	<b>Select All/Deselect All</b> , use to hide or display all of the parameters in the list. Any locked parameters cannot be hidden.

2. Create a custom data list by touching the parameters to include. A parameter that displays has a check mark alongside the name, a parameter that does not display does not. Select which parameters to display:
  - a. Touching the **Select All/Deselect All** button immediately changes all of the parameters to the same condition, a second touch changes them all back.
  - b. Touching the **Select/Deselect** button activates it. Now you can add or remove parameters by touching individual entries in the list.

Keep the following in mind:

- Items at the top of the list that cannot be highlighted are locked and cannot be turned off.
- Use the Select All button to display the complete list.
- Use the Deselect All button to remove all of the highlights.
- Use the Cancel button to return to the data display.

3. Select **OK** to display the updated data list.

## Changing Screen Views

Selecting the **Graph** button opens a dropdown menu of options:

- PID List
- 1 Graph
- 2 Graph
- 4 Graph

The PID (parameter identification) List view is a 2-column display with the name of the parameters in the left column and their current values in the right column ([Figure 5-10](#)).

The 1, 2, and 4 Graph views divide the screen horizontally to simultaneously display data graphs of the indicated number of parameters in the main body of the screen ([Figure 5-12](#)). Use the scroll bar or the **up** (**▲**) and **down** (**▼**) keys to view other parameters.

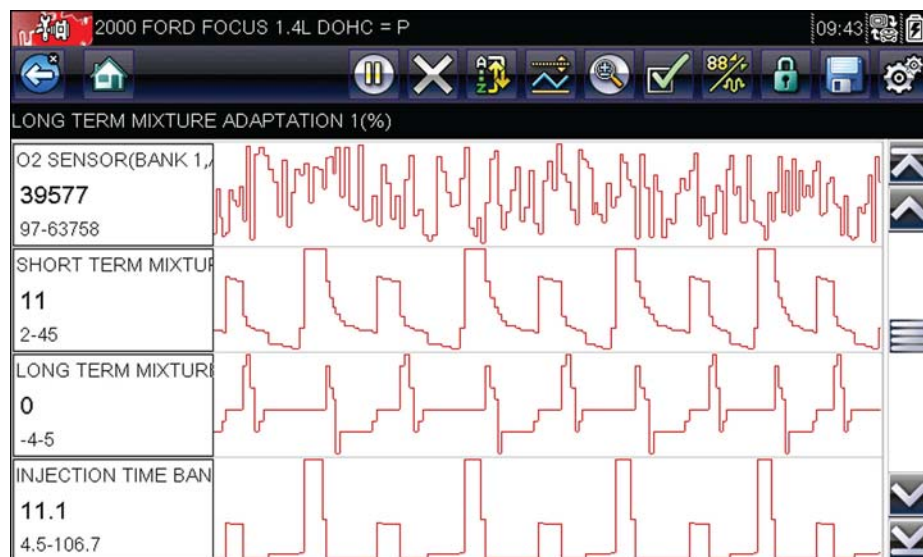

Figure 5-12 Sample 4 Graph view screen

Any previously set conditions, such as held data or locked lines of data, remain in effect when the screen view is changed.

## Locking Parameters

Use the **Lock/Unlock** button to lock selected lines of the data in place and prevent them from scrolling, or to release previously locked lines of data. Up to three lines of data may be held at a time. This feature allows you to position related parameters together, making it easier to monitor their values and spot inconsistencies.

Locked parameters display as the top frames on the main body of the display screen, as well as at their usual position in the data list (Figure 5-13). In PID List mode, a lock icon appears to the left of the parameter name to indicate it is locked.



### To lock parameters:

1. Highlight the parameter to be locked.
2. Tap the **Lock/Unlock** button on the toolbar to lock it.

A copy of the locked parameter is now shown at the top of the data list, and a lock icon appears alongside the parameter name if in PID List mode.

3. Highlight and select additional parameters to lock.

Up to three parameters can be locked at a time. Once locked, a parameter remains locked until it is manually unlocked or communication with the vehicle stopped.

COOLANT TEMPERATURE(*F)	
O2 SENSOR(BANK 1,BEFORE CAT)(mV)	1
O2 SENSOR(BANK 1,AFTER CAT)(mV)	12092
INJECTION TIME BANK 1(ms)	4.6
CONTINUOUS DTC COUNTER	0
THROTTLE POSITION SENSOR(V)	0.94
TP MODE	C/T
COOLANT TEMPERATURE(*F)	122

Figure 5-13 Sample locked parameters



**NOTE:**

If three parameters are locked, one of them must first be unlocked before another parameter can be locked.



**To unlock parameters:**

1. Scroll through the data list and highlight the parameter to be unlocked, or released.
2. Tap the **Lock/Unlock** button on the toolbar.  
The released parameter and the lock icon disappear from the list at the top of the data list.
3. Repeat Step 1 and Step 2 to release other parameters if needed.

## Saving

The **Save** button is used to record movies of vehicle datastream values into tool memory. Saving helps when trying to isolate an intermittent problem or to verify a repair during a road test. Saved files also provide documentation that helps you explain driveability problems to your customers.

A number of data movies can be stored, which can later be opened by selecting the Previous Vehicles and Data button on the home screen.

Saved files can also be downloaded from the scan tool to a personal computer (PC) through the Mini USB port. Once connected to the PC, SOLUS Ultra files can be printed, transferred, and copied using ShopStream Connect. ShopStream Connect is a PC application that creates an interface between the scan tool and a PC. The ShopStream Connect application is a free download available at: <http://diagnostics.snapon.com/SSC>.



**To save a movie:**

- Select **Save**.

A save movie dialog box displays while data is being saved. The movie is saved when the message box disappears.



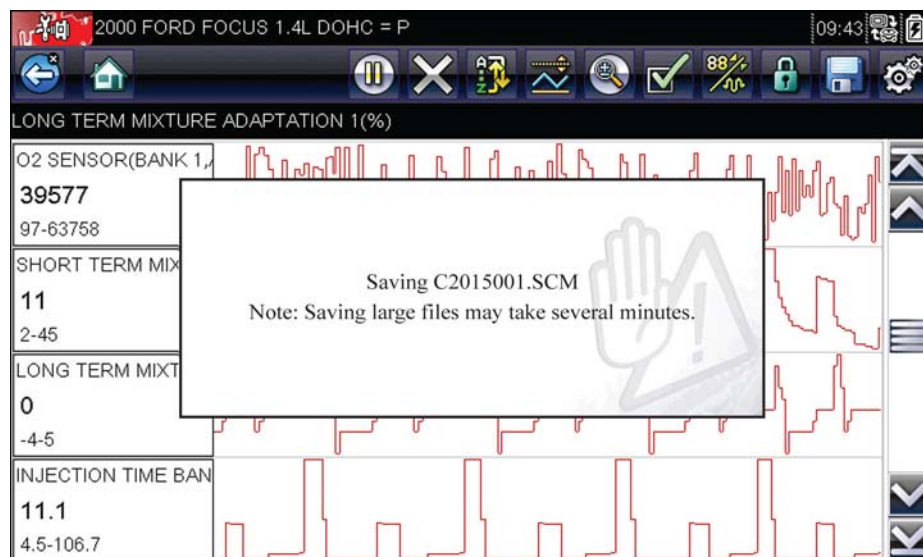

Figure 5-14 Sample save dialog box

The **Shortcut** key can be programmed to perform the Save Screen or Save Movie function. See [“Configure Shortcut Key” on page 54](#) for details.

## Setting Trigger Levels

The PID Trigger button on the toolbar allows you to configure the scan tool to automatically capture data when a parameter value crosses a threshold value. When triggering is armed, a “trigger event” pauses data collection and records a data movie, similar to an OBD-II/E OBD freeze-frame event.

Selecting the **PID Trigger** button opens a menu that includes:

- **Set Trigger**—establishes upper and lower signal values to initiate an event capture for the highlighted parameter.
- **Arm Trigger**—activates the scan tool to capture an event when the signal crosses a threshold.
- **Clear All Triggers**—deletes all previously set trigger levels.

If triggers are set the menu options are:

- **Clear Trigger**—deletes set trigger levels for the highlighted parameter.
- **Disarm Trigger**—de-activates event capture capability.
- **Clear All Triggers**—deletes all previously set trigger levels.



### To set trigger levels:

1. Highlight the parameter to be used to trigger the recording.
2. Tap the **PID Trigger** button.
3. Select **Set Trigger** from the dropdown menu.

A graph of the highlighted parameter with a trigger toolbar above it fills the main body of the screen. The trigger level line displays as a solid line running horizontally across the data graph ([Figure 5-15](#)). An upper and lower trigger level must be set, the upper level is set first.

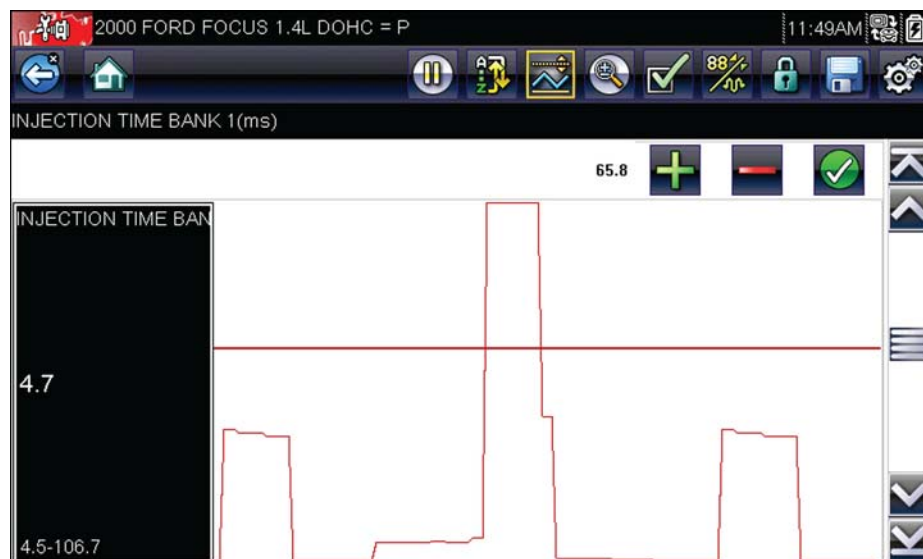

Figure 5-15 Sample trigger set screen

4. Tap the plus (+) and minus (-) buttons on the toolbar, or use the up ▲ and down ▼ arrow keys to position the upper trigger level to where you want it on the graph.
5. Tap the ✓ on the toolbar, or press the **Y/✓** key, to set the upper threshold.  
A lower trigger level line now appears at the mid-point of the graph.
6. Tap the plus (+) and minus (-) buttons on the toolbar, or use the up ▲ and down ▼ arrow keys to position the lower trigger level line to where you want it on the graph.
7. Tap the ✓ on the toolbar, or press the **Y/✓** key, to set the lower threshold.
8. Set the lower trigger level using the up ▲ and down ▼ arrows and press **Y/✓**.

The display returns to the live data view and the trigger points appear as horizontal lines across the designated parameter graphs. Repeat this procedure to establish trigger points for other parameters if desired. Once armed, any data points that register outside of your set conditions pause data collection and save a recording.



**NOTE:**

Only three parameters can have trigger levels set at one time, but only one of the conditions needs to be satisfied for triggering to occur.



**To arm triggers:**

1. Tap the **PID Trigger** button on the toolbar.
2. Select **Arm Triggers** from the dropdown menu.

The trigger lines on the data graphs change color to indicate an armed condition.

Triggers for all of the graphs are armed simultaneously. Once triggering is armed, it remains in that state until you switch it off. If trigger settings are modified or are added for other parameters, they are armed as soon as you exit the setting screen.

### 5.3.3 Functional Tests

The **Functional Tests** selection is used to access vehicle-specific subsystem and component tests. Available tests vary by manufacturer, year, and model, and only the available tests display in the menu.





There are four general types of functional test operations:

- **Information Tests**—are read-only tests, like selecting “VIN” from a Functional Tests menu to display the VIN of the identified vehicle.
- **Toggle Tests**—switch a component, such as a solenoid, relay, or switch, between two operating states.
- **Variable Control Tests**—command a certain value for a system or component, such as varying the spark timing in 1° increments or the EGR valve duty cycle in 10% increments.
- **Reset Tests**—reset the adaptive, or learned, values that are stored in the control module.
- **Scripted Tests**—are software routines that place the test vehicle into special operating modes for performing certain repairs, such as a brake bleeding sequence.

Selecting Functional Tests opens a menu of test options that varies by make and model. Selecting a menu option either activates the test or opens a submenu of additional choices. Follow all screen instructions while performing tests. How and what information is presented on the screen varies according to the type of test being performed.

Some toggle and variable control tests display functional test controls at the top of the screen with datastream information below. Functional test controls allow you manipulate the test signal as shown in Table 5-1.

**Table 5-1** Functional test control buttons

Name	Button	Description
OK		Activates the test.
Cancel		Cancels the test.
Minus		Switches an item off or low, or incrementally reduces a variable signal.
Plus		Switches an item high or on, or incrementally increases a variable signal.

### 5.3.4 Troubleshooter

Fast-Track® Troubleshooter is a database of experience-based information. The database is composed of validated real-world repair strategies that have been compiled by top-notch technicians since 1988. The Troubleshooter system simplifies the diagnosis process, as it contains information on virtually all common diagnostic trouble code (DTC) problems and driveability symptoms for most vehicles covered by the vehicle communication software.

Information is organized into a series of diagnostic tips that are designed to quickly lead you to the root cause of a particular problem. The tips are vehicle-specific, which means only tips that relate to the identified vehicle are presented. Selecting opens a menu that typically includes:

- **Code Tips**—provides detailed information on setting conditions, testing, and interpreting test results for specific codes.
- **Symptom Tips**—provides diagnostic tests and procedures based on vehicle operation.
- **Time Savers**—provides supplemental information, such as firing order and #1 cylinder location, that may be needed to make a diagnosis.
- **Common Problems**—provides advice and remedies for certain “pattern failures” that have been experienced on vehicles of the same model.
- **Tests and Procedures**—explains how to perform certain tests on the specific test vehicle. Some tips provide specifications and installation information as well.
- **Fast-Track Data Scan (Normal Values)**—contains information and guidelines on how to quickly validate data readings for certain sensors and actuators, live data values are provided for comparison.

Certain live data parameter values display directly within the tip when performing Troubleshooter tests and procedures. A tip may also contain a hyperlink to a another test or procedure or a supplemental operation, such as Clear Codes. Hyperlinks are shown in blue, and tapping them opens the link.

## 5.4 Exiting the Scanner

The Scanner remains open as long as there is an active communication link with the vehicle. You must interrupt this communication link in order to exit from Scanner tests and power down the scan tool. A warning message displays if you attempt to shut down while the Scanner is communicating with the vehicle.



### NOTE:

Damage to the vehicle electronic control module (ECM) may occur if communication is disrupted. Make sure the data cable is properly connected at all times during testing. Exit all tests before disconnecting the test cable or powering down the tool.

---



### To exit the Scanner:

1. From an active screen, select **Exit** from the Scanner Toolbar to return to the Systems Menu.
2. From the Systems Menu, select **Back** from the Scanner data menu.

A “stopping communications” message briefly displays followed by the Scanner main menu.

Now, the Scanner is no longer communicating with the vehicle and it is safe to return to the Home screen and power down the scan tool.

This Home screen option allows you to access Generic OBD-II/EOBD Scanner tests without completing a vehicle identification. This option presents a quick way to check for diagnostic trouble codes (DTCs), isolate the cause of an illuminated malfunction indicator lamp (MIL), check monitor status prior to emissions certification testing, verify repairs, and perform a number of other services that are emissions-related. OBD-II/EOBD is also used for testing OBD-II compliant vehicles that are not included in the Scanner databases.

OBD-II/EOBD is a Scanner function, and the scan tool must be connected to the test vehicle and communicating with the display device. Keep in mind, this function provides generic OBD-II information only. Select from the Vehicle Manufacturers Menu for enhanced OBD-II functions.

Selecting OBD-II/EOBD on the Home screen opens a menu with two options:

- OBD-II Health Check
- OBD-II Diagnose

## 6.1 OBD Health Check

The OBD-II Health Check offers a way to quickly check for and clear generic diagnostic trouble codes (DTCs) and to check readiness monitors. Selecting opens a connection message, then a submenu of test options (Figure 6-1).



Figure 6-1 Sample OBD Health Check menu

## 6.1.1 Global OBD II Code Check

The Code Check displays stored emission related generic DTCs reported by the ECM. Selecting this option opens a submenu with two choices: Codes and Pending Codes. Select an option to display the code list.

DTC List	
P0108	Manifold Absolute Pressure/BARO Sensor High
P0104	Mass or Volume Air Flow A Circuit Intermittent/Erratic
P0102	Mass or Volume Air Flow A Circuit Low
P0104	Mass or Volume Air Flow A Circuit Intermittent/Erratic
P0110	Intake Air Temperature Sensor 1 Circuit (Bank 1)

Figure 6-2 Sample code list

### Codes

The Codes option displays a list of current emission related DTCs.

OBD-II/EOBD Codes have a priority according to their emission severity, with higher priority codes overwriting lower priority codes. The priority of the code determines the illumination of the MIL and the code erase procedure. Vehicle manufacturers have implemented the ranking differently, so there are differences between makes.

### Pending Codes

The purpose of this service is to enable the scan tool to obtain “pending” or maturing diagnostic trouble codes. These are codes whose setting conditions were met during the last drive cycle, but need to be met on two or more consecutive drive cycles before the DTC actually sets.

The intended use of this service is to assist the service technician following a vehicle repair and code clearing procedure by reporting test results after a single drive cycle.

- If a test failed during the drive cycle, the DTC associated with that test is reported. If the pending fault does not occur again within 40 to 80 warm-up cycles, the fault is automatically cleared from memory.
- Test results reported by this service do not necessarily indicate a faulty component or system. If test results indicate another failure after additional driving, then a DTC is set to indicate a faulty component or system, and the MIL is illuminated.

Refer to and the *Global OBD Vehicle Communication Software Manual* for additional information.

### 6.1.2 Global OBD II Clear Codes

This option is used to clear all emission related diagnostic data, such as DTCs, freeze frame data, and test results, from the memory of the selected ECM. Although OBD-II/EOBD only displays generic OBD-II/EOBD data, clearing codes erases all of the stored data, including any enhanced codes and freeze frame information.

A confirmation screen displays when the clear codes option is selected to prevent accidental loss of data. Select Yes on the confirmation screen to continue. Refer to and the *Global OBD Vehicle Communication Software Manual* for additional information.

### 6.1.3 Readiness Monitors

Use this menu option to check the readiness of the monitoring system. An OBD-II /EOBD system checks the status of emission-related subsystems by running continuous or periodic tests. Two viewing options are available once Readiness Monitors is selected:

- **Monitors Complete Since DTC Cleared**—displays the status of all monitors that have run since the last time DTC were erased from PCM memory.
- **Monitors Complete This Cycle**—displays the status of the monitors that ran during the current drive cycle only.

Select either option and test results are shown in the data viewer (Figure 6-3).

OBD-II/EOBD		03:33PM
ID : \$	10	139 / 2000
MISFIRE	TEST COMPLETE	
FUEL SYSTEM	TEST COMPLETE	
COMPONENTS	TEST COMPLETE	
CATALYST	NOT COMPLETE	
HEATED CATALYST	NOT SUPPORTED	
EVAPORATIVE SYSTEM	NOT COMPLETE	

Figure 6-3 Sample readiness monitor test report

Scroll to view the entire list of Readiness Monitors to ensure that all tests are complete. It is possible to save the monitor report as part of the vehicle records.

### 6.1.4 Connector Information

This option opens a database of vehicle diagnostic connector locations that includes most makes and models. The menu driven interface leads you quickly to the difficult to find test connector.

**To locate a vehicle diagnostic connector:**

1. Select **Connector Information** from the System menu.  
A list of vehicle manufacturers displays.
2. Select a manufacturer from the list.  
A list of models available from the selected manufacturer displays.
3. Select a model from the list.  
Instructions for which, if any, cable adapter to use display.
4. Select **Continue**.  
Information on where to locate the vehicle diagnostic connector displays.

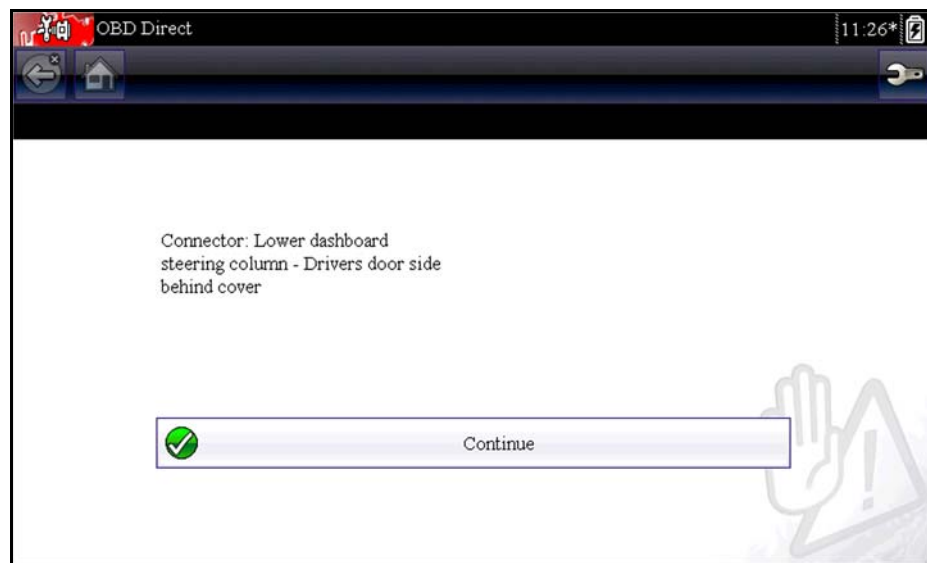

Figure 6-4 Sample diagnostic connector location

5. Select **Continue** to return to the System menu.

## 6.2 OBD Diagnose

Selecting OBD Diagnose opens a menu with the following options:

- **Start Communication**—initiates a test session
- **Select Communication Protocol**—establishes which communication protocol to use
- **Connector Information**—provides data link connector (DLC) location details

### 6.2.1 Start Communication

Use the following procedure to begin an OBD-II/EOBD test session:





### To perform an OBD-II/EOBD Test:

1. Select **Start Communications** from the OBD-II/EOBD menu.

A vehicle type options list displays:

- 12V Light Duty Vehicle
- 24V Heavy Duty/Goods Vehicle

2. Select an option from the vehicle type list.

A connection message displays.

3. Connect the data cable to the test vehicle, then select **Continue**.

The scan tool establishes a communication link with the test vehicle, then displays an information screen that shows how many control modules were detected, which ECM is communicating, and which communication protocol is being used (Figure 6-5).

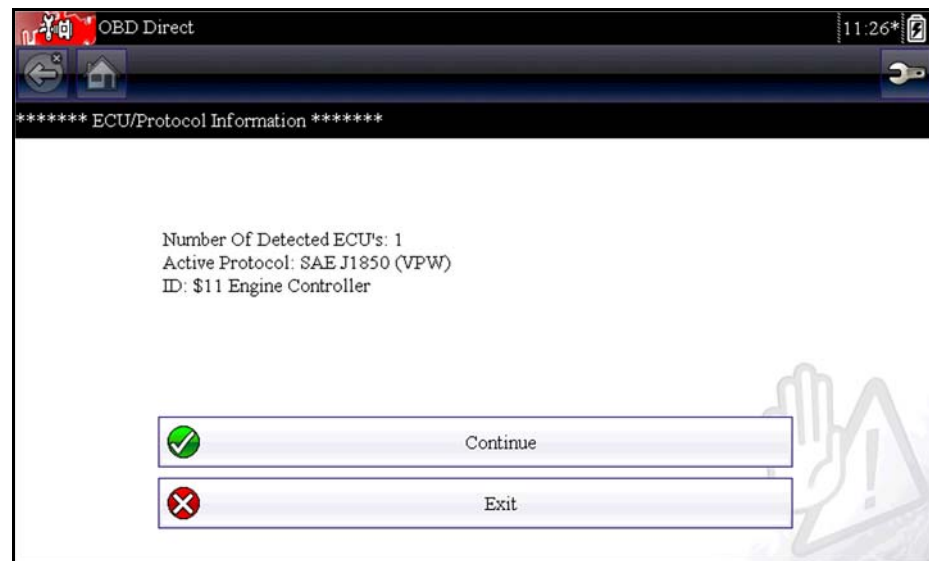

Figure 6-5 Sample protocol information screen

4. Select **Continue**.

A Select Service menu of available tests displays, options include:

- Readiness Monitors
- MIL Status
- Display Current Data (\$01)
- Clear Emissions Related Data (\$4)
- Display Freeze Frame Data (\$02)
- Display Trouble Codes (\$03)
- Display Test Parameter/Results (\$05, 06, 07)
- Request Control of On-Board System (\$8)
- Read Vehicle Identification (\$09)
- Emission Related DTC with Permanent Status (\$0A)

---

#### IMPORTANT:

All service modes are not supported by all vehicles, so the available menu selections will vary.

---

5. Select a test to continue.

## Readiness Monitors

Use this menu item to check the readiness of the monitoring system. If a monitor system is not supported, it is not displayed. Scroll, if needed, to view the entire list of monitors (Figure 6-3). Selecting Readiness Monitors opens a submenu with two choices:

- **Monitors Complete Since DTC Cleared**—displays the results of all monitor tests that have run since the last time the electronic control module (ECM) memory was cleared.
- **Monitors Complete This Cycle**—displays only the results of monitor tests that ran during the current drive cycle, they reset when the ignition is switched off.

## MIL Status

This item is used to check the current condition of the Malfunction Indicator (MIL). Additional information, such as which ECM commanded the MIL on and the distance driven while the MIL is on (if supported), can also be displayed. It is also possible to save the MIL Status report.

## (\$01) Display Current Data

Use this item to display the current emission related data from the selected electronic control module (ECM) of the vehicle. Displayed data includes analog inputs and outputs, digital inputs and outputs, and system status information broadcast on the vehicle data stream ( ).



Parameter	Value
ID : \$	10
ENGINE SPEED(1/min)	0
ABSOLUTE THROTTLE POSITION(%)	0.0
FUEL SYSTEM 1	OPEN LOOP
FUEL SYSTEM 2	NOT USED
INTAKE AIR TEMPERATURE(°F)	-40
ENGINE COOLANT TEMPERATURE(°F)	-40

Figure 6-6 Sample current data display

## (\$02) Display Freeze Frame Data

This item is used to display freeze frame data for any stored emission related diagnostic trouble code (DTC). In most cases the stored frame is the last DTC that occurred. Certain DTCs, those that have a greater impact on vehicle emission, have a higher priority. In these cases, the highest priority DTC is the one for which the freeze frame records are retained.

Freeze frame data includes a “snapshot” of critical parameter values at the time the DTC set.

### (\$03) Display Trouble Codes

This is used to display any stored emission related DTCs reported by the ECM. The display is similar to a Scanner code display, but does not include any enhanced DTCs.

### (\$04) Clear Emissions Related Data

This item is used to clear all emission related diagnostic data, such as DTCs, freeze frame data, and test results, from the memory of the selected ECM. Selecting opens a confirmation message (Figure 6-7).

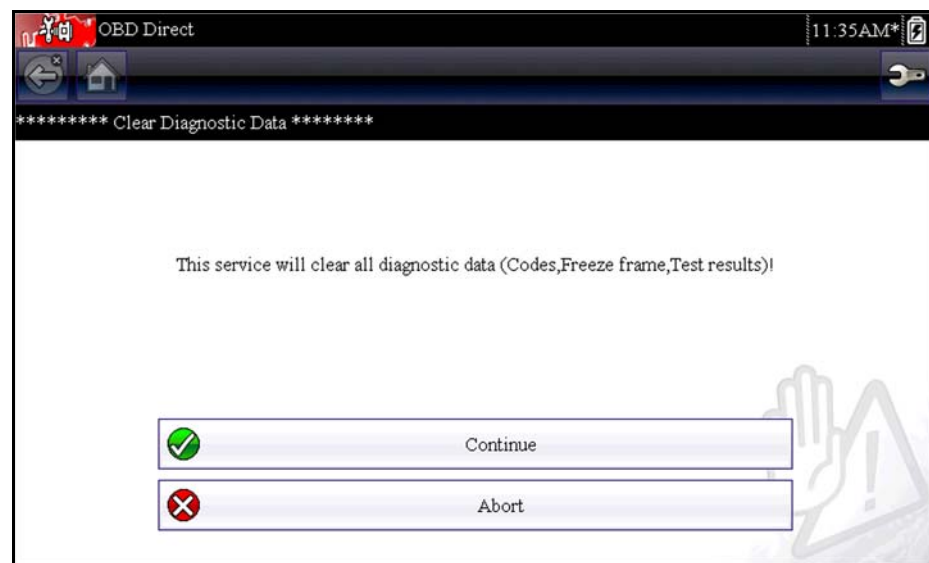

Figure 6-7 Sample clear codes confirmation

Continue from the confirmation message and the screen updates several times as ECM memory is erased, then a “data has been cleared” message displays. Select **Continue** to return to the Select Service menu.

### (\$05, 06, 07) Display Test param./Results

This selection opens a submenu of test parameters and test results from various sensors, monitor test results, and a record of DTCs detected during the last drive cycle. The menu includes:

- (\$05) Oxygen Sensor Monitoring
- (\$06) Specific Monitored Systems
- (\$07) DTCs Detected During Last Drive

#### (\$05) Oxygen Sensor Monitoring

This selection opens a menu of tests available for checking the integrity of the oxygen sensors. Making a selection displays all of the pertinent O2S parameters for the specific test. The test identification (ID) displays at the top of the data list.

### **(\$06) Specific Monitored Systems**

This selection opens a menu of available test results on monitored systems. The data available is for specific systems and components that the onboard diagnostic system either continuously monitors, such as misfire, or non-continuously monitors, such as the catalyst system. Making a selection displays the test results.

### **(\$07) DTCs Detected During Last Drive**

This selection opens a record of any DTCs that set during the last completed drive cycle. Select to open the DTC list.

### **(\$08) Request Control of On-board System**

This service enables bidirectional control of the ECM. The purpose of this service is to allow the Scanner to control the operation of an onboard system, test, or component. Select a test and follow the on-screen instructions.

### **(\$09) Read Vehicle Identification**

The purpose of this service is to enable the Scanner to request and display vehicle-specific information, such as the vehicle identification number (VIN), the calibration identification, and the calibration verification number (CVN), of the test vehicle. Select a menu item to retrieve the identification information. Select **Return** to go back to the menu.

### **(\$09) In-use Performance Tracking**

This selection displays the “In-use Performance Tracking” of data. It is basically a record of the number of times each of the monitor tests have been completed. Select **Return** to go to the menu.

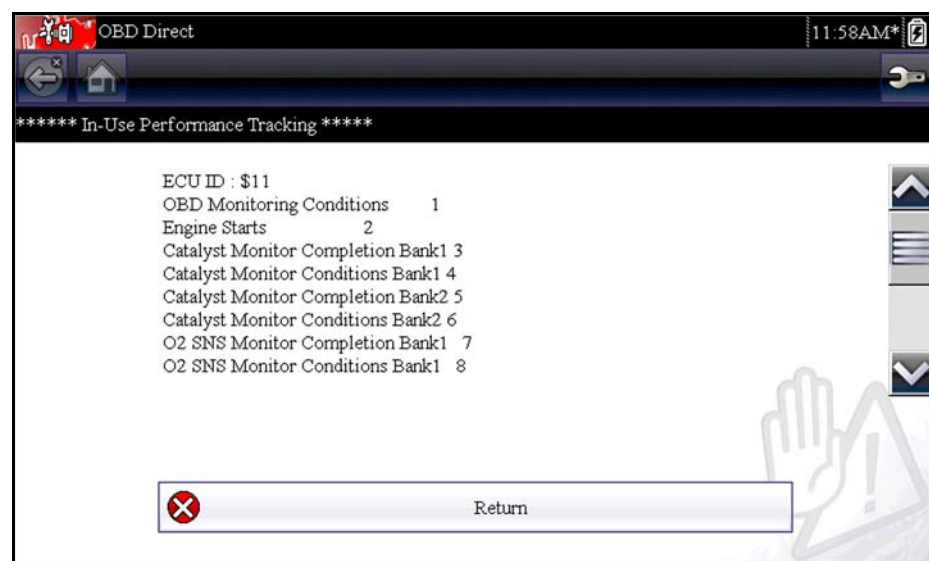

Figure 6-8 Sample performance tracking display

## (\$0A) Emission Related DTC with Permanent Status

This selection displays a record of any “permanent” codes. A permanent status DTC is one that was severe enough to illuminate the MIL at some point, but the MIL may not be on at the present time. Even though the MIL may have been switched off by clearing codes or because the setting conditions did not repeat after a specified number of drive cycles, a record of the DTC is retained by the ECM. Permanent status codes automatically clear after repairs have been made and the related system monitor runs successfully.

## 6.2.2 Select Communication Protocol

A communication protocol is a standardized way of data communication between an ECM and a scan tool. Global OBD may use the following communication protocols:

- ISO 9141-2 (K-LINE)
- SAE J1850 PWM (Pulse Width Modulation)
- SAE J1850 VPW (Variable Pulse Width)
- ISO 14230-4 (Keyword Protocol 2000)
- SAE J2284/ISO 15765-4 (CAN)

Touch **Select Communication Protocol** to open a menu of options (Figure 6-9).



Figure 6-9 Sample communication protocol menu

When the All Protocols setting is used the Scanner attempts to establish communication using each protocol in order to determine which one the vehicle is broadcasting on. Select **Back** or press the **N/X** key to return to the OBD-II/EOBD Main menu.

## 6.2.3 Connector Information

Opens the connector database discussed in "[Connector Information](#)," on page 42.

The Previous Vehicles and Data Home screen selection allows you to quickly configure the scan tool to the identity of a recently tested vehicle, and to access saved data files. A menu with three options opens when **Previous Vehicles and Data** is selected:

- Vehicle History
- View Saved Data
- Delete Saved Data

## 7.1 Vehicle History

The scan tool stores the identification of the last twenty-five vehicles tested, so there is no need to go through the complete vehicle identification sequence when performing a retest after repairs have been made. The oldest vehicle record is deleted when a new vehicle is identified once there are twenty-five vehicles on file.



Figure 7-1 Sample vehicle history list



### To select from the vehicle History:

1. Select **Previous Vehicles and Data** from the Home screen.
2. Select **Vehicle History** from the menu.

A list of up to 25 previously tested vehicles displays. Each vehicle is given a unique file name that includes the vehicle ID, date, and time. Use the scroll bar to view the entire list.

3. With the item to be opened highlighted, either tap the vehicle ID or press the **Y/✓** key.  
The appropriate software loads and a vehicle ID confirmation screen displays.
4. Select **OK** or press **Y/✓** to continue.

A connection message displays.

5. Connect the data cable to the vehicle, then select **OK** or press **Y/✓** to continue.  
The menu for the last system tested on the selected vehicle displays.

## 7.2 View Saved Data

Selecting the **View Saved Data** menu option opens a list of all the data movies and screen images that are stored in the scan tool memory. Saved files are listed in chronological order by the date and time that they were created with the most recent files are at the top of the list. The vehicle ID characteristics are included in the listings as well.



Figure 7-2 Sample saved data list

Saved files can either be opened directly on the scan tool, or downloaded to a personal computer and opened using ShopStream Connect software.



### To review a movie:

1. Select **Previous Vehicles and Data** from the Home screen.
2. Select **View Saved Data** from the menu.
3. Select a movie from the list of saved files.

The movie opens and plays in real time. The **Play** button changes to the **Pause** button at the end of the movie.

Movie reviewing tips:

- The **Pause/Play** and **Graph** toolbar buttons are active while a movie is playing, so you can stop the movie or switch to graph view at any time.
- The **Previous Frame** and **Next Frame** buttons are active if the data is paused.

## 7.2.1 Viewing Codes and Code Scan Results

When code scan or single system code results are saved, they are saved in (.XML) file format (Figure 7-3).



Figure 7-3 Typical - Code Results (.XML) file

The saved (.XML) file(s) can be viewed using these methods:

- On the diagnostic tool - See "[Viewing Code Results on the Diagnostic Tool](#)," on page 52.

In report format using:

- ShopStream Connect - see "[Printing the Code Scan Report](#)," on page 70.



### Viewing Code Results on the Diagnostic Tool

Selecting a system code or a code scan results file from your saved file list (Figure 7-4), opens the file onscreen. When opened, the (.XML) file displays basic vehicle information and a list of DTCs with a brief description of each.

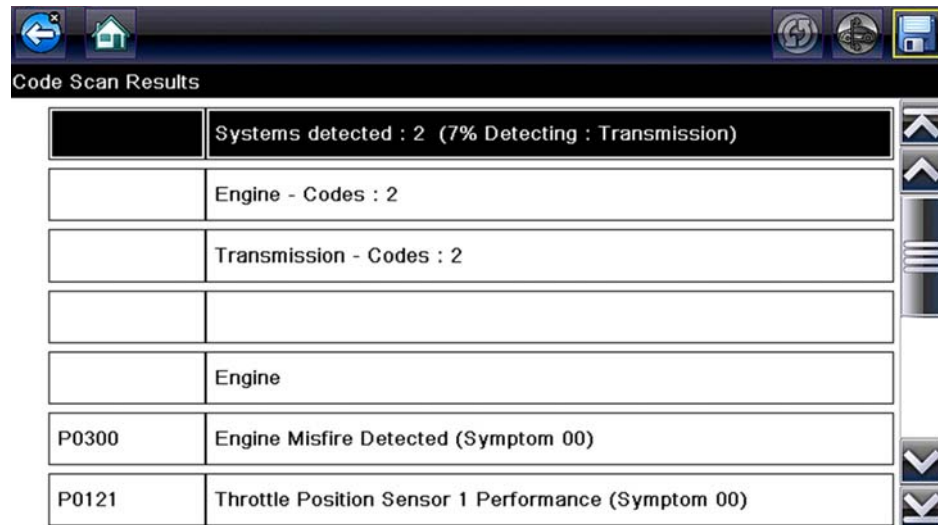

Figure 7-4 Typical - Code Scan Results (.XML file) viewed onscreen

## 7.3 Delete Saved Data

This menu option is used to permanently erase saved files from scan tool memory when they are no longer needed.

### To delete a saved file:

1. Select **Previous Vehicles and Data** from the Home screen.
2. Select **Delete Saved Data** from the menu.  
A list of saved files displays.



#### NOTE:

The Select/Deselect and Select All/Deselect All buttons become available on the toolbar so that you can either delete individual files or clear the entire memory buffer all at once.

3. Select a file from the list and a confirmation message displays.
4. Select an option from the confirmation message:
  - **OK**—deletes the selected file and returns to the saved files list, which no longer includes the deleted file.
  - **Cancel**—returns to the saved files list without deleting the selected file.
5. Select **Back** on the toolbar to return to the Previous Vehicles and Data menu, select **Home** to return to the Home screen.

The Tools option on the home screen is used to configure the scan tool for your personal preferences. Tap the **Tools** button to open a menu of options.



Figure 8-1 Sample Tools menu

## 8.1 Tools Menu

The following options are available from the Tools menu:

- **Connect To PC**—use to transfer and share files with a personal computer (PC)
- **Configure Shortcut Key**—use to change the functionality of the shortcut key
- **System Information**—use to display configuration information for your scan tool
- **Settings**—use to configure certain characteristics of the scan tool

### 8.1.1 Connect to PC

**Connect-to-PC** allows you to transfer saved data files on your diagnostic tool to your personal computer using a USB cable.

The optional ShopStream Connect™ PC software allows you to view, print and save data files on your PC. In addition, you can download software updates from the PC to the diagnostic tool. These features provide an ideal way to manage saved data files. The ShopStream Connect application is available free online, see "[ShopStream Connect](#)," on page 66 for additional information.



### To connect the diagnostic tool to a PC:

1. Connect the supplied USB cable to the diagnostic tool and then to the PC.  
A USB cable, supplied with your diagnostic tool, is used to connect the diagnostic tool to the PC. When the diagnostic tool is connected to the PC a communications icon appears on the right edge of the title bar.
2. Select **Tools** from the Home screen.
3. Select **Connect-to-PC** from the Tools and Setup menu.  
A screen message will display to confirm the tool is in Connect-to-PC-mode.



This device is now in Connect-to-PC mode.

Press to exit.



Figure 8-2

## 8.1.2 Configure Shortcut Key

This feature allows you to change the functionality of the **Shortcut** key. Options are:

- **Brightness**—increases the screen backlighting in incremental steps from lowest to highest, then returns to the lowest setting and continuously repeats.
- **Save Screen**—takes a snapshot of the current screen as either a bitmap or jpeg image. A snapshot includes the visible screen image only.
- **Save Movie**—saves a recording of a number of frames of data (buffered data plus data transmitted after triggering) for each available parameter.
- **Show Shortcut Menu**—opens the Configure Shortcuts menu when the Shortcut key is pressed so you can quickly select from any of the available functions.
- **Toggle Record/Pause**—programs the Shortcut key to work as the Pause and Play buttons, the first press pauses data collection and the second press resumes live data.



### To assign a function to the Shortcut key:

1. Select **Tools** from the Home screen.  
The Tools menu opens.
2. Select **Configure Shortcut Key** from the menu.
3. Select a function from the menu.
4. Select the **Back** on the toolbar or press the **N/X** key to return to the options menu.

### 8.1.3 System Information

The **System Information** option lets you view configuration information for your scan tool.



**To display the System information screen:**

1. Select **Tools** from the Home screen to open the menu.
2. Select **System Information** from the menu.

The System Information screen displays.



**Figure 8-3** Sample system information screen

3. Select **Back** on the toolbar or press the **N/X** key to return to the options menu.

### 8.1.4 Settings

This Tools selection allows you to adjust certain basic diagnostic tool functions to your personal preferences. Selecting opens an additional menu that offers the following:

- ["System Settings," on page 55](#)
- ["Configure Scanner," on page 61](#)
- ["Configure Units," on page 62](#)

#### System Settings

Selecting System Settings opens a menu with two options; Display and Date & Time. Either selection opens an additional menu.

Display options include:

- "Brightness," on page 56—adjusts the intensity of the screen back lighting.
- "Color Theme," on page 57—changes the background color of the screen display.
- "High Contrast Toolbar," on page 57—enhances toolbar graphics for poor lighting conditions.
- "Font Type," on page 58—switches between standard and bold text for better visibility.
- "Backlight Time," on page 58—adjusts how long the screen stays on with an idle unit.
- "Touch Calibration," on page 58—calibrates the touch screen display.

Date & Time options include:

- "Time Zone," on page 59—sets the internal clock to the local time standard.
- "Clock Settings," on page 59—sets the time on the internal clock.
- "Daylight Savings Time," on page 60—configures the clock for Daylight Savings Time.
- "Time Format," on page 60—switches the time displays between a 12 or 24 hour clock.
- "Date Format," on page 61—configures how the month, date, and year displays.

### **Brightness**

Selecting this option opens the brightness setting screen for adjusting the back lighting of the display (Figure 8-4).

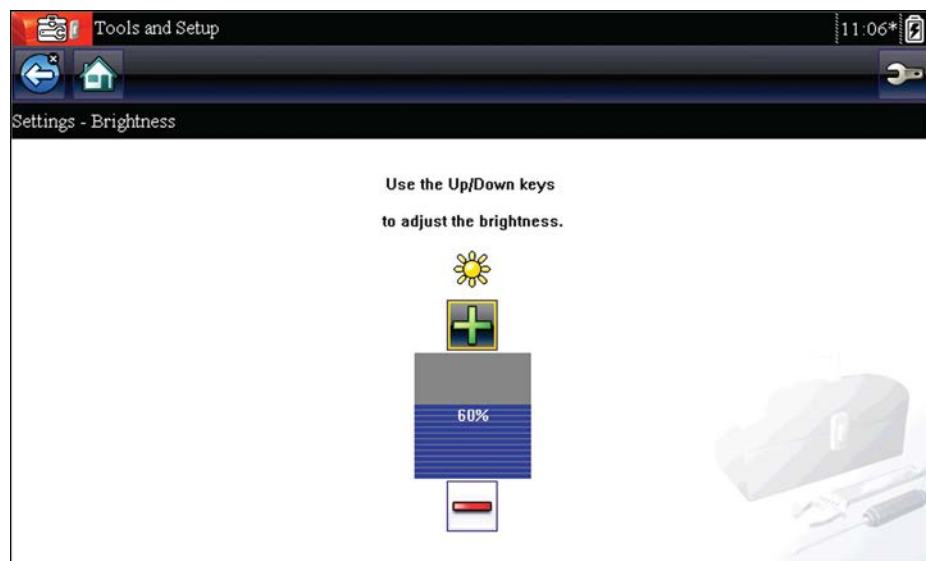

Figure 8-4 Sample brightness setting screen

Each tap of the **Plus** and **Minus** buttons, or the up (▲) and down (▼) arrows, incrementally changes the back lighting up or down respectively.

Select **Back** from the toolbar or press the **N/X** key to exit.

### Color Theme

This option allows you to select between a white and black background for the screen. The black background can be beneficial when working under poor lighting conditions.

Selecting opens a menu with two choices: **Day Theme** (white background) and **Night Theme** (black background). Make a selection and a “please wait” message momentarily displays followed by the Home screen. The new toolbar setting is now active.

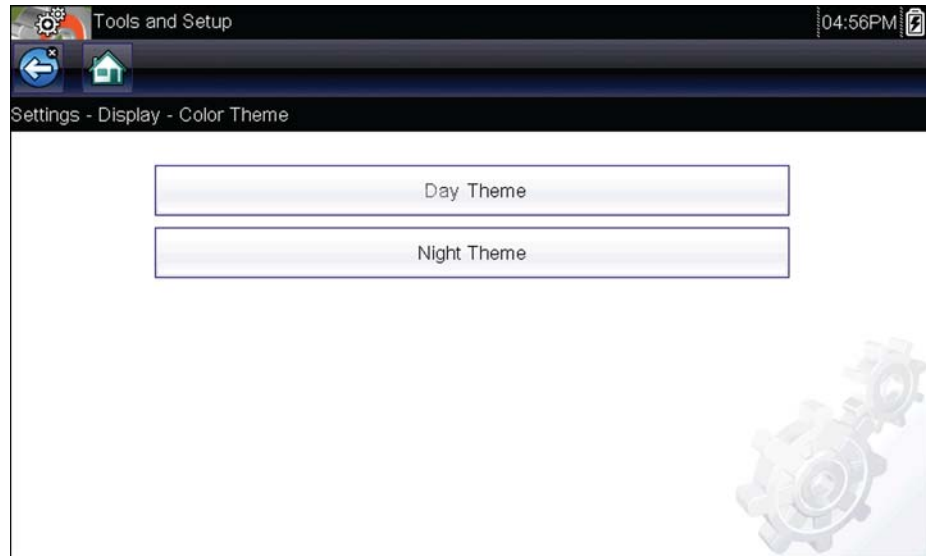

Figure 8-5 Sample Night Theme menu screen

### High Contrast Toolbar

This option allows you to switch to a high contrast toolbar. This toolbar features black and white buttons with crisp graphics that are easier to see in poor lighting conditions or bright sunlight.

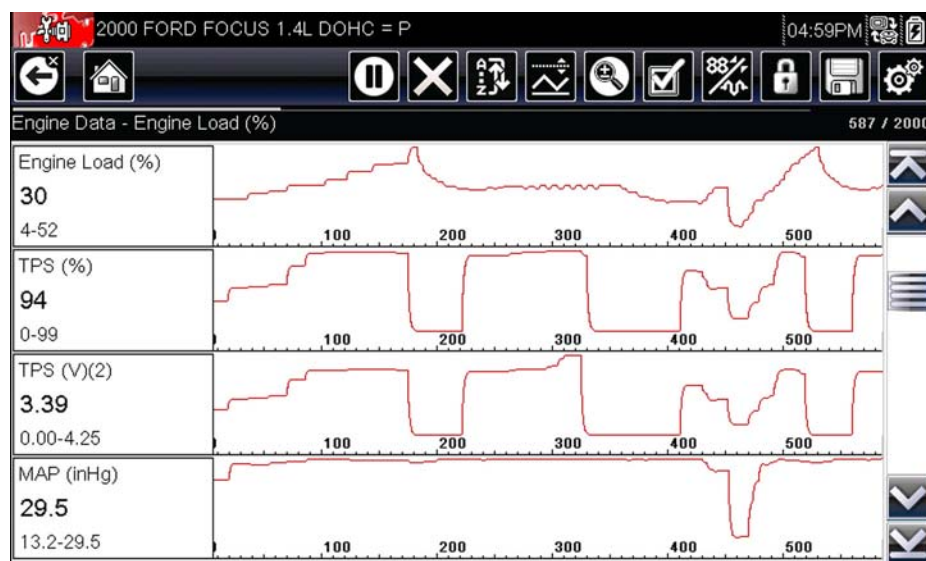

Figure 8-6 Sample high-contrast toolbar

Selecting opens a menu with two choices; Color Toolbar and High Contrast Toolbar. Select and a “please wait” message displays followed by the Home screen. The new setting is now active.

### **Font Type**

This option allows you to select between standard and bold faced type for the display screen. Bold type makes screen writing more legible under poor lighting or bright sunlight conditions.

Selecting opens a menu with two choices: Normal Font and Bold Font. Tap a menu item, or scroll with the keypad and Press **Y/✓**, to make a selection. The change is instantaneous. Select the Back or Home button on the toolbar to return to either the Settings menu or the Home screen.

### **Backlight Time**

This option allows you to configure how long the screen backlight remains on when the tool is inactive. The following choices are available:

- Always On
- 15 Seconds
- 30 Seconds
- 45 Seconds
- 60 Seconds

Tap the menu item desired, or scroll with the keypad and Press **Y/✓**, to make a selection. Select **Back** or **Home** on the toolbar to return to either the Settings menu or the Home screen.

### **Touch Calibration**

Calibrating the touch screen maintains the accuracy of the touch-sensitive display. Perform the following procedure on a routine basis to keep your diagnostic tool in good working order.



#### **To calibrate the touch screen:**

1. Select **Tools** from the Home screen to open the menu.
2. Select **Settings** from the menu.
3. Select **Touch Calibration** from the menu.

The calibration screen opens ([Figure 8-7](#)).

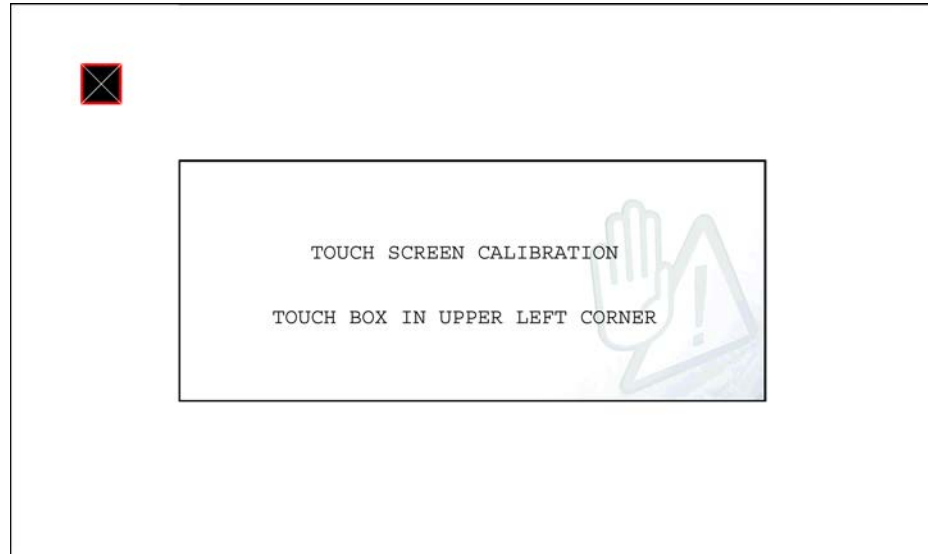

Figure 8-7 Sample calibration screen

4. Touch each box on the screen as it displays.  
The display returns to the Settings menu once the screen calibration procedure is complete.

---

**IMPORTANT:**

It is critical to complete the touch screen calibration sequence once it has begun. Never power down the unit while a screen calibration is in process, serious damage to the unit may result.

---

### ***Time Zone***

This option opens a menu of time zone settings. Scroll to highlight, then select the local time zone. The display returns to the Settings menu once a time zone is selected.

### ***Clock Settings***

This option opens a window for resetting the time on the real-time clock.



**To set the clock:**

1. Select **Tools** from the Home screen to open the menu.
2. Select **Settings** from the menu.
3. Select **Clock Settings** from the menu.

A warning message briefly displays followed by the Clock Settings screen ([Figure 8-8](#)).



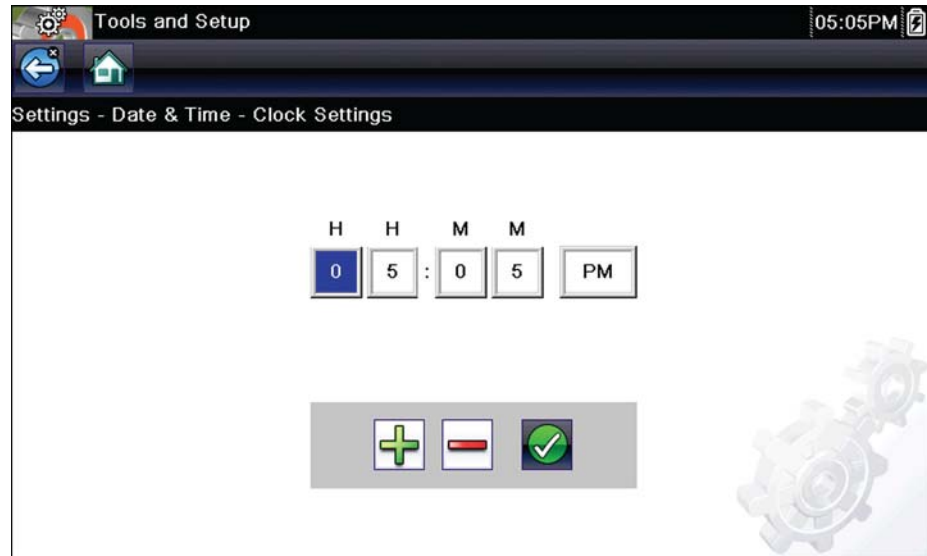

Figure 8-8 Sample Clock Settings screen

4. Tap the **up (+)** button on the screen or press the **up (▲)** key on the keypad to incrementally increase the number in the highlighted field. Tap the **down (-)** button on the screen or press down (▼) on the keypad to incrementally decrease the number.
5. Tap the **check (✓)** button on the screen or press the **Y/✓** key on the keypad to move the highlight to the next field.
6. Repeat Step 4 and Step 5 until the correct time is displayed.
7. Tap the **Back** on the toolbar or press the **Y/✓** on the keypad to close the Clock Settings window and return to the Settings menu.

### ***Daylight Savings Time***

This option opens a menu to configure the internal clock for Daylight Savings Time. Choose from:

- **ON**—sets the clock for Daylight Savings time.
- **OFF**—sets the clock for standard time.

Make either selection, then tap the **Back** button or press the **N/X** key to return to the menu.

### ***Time Format***

This option determines whether time is displayed on a 12 or 24 hour clock. Selecting opens a menu with two choices:

- **24 Hour Format**
- **12 Hour Format**

Make either selection, then tap the **Back** button or press the **N/X** key to return to the menu.

### Date Format

This option allows you to select how date information is displayed. Select from:

- **(MM\_DD\_YYYY)**—Month, Day, Year
- **(DD\_MM\_YYYY)**—Day, Month, Year
- **(YYYY\_MM\_DD)**—Year, Month, Day

Make a selection, then tap the **Back** button or press the **N/X** key to return to the menu.

### Configure Scanner

This option determines whether or not the scales are displayed on the data graphs when using the Scanner. Scales are the graduations and values that display on the horizontal axis at the base of the parameter graphs. The waveform to fill the entire graph area with scales switched off.



Figure 8-9 Sample scanner screen with scales hidden



#### To switch scanner scales:

1. Select **Tools** from the Home screen.
2. Select **Settings** from the Tools and Setup menu.
3. Select **Configure Scanner** from the Settings menu.
4. Highlight either menu entry to make a selection:
  - **Show Graph Scale**—to switch the scales on.
  - **Hide Graph Scale**—to switch the scales off.
5. Tap the **Back** button or press the **N/X** key to return to the Settings menu.

## Configure Units

Selecting opens a dialog box that allows you to choose between US customary or metric units of measure for temperature, vehicle speed, air pressure, and other pressures.

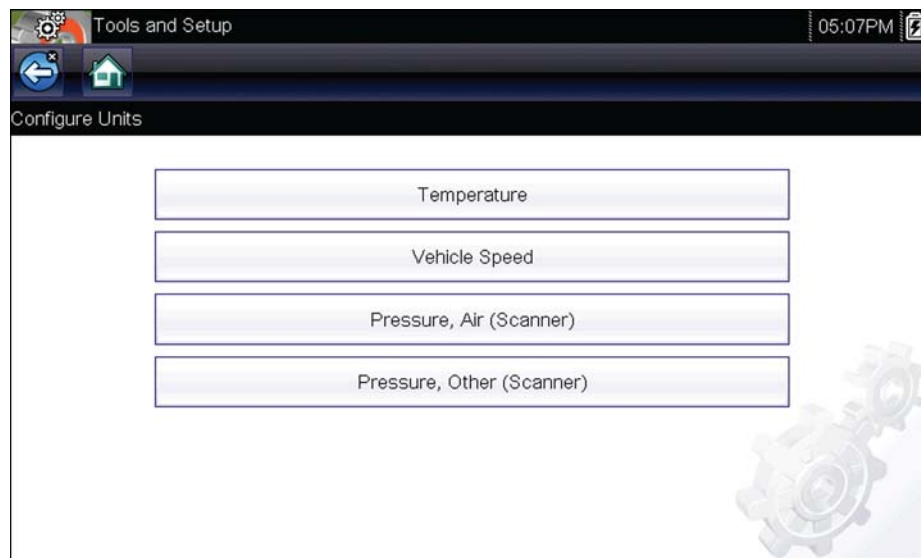

Figure 8-10 Sample Configure Units menu



### To change the units setup:

1. Select **Tools** from the Home screen to open the menu.
2. Select **Configure Units** to open the menu.
3. Select an item from the Configure Units menu.
  - Temperature
  - Vehicle Speed
  - Pressure, Air (Scanner)
  - Pressure, Other (Scanner)
4. Select a setting from the listed choices.
5. Select **Back** on the toolbar or press the **N/X** key to return to the options menu.

This chapter covers how to care for your scan tool.

## 9.1 Cleaning and Inspecting the Scan Tool

When using the scan tool perform the following tasks to keep it in top shape:

- Check the housing, wiring, and connectors for dirt and damage before and after each use.
- At the end of each work day, wipe the scan tool housing, wiring, and connectors clean with a damp cloth.

---

**IMPORTANT:**

Do not use any abrasive cleansers or automotive chemicals on the unit.

---

### 9.1.1 Cleaning the Touch Screen

The touch screen can be cleaned with a soft cloth and a mild window cleaner.

---

**IMPORTANT:**

Do not use any abrasive cleansers or automotive chemicals on the touch screen.

---

## 9.2 Battery Service

Follow all safety guidelines when handling the battery pack.

**⚠ WARNING**

Risk of electric shock.

- **Prior to recycling the battery pack, protect exposed terminals with heavy insulating tape to prevent shorting.**
- **Disconnect all test leads and turn diagnostic tools off before removing the battery pack.**
- **Do not attempt to disassemble the battery pack or remove any component projecting from or protecting the battery terminals.**
- **Do not expose the unit or battery pack to rain, snow, or wet conditions.**
- **Do not short circuit the battery terminals.**

*Electric shock can cause injury.*

**⚠ WARNING**

Risk of explosion.

- **Use the proper factory lithium battery pack only, incorrect replacement or tampering with the battery pack may cause an explosion.**

*Explosion can cause death or serious injury.*

## 9.2.1 Battery Safety Guidelines

---

**IMPORTANT:**

The battery pack contains no user serviceable components. Tampering with the battery pack terminals or housing will void the product warranty.

---

Keep the following in mind when using and handling the battery pack:

- Do not short circuit battery terminals.
- Do not immerse the scan tool or battery pack in water, or allow water to enter the unit or battery compartment.
- Do not crush, disassemble, or tamper with the battery pack.
- Do not heat the battery pack to over 100°C (212°F), or dispose of it in a fire.
- Do not expose the battery pack to excessive physical shock or vibration.
- Keep the battery pack out of reach of children.
- Do not use a battery pack that appears to have suffered abuse or damage.
- Store the battery pack in a cool, dry, well ventilated area.

---

**NOTE:**

The battery pack should be used within a short period of time (about 30 days) after charging to prevent loss of capacity due to self-discharging.

---

If long-term storage of the battery pack is necessary, it should be stored in a cool, dry, well ventilated place with a 30 to 75 percent state of charge to prevent loss of characteristics.

To prolong the life of your battery, power off the unit when not in use. The scan tool has a built in charger that recharges the battery on demand whenever it is connected to a power source.

## 9.2.2 Replacing the Battery Pack

If the battery pack no longer holds a charge, contact your sales representative to order a new one.

---

**IMPORTANT:**

Replace the battery pack with original Snap-on replacement parts only.

---

**To replace the battery pack:**

1. Loosen the two captive screws that secure the battery pack to the back of the unit.
2. Lift up and tilt to raise the battery cover from the scan tool housing.
3. Slide the battery pack to the left to disconnect the contacts, then lift it clear of the unit.
4. Position the new battery pack and slide it into position in the battery compartment.
5. Make sure the battery pack is fully seated.
6. Fit the battery cover.
7. Tighten the two captive screws.

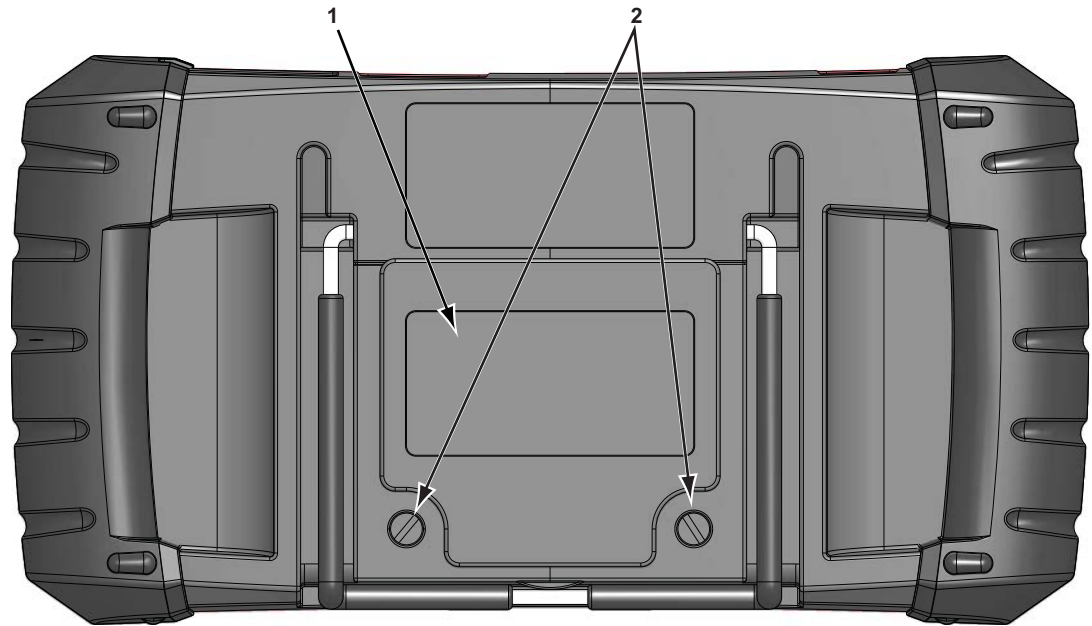

- 1— Battery Cover  
2— Captive Screws

Figure 9-1 Battery pack replacement

### 9.2.3 Disposing of the Batteries

Always dispose of a lithium-ion battery pack according to local regulations, which vary for different countries and regions. The battery pack, while non-hazardous waste, does contain recyclable materials. If shipping is required, ship the battery pack to a recycling facility in accordance with local, national, and international regulations. For additional information contact:

- United Kingdom—Electrical Waste Recycling Company at <http://www.electricalwaste.com>
- Products bearing the WEEE logo (Figure 9-2) are subject to European Union regulations.



Figure 9-2 sample WEEE logo



**NOTE:**

Always dispose of materials according to local regulations.

Contact your sales representative for details.

This chapter includes a brief introduction to some of the key features of the ShopStream Connect software. For detailed ShopStream Connect information and instructions, download the ShopStream Connect User Manual from our website:

<https://www.snapon.com/diagnostics/uk/User-Manuals.htm>

The ShopStream Connect™ (SSC) software is PC-based software that extends the capabilities of your diagnostic tool. Using ShopStream Connect software with your diagnostic tool allows you to do the following:

- View, Print, and Manage data saved from your Diagnostic tool.
- Move and copy your data between the diagnostic tool and your PC.
- View and Print trouble codes saved with select diagnostic tools. This allows you to share the data in a report format with vehicle owners or other technicians.
- Add or edit notes and comments to diagnostic tool data files.
- Download and install diagnostic tool software updates and upgrades.

The ShopStream Connect (SSC) software is available (free of charge) at:

**ShopStream Connect -**

<https://www.snapon.com/diagnostics/UK/Diagnostics/ShopStreamConnect.htm>

## 10.1 Using SSC (Connecting to your PC)



**To connect and use SSC with your diagnostic tool:**

1. Download and install SSC on your PC from:  
<https://www.snapon.com/diagnostics/UK/Diagnostics/ShopStreamConnect.htm>
2. Turn your diagnostic tool on.
3. Connect the supplied USB cable from the USB jack on your diagnostic tool to your PC:
4. From the diagnostic tool Home screen, select **Tools > Connect-to-PC**.

The “**Device is now in Connect-to-PC mode**” screen message is displayed (Figure 10-1) and the ShopStream Connect software will open automatically on your PC (Figure 10-2).

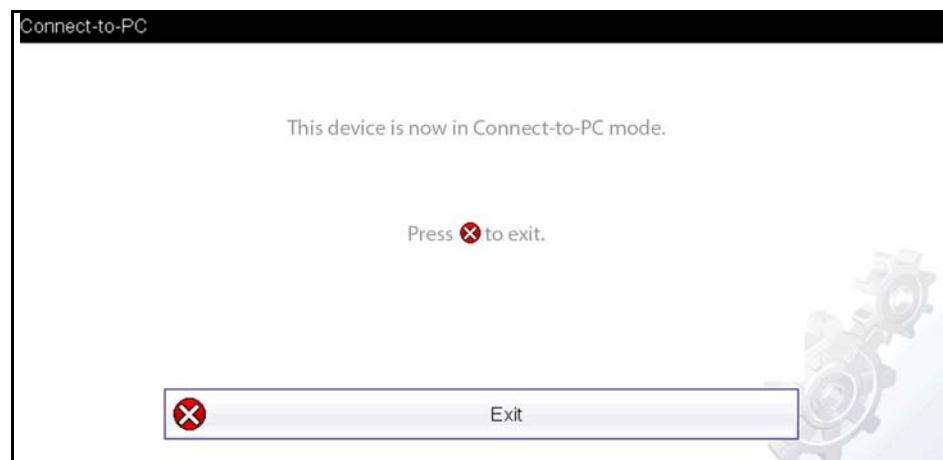

Figure 10-1

If the ShopStream Connect software does not open, open it from the Windows Start menu or use the ShopStream Connect shortcut icon on the Windows desktop (automatically created during installation).

## 10.2 SSC Main Screen

The ShopStream Connect software will open automatically when you connect the diagnostic tool to your PC USB connection, [Using SSC \(Connecting to your PC\)](#), on page 66,.

The following shows the main screen layout for ShopStream Connect software.

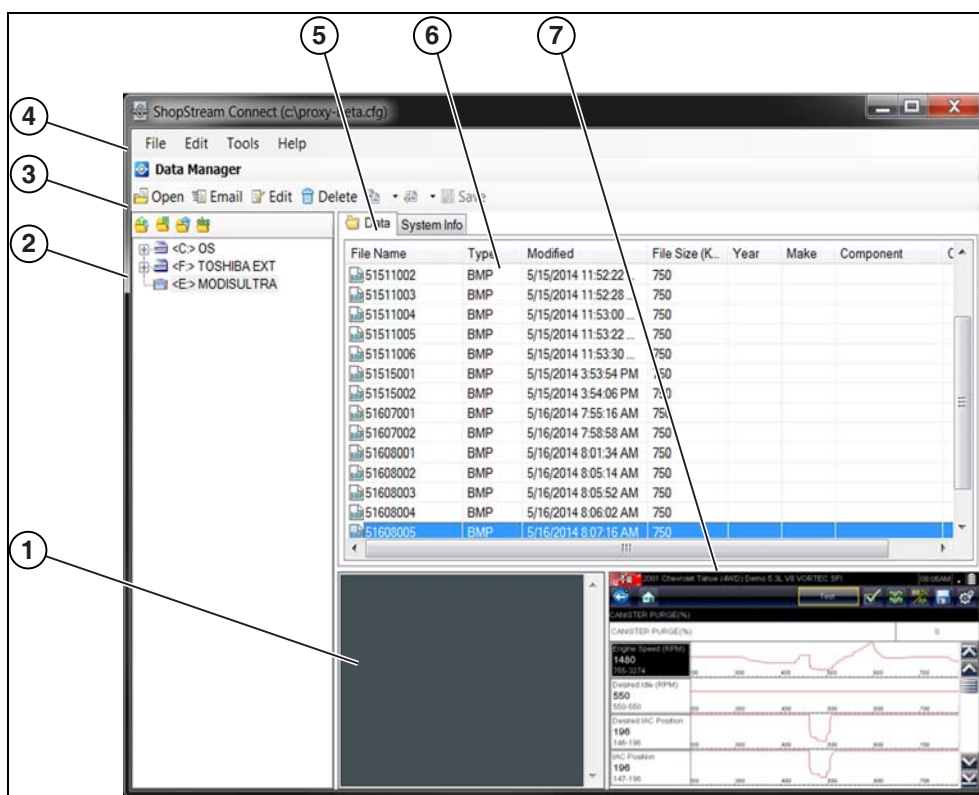

Figure 10-2

- 1— **Notes Window**—allows you add notes to select data files. Select Save from the menu bar to save your notes. *NOTE: Not all file types allow notes, the Notes window will be grayed out when a file type that does not support notes is highlighted. Some image files may display notes for reference purposes (the notes are grayed out and not editable).*
- 2— **File directory structure**—displays the file directory structure of your PC in standard Windows format, and shows any connected diagnostic tools at the bottom of the data list.
- 3— **Data Manager Toolbar**—provides control icons that perform a variety of operations on data files.
- 4— **Main Menu bar**—contains **File**, **Edit**, **Tools**, and **Help** menus.
- 5— **Tabs**—provides access to data files and presets stored on the diagnostic tool or on the PC, and also allows viewing of software revision details of the diagnostic tool.



- 6— **Main display**—shows stored data files details. *NOTE: The files listed are sortable (ascending/descending) by clicking on the column tab at the top (e.g. File Name, Type, etc.) Sort preferences are saved when the ShopStream Connect program is closed.*
- 7— **Preview**—displays a sample of the file if the selected file is a image file.

### 10.3 Scanner DataViewer

SSC allows you to view data files recorded with your diagnostic tool, on your PC. When a Scanner data file is selected, it opens and displays in the Scanner DataViewer (Figure 10-3). Scanner DataViewer allows you play the data file and custom configure the data in a number of ways.



- 1— Menu bar
- 2— Display toolbar
- 3— Graph display
- 4— Properties icon
- 5— Vertical Scroll bar
- 6— Zoom controls
- 7— Slider bar
- 8— Navigation toolbar
- 9— Parameter text list
- 10— Highlighted PIDs - indicates graphs currently displayed
- 11— Parameter configuration tabs

Figure 10-3

## 10.4 Image Viewer

SSC allows you to view and print .bmp, .jpg and .sps image files (screenshots) saved on your diagnostic tool, with your PC.

**NOTE:**

File extension types vary depending on the diagnostic tool. Not all the file extensions described here may be available on your diagnostic tool.



**1— Exit** - closes the Image Viewer  
**2— Print** - prints the image

**3— Print Preview** - allows the image to be previewed before printing  
**4— Captured Screen Image**

Figure 10-4

# 10.5 Printing the Code Scan Report

To print the Code Scan Report, the saved code scan .XML file must be opened using ShopStream Connect.

**To print the Code Scan Report using ShopStream Connect:**

1. Double-click the code scan .XML file from the file list to open the report (Figure 10-5) in the Code Scan Viewer (Figure 10-6).

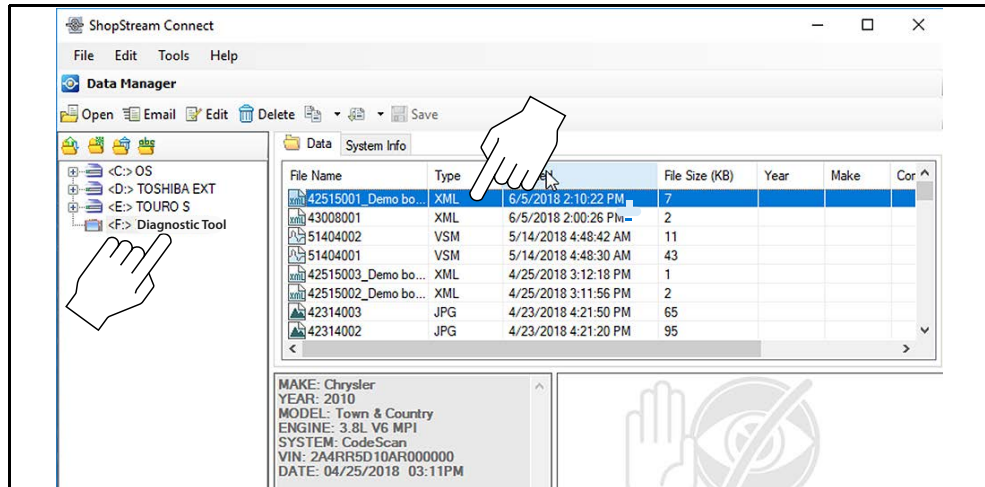

Figure 10-5

2. Select **Print** or **Print Preview** from the Code Scan Viewer menu to print or preview the report (Figure 10-6).

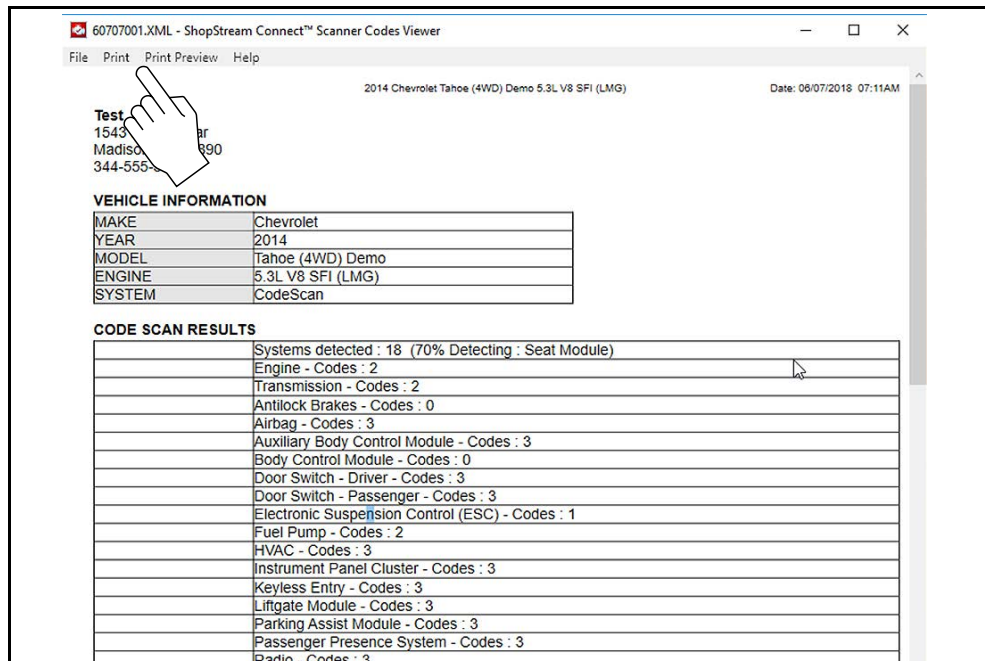

Figure 10-6

Selecting **Print** opens the Windows print dialog window (Figure 10-7). Select your printer from the list, then select **Print** to print the report.

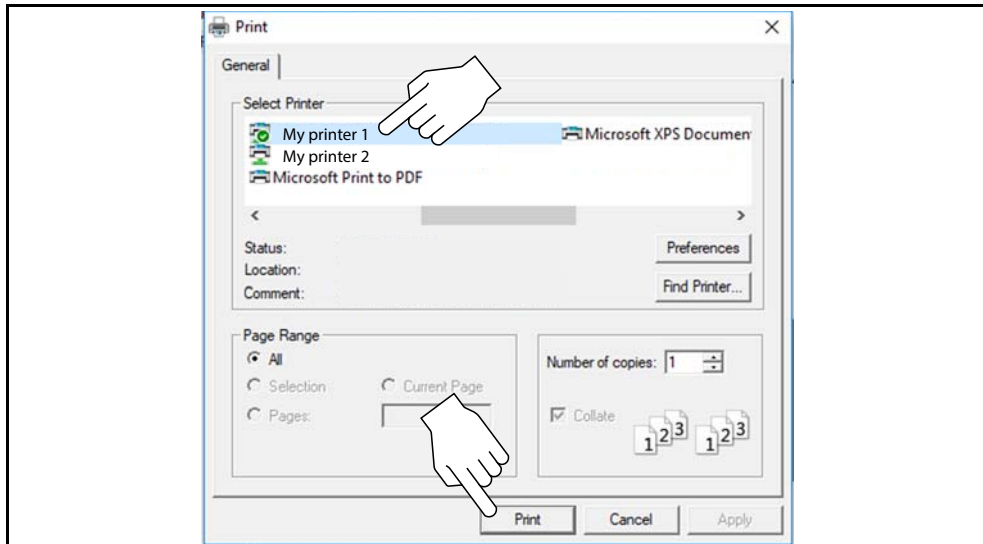

Figure 10-7

## 10.6 Software Upgrades and Updates

Upgrade/Update Descriptions:

- **Software Upgrade** - a software upgrade is a new software version (contact your sales representative for purchase information).
- **Software Update** - a software update is a service release for installed software. These are available free of charge, and are provided as necessary to update installed software. When your diagnostic tool is connected to a PC using SSC, the SSC software will automatically check for updates, and if an update is available, it will provide installation instructions. Follow the screen prompts to accept, download and install the software.



**NOTE:**

To receive updates or upgrades, SSC software must be installed on your PC and have connection to the Internet.



**Example - Updating diagnostic tool software:**

1. Select **Tools > Update Software > (diagnostic tool type - e.g. ETHOS Edge, MODIS Edge, SOLUS Edge, etc.)** from the Menu bar (Figure 10-8).

The software checks the Snap-on web server for available updates.

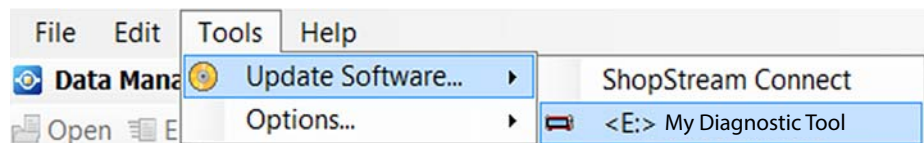

Figure 10-8

2. If service release updates are available, select **Next** to continue, then select **Download** and follow the on-screen instructions to complete the installation (Figure 10-9).

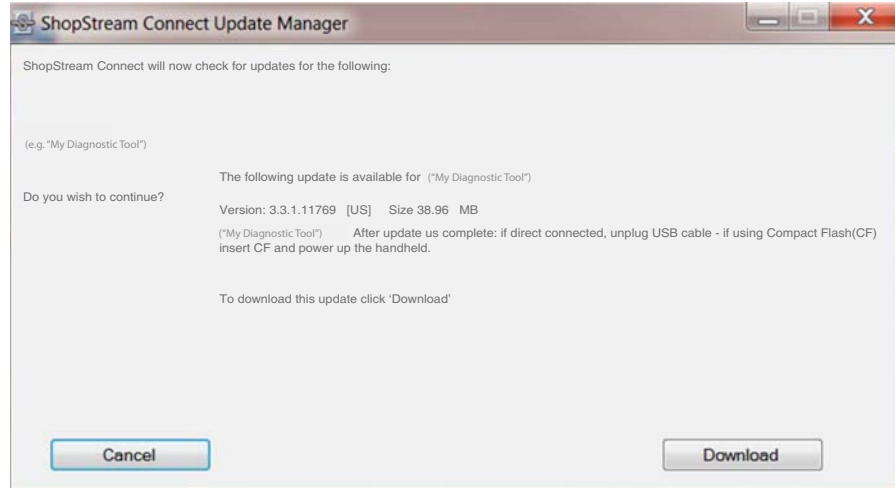

Figure 10-9



**NOTE:**

For additional information on ShopStream Connect software updates and upgrades, download the ShopStream Connect User Manual from our website:

<https://www.snapon.com/diagnostics/uk/User-Manuals.htm>

### 10.6.1 End User License Agreement

Before software installation at initial purchase, and before all subsequent software updates/ upgrades installations End User License Agreement (EULA) acceptance is required.

**IMPORTANT:**

Use of Software is governed by the terms and conditions of the End User License Agreement. The diagnostic tool should not be initially operated until the End User License Agreement is read. Use of the device acknowledges your acceptance of the End User License Agreement. The Snap-on Incorporated Software End User License Agreement is available at: <https://eula.snapon.com/diagnostics>

**To Accept:** at the screen prompt (Figure 10-10) click the checkbox on the left side of the window, and then select **Agree and Continue**. The software will be installed automatically.

Figure 10-10 below represents a typical EULA acceptance agreement screen.

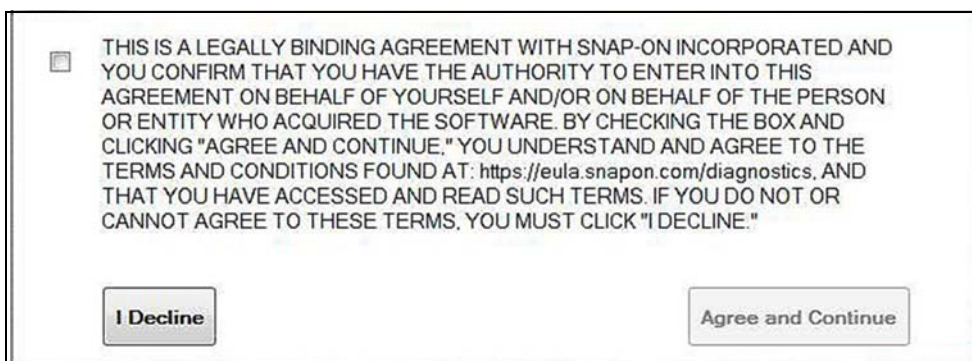

Figure 10-10 Typical EULA acceptance screen

**To Decline:** at the screen prompt (Figure 10-10) select **I Decline**. A confirmation message is displayed providing options to Go Back or Exit the software installation (Figure 10-11).

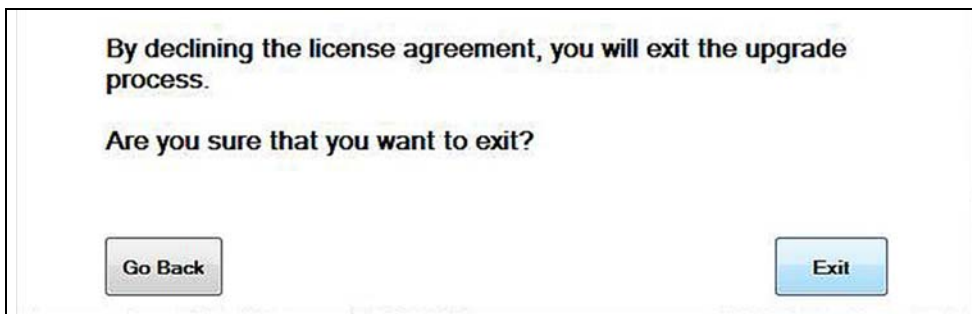

Figure 10-11 Typical EULA acceptance screen