

# SOLUS Ultra™

## User Manual



---

# Legal Information

## Trademarks

Snap-on is a trademark, registered in the United States and other countries, of Snap-on Incorporated. This publication contains many Snap-on Incorporated trademarks, including but not limited to Snap-on, and ShopStream. All other marks are trademarks or registered trademarks of their respective holders.

## Copyright Information

© 2018 Snap-on Incorporated. All rights reserved.

## Disclaimer of Warranties and Limitation of Liabilities

All pictures and illustrations shown are for reference purposes only. All information, specifications and illustrations in this manual are based on the latest information available at the time of printing and are subject to change without notice. While the authors have taken due care in the preparation of this manual, nothing contained herein:

- Modifies or alters in any way the standard terms and conditions of the purchase, lease, or rental agreement under the terms of which the equipment to which this manual relates was acquired.
- Increases in any way the liability to the customer or to third parties.

Snap-on<sup>®</sup> reserves the right to make changes at any time without notice.

---

### IMPORTANT:

Before operating or maintaining this unit, please read this manual carefully paying extra attention to the safety warnings and precautions.

---

## Software License Information

Use of Software is governed by the terms and conditions of the End User License Agreement. The diagnostic tool should not be initially operated until the End User License Agreement is read. Use of the device acknowledges your acceptance of the End User License Agreement. The Snap-on Incorporated Software End User License Agreement may be provided with the diagnostic tool, and is available at: <https://eula.snapon.com/diagnostics>.

## Patent Information

For a listing of Snap-on products that are protected by patents in the United States and elsewhere, visit: <https://patents.snapon.com>

## User Manual Information

This manual includes information and images applicable with diagnostic software version 18.4 and later. Some information within this manual may not be applicable with other diagnostic software versions.

The information in this manual is periodically revised to ensure the latest information is included. The current version of this manual and other technical documentation is available online from Snap-on Diagnostics.

# Product Support Information

## Phone / E-mail - Technical Assistance

1-800-424-7226 / [diagnostics\\_support@snapon.com](mailto:diagnostics_support@snapon.com)

or use our online contact form

- <https://www1.snapon.com/diagnostics/us/Contact>

## Website Links:

### Snap-on Diagnostics and Information

- <http://diagnostics.snapon.com>

**Manuals / Technical Documentation** - This manual is periodically revised to ensure the latest information is included. Download the latest version of this manual and other related technical documentation at:

- <http://diagnostics.snapon.com/usermanuals>

For technical assistance in all other markets, contact your selling agent.

## Product Training Videos

Diagnostic tool specific training videos are available on our website. Follow along and learn the basics of diagnostic tool operation with our free training videos.

Videos are product specific and are available at:

<http://diagnostics.snapon.com> - Click on the "Training & Support" tab, select the applicable diagnostic tool, then select "See Training".



### NOTE:

Sample titles are listed below. Not all titles may be available for all diagnostic tools, and are subject to change.

Snap-on® Training Solutions® - Training Videos (examples)	
Introduction and Navigation	Global OBD-II
Scanner Codes	Digital Multimeter
Scanner Data in PID View	Graphing Multimeter & Lab Scope
Scanner Data in Graphing View	Guided Component Tests
Fast-Track® Troubleshooter	Vehicle Specs & Resets
Functional Tests	SureTrack® & Wi-Fi

## Diagnostic Quick Tips - Video Series

Snap-on Diagnostic Quick Tips videos are available at no charge on our website and on our YouTube channel. These videos are developed from real repair case studies to help professional technicians use diagnostic tools to solve specific vehicle problems (e.g. performing a Ford Relative Injector Flow Test).

Additional videos are also available showing specific diagnostic tool features (e.g. ShopStream Connect - Software Updates).



Figure 1-1

Videos are available at:

<http://diagnostics.snapon.com> - Click on the “Training & Support” tab, select the applicable diagnostic tool, then select “See Quick Tips”

<https://www.youtube.com/user/snaponscanner/videos> - Use the search function to find a title, or enter “Diagnostic Quick Tips” in the search field to see a list of all applicable titles.



**NOTE:**

URL links (above) and titles listed (below) are subject to change and may not be available in all markets.

A sample list of titles are listed below, other titles may be available.

Some videos may not be applicable for use with all diagnostic tools.

Snap-on® Training Solutions® - Diagnostic Quick Tips Videos (examples)	
Air/Fuel Ratio Sensor Test	Fuel Injector Voltage and Current Tests (Scope)
Alternator Ripple Test (Scope)	Fuel Pump Current Ramp Test (Scope)
BMW® Rain Sensor Calibration	Harley-Davidson® ABS Brake Bleed
CAN Bus Diagnostics (Scope)	Harley-Davidson® Functional Tests
Chevrolet® Volt Coolant Pump Bleed	Harley-Davidson® Key Fob Programming

<b>Snap-on® Training Solutions® - Diagnostic Quick Tips Videos (examples)</b>	
Chrysler HVAC Test	Hyundai Blind Spot Detection System Calibration
Chrysler VVT System Cleaning	Hyundai Occupant Detection System Reset
Chrysler Wheel & Tire Calibrations	Ignition Coil Current and Voltage Comparison
COP Ignition Test	Ignition Coil Current Ramp Test
Dual Screen Diagnostics: Scanner vs. Scope	Ignition Coil Primary Voltage Test
Electronic Throttle Control System Diagnostics	Ignition System Diagnostics Using the SIA2000 (Scope)
FIAT® 500 Proxi Alignment	MINI Battery Relearn
FIAT® 500 Throttle Body Relearn	Multi Channel Cam / Crank Correlation
Flex Ray Bus Diagnostics	OBD-II Mode 10 Permanent Codes
Ford Battery Monitor System	Oil Specs & Service Light Resets
Ford Coil Current RFI Test (Scope)	PID Trigger Functions (Scanner)
Ford Flash Reprogramming	Piezo Injectors Signature Test
Ford Misfire Monitor Neutral Profile Correction (Scanner)	Relative Compression Test (Scope)
Ford PATS Key Programming	ShopStream Connect - Data Manipulation
Ford Relative Compression Test	ShopStream Connect - Software Updates
Ford Relative Injector Flow Test	Speed Up Your Diagnostics (Scanner)
Ford TPMS Reprogramming	The Power of Troubleshooter Tips (Scanner)
Ford® 6.7L Transmission Solenoid Characterization	Top Level Menus: Built In Scope Training
Ford® Diesel Injector Coding	Toyota EVAP Test
VW / Audi Flexible Service Reset (Scanner)	Toyota Multiple Freeze Frame (Scanner)
	Toyota Transmission Compensation Coding

# Contents

<b>Chapter 1: Using This Manual .....</b>	<b>5</b>
Content .....	5
Conventions .....	5
Terminology .....	5
Symbols .....	5
Bold Text .....	6
Notes and Important Messages .....	6
Hyperlinks .....	6
Procedures .....	6
<b>Chapter 2: Introduction .....</b>	<b>7</b>
Control Buttons .....	7
Data and Power Connections .....	8
Battery Pack and Stand .....	9
Power Sources .....	9
Internal Battery Pack .....	10
AC Power Supply .....	10
Vehicle Power .....	10
Technical Specifications .....	11
<b>Chapter 3: Basic Operation and Navigation .....</b>	<b>12</b>
Turning On/Off and Emergency Shutdown .....	12
Turning On .....	12
Turning Off .....	12
Emergency Shutdown .....	13
Basic Navigation .....	13
Home Screen Layout .....	13
Title Bar .....	14
Home Screen Icons .....	15
Common Toolbar Control Icons .....	16
Scroll Bar .....	17
Screen Messages .....	18
System Messages .....	18
Communication Messages .....	18
Data Cable Connection .....	19
<b>Chapter 4: Scanner .....</b>	<b>20</b>
Screen Layout and Toolbar Icons .....	20
Screen Layout .....	20
Scanner Control Icons .....	21
Scanner Demonstration Program .....	21
Scanner Operation .....	22
Vehicle Identification .....	22
Connecting the Data Cable .....	23
System and Test Selection .....	24

---

Exiting Scanner .....	41
<b>Chapter 5: OBD-II/EOBD .....</b>	<b>42</b>
Basic Operations .....	42
Screen Layout and Toolbar Controls .....	42
Connecting the Data Cable .....	42
Saving and Reviewing Data Files .....	42
OBD-II/EOBD Menu .....	42
OBD Health Check .....	43
OBD Direct .....	45
<b>Chapter 6: Previous Vehicles and Data .....</b>	<b>52</b>
Previous Vehicles and Data Menu .....	52
Vehicle History .....	52
View Saved Data .....	53
Delete Saved Data .....	55
<b>Chapter 7: Tools .....</b>	<b>56</b>
Tools Menu .....	56
Connect to PC .....	57
Configure Shortcut Button .....	57
System Information .....	58
Settings .....	58
<b>Chapter 8: Maintenance .....</b>	<b>66</b>
Cleaning and Inspecting the Diagnostic Tool .....	66
Cleaning the Touch Screen .....	66
Battery Service .....	66
Battery Safety Guidelines .....	67
Replacing the Battery Pack .....	67
Disposing of the Batteries .....	68
<b>Chapter 9: ShopStream Connect .....</b>	<b>69</b>
Using SSC (Connecting to your PC) .....	69
SSC Main Screen .....	70
Scanner DataViewer .....	71
Image Viewer .....	72
Printing the Code Scan Report .....	73
Software Upgrades and Updates .....	75
End User License Agreement .....	76
<b>Chapter 10: SureTrack Community .....</b>	<b>77</b>
SureTrack - Online Community .....	77
Main Topic Links .....	77
Quick Reference .....	77
Finding your SureTrack Authorization Code .....	78
Creating a SureTrack Account .....	79
Logging In (active account) .....	83
Logging In with New Authorization Code (active account) .....	84
Logging In with New Authorization Code (expired account) .....	85
SureTrack Features .....	87
SureTrack Screens .....	88

---

# Safety Information

## READ ALL INSTRUCTIONS

For your own safety, the safety of others, and to prevent damage to the product and vehicles upon which it is used, it is important that all instructions and safety messages in this manual and the accompanying *Important Safety Instructions* manual be read and understood by all persons operating, or coming into contact with the product, before operating. We suggest you store a copy of each manual near the product in sight of the operator.

For your safety, read all instructions. Use your diagnostic tools only as described in the tool user's manual. Use only manufacturer recommended parts and accessories with your diagnostic tools.

This product is intended for use by properly trained and skilled professional automotive technicians. The safety messages presented throughout this manual and the accompanying *Important Safety Instructions* manual are reminders to the operator to exercise extreme care when using this product.

There are many variations in procedures, techniques, tools, and parts for servicing vehicles, as well as in the skill of the individual doing the work. Because of the vast number of test applications and variations in the products that can be tested with this instrument, we cannot possibly anticipate or provide advice or safety messages to cover every situation. It is the responsibility of the automotive technician to be knowledgeable of the system being tested. It is essential to use proper service methods and test procedures. It is important to perform tests in an appropriate and acceptable manner that does not endanger your safety, the safety of others in the work area, the equipment being used, or the vehicle being tested.

It is assumed that the operator has a thorough understanding of vehicle systems before using this product. Understanding of these system principles and operating theories is necessary for competent, safe and accurate use of this instrument.

Before using the equipment, always refer to and follow the safety messages and applicable test procedures provided by the manufacturer of the vehicle or equipment being tested. Use the product only as described in its user manual. Use only manufacturer recommended parts and accessories with your product.

Read, understand and follow all safety messages and instructions in this manual, the accompanying *Important Safety Instructions* manual, and on the test equipment.

### **Environmental Conditions:**

- This product is intended for indoor use only
- This product is rated for Pollution Degree 2 (normal conditions)



## Safety Signal Words

All safety messages contain a safety signal word that indicates the level of the hazard. An icon, when present, gives a graphical description of the hazard. Safety Signal words are.

### **DANGER**

Indicates an imminently hazardous situation which, if not avoided, will result in death or serious injury to the operator or to bystanders.

### **WARNING**

Indicates a potentially hazardous situation which, if not avoided, could result in death or serious injury to the operator or to bystanders.

### **CAUTION**

Indicates a potentially hazardous situation which, if not avoided, may result in moderate or minor injury to the operator or to bystanders.

## Safety Message Conventions

Safety messages are provided to help prevent personal injury and equipment damage. Safety messages communicate the hazard, hazard avoidance and possible consequences using three different type styles:

- Normal type states the hazard.
- **Bold type states how to avoid the hazard.**
- *Italic type states the possible consequences of not avoiding the hazard.*

An icon, when present, gives a graphical description of the potential hazard.

## Safety Message Example

### **WARNING**



Risk of unexpected vehicle movement.

- **Block drive wheels before performing a test with engine running.**

*A moving vehicle can cause injury.*

## Important Safety Instructions

For a complete list of safety messages, refer to the accompanying *Important Safety Instructions manual*.

**SAVE THESE INSTRUCTIONS**

## 1.1 Content

This manual contains basic operating instructions and is structured in a manner to help you become familiar with your Diagnostic Tool features and perform basic operations.

The illustrations in this manual are intended as reference only and may not depict actual screen results, information, functions or standard equipment. Contact your sales representative for availability of other functions and optional equipment.

## 1.2 Conventions

The following conventions are used.

### 1.2.1 Terminology

The terms “Scanner” and “Scanner function” are used to describe the Scanner Function(s) of the Diagnostic Tool.

Examples:

- Select **Scanner** from the Home screen.
- From the Scanner main menu select **Continue**.
- The Scanner function provides many diagnostic tests.

The term “select” describes tapping/touching an icon on the touch screen, or highlighting an icon or menu choice and then selecting the confirmation menu choice such as **Continue, Accept, OK, Yes, or other similar** choice.

Abbreviated example for the following procedure: “Select **Brightness**”

1. Navigate to and highlight the **Brightness** selection.
2. Select **OK, or similar**, button.

### 1.2.2 Symbols

Different types of arrows are used. The “greater than” arrow (>) indicates an abbreviated set of selection (navigation) instructions.

Abbreviated example for the following procedure: “Select **Tools > Connect-to-PC**”

1. Select **Tools** from the home screen.
2. Highlight **Connect-to-PC** on the Tools menu.
3. Select **Connect-to-PC**.

The solid arrows (◀, ▶, ▼, ▲) are navigational instructions for the four directions of the directional buttons.

Example: Press the down ▼ arrow.

### 1.2.3 Bold Text

Bold emphasis is used in procedures to highlight selectable items such as control buttons, icons and menu options.

Example: Press the **OK** button

### 1.2.4 Notes and Important Messages

The following messages are used.

#### Notes

A NOTE provides helpful information such as additional explanations, tips, and comments.

Example:



#### NOTE:

For additional information refer to...

---

#### Important

IMPORTANT indicates a situation which, if not avoided, may result in damage to the test equipment or vehicle.

Example:

---

#### IMPORTANT:

Do not disconnect the data cable while the Diagnostic Tool is communicating with the ECM.

---

### 1.2.5 Hyperlinks

Hyperlinks, or hot links, that take you to other related articles, procedures, and illustrations are available in electronic documents. Blue colored text indicates a selectable hyperlink.

Example:

---

#### IMPORTANT:

Read all applicable "[Safety Information](#)" before using this Diagnostic Tool!

---

### 1.2.6 Procedures

An arrow icon in the left-margin area indicates a procedure.

Example:



#### To change screen views:

1. Select the **Graph** icon.  
The dropdown menu displays.
2. Select an option from the menu.  
The screen layout changes to the format selected.



The SOLUS Ultra<sup>®</sup> Diagnostic Tool interfaces with the electronic control system of a vehicle to retrieve diagnostic trouble codes (DTCs), access serial data stream information, and command bi-directional tests. Various vehicle control systems, such as engine, transmission, and antilock brake system (ABS), are readily diagnosed using this Diagnostic Tool. The Diagnostic Tool is capable of graphing up to four live data parameters on a single screen, and also includes an extensive database of vehicle-specific troubleshooting information.



This chapter introduces the basic features of the Diagnostic Tool, including the control buttons, data ports, battery pack, and power sources. Technical Specifications are provided at the end of this chapter.

## 2.1 Control Buttons

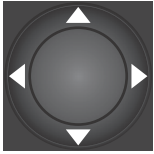

Figure 2-1 Front view

Item	Button	Description	
1		<b>N/X or Cancel</b> - Push type button	<ul style="list-style-type: none"> <li>To exit a menu or program.</li> <li>To close an open list and return to the previous menu or screen.</li> <li>To answer "No" when a yes/no choice is given.</li> </ul>
2		<b>Y/✓ or Accept</b> - Push type button	<ul style="list-style-type: none"> <li>To confirm a selection from a menu or program</li> <li>To select an item that was highlighted using the direction arrows.</li> <li>To advance to the next screen in a series.</li> <li>To answer "Yes" when a yes or no choice is given.</li> </ul>

Item	Button	Description	
3		<b>Directional</b> - Thumb pad rocker type buttons	Buttons move the cursor or highlight in their respective direction: <ul style="list-style-type: none"> <li>• Up (▲)</li> <li>• Down (▼)</li> <li>• Left (◀)</li> <li>• Right (▶)</li> </ul>
4		<b>S (Shortcut)</b> - Push type button	Programmable function button that can provide a shortcut for performing a variety of routine tasks. Refer to <a href="#">Configure Shortcut Button</a> , on page 57 for additional information.
5		<b>Power (On/Off)</b> - Push type button	Turns the Diagnostic Tool on and off. Also, press and hold for 5 seconds for emergency shutdown

## 2.2 Data and Power Connections

Connectors and jacks for the scope multimeter, data communication cables and the AC power supply are located on the top of the Diagnostic Tool.

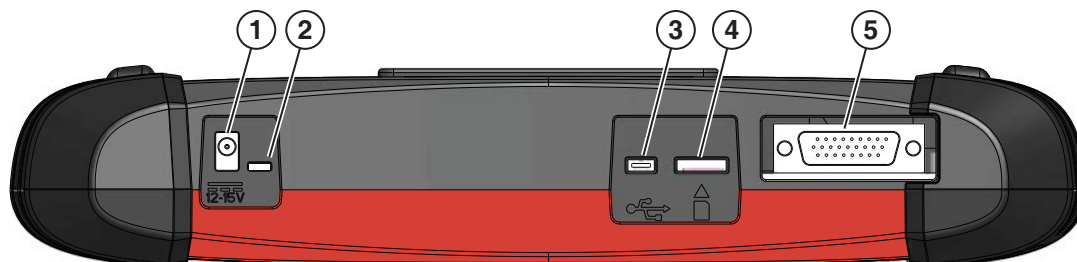

Figure 2-2 Top view

Item	Description
1	<b>DC Power Supply Jack</b> - AC power supply connection
2	<b>Battery Status Indicator LED</b> <ul style="list-style-type: none"> <li>• Green - battery is fully charged</li> <li>• Red - battery is charging</li> <li>• Amber - indicates there is a battery issue (correct before operating)</li> </ul>
3	<b>Mini USB Jack</b> - USB cable connection used to connect the Diagnostic Tool to a personal computer
4	<b>Micro secure digital (uSD) Card</b> - contains operating system programming. <b>IMPORTANT The uSD card must be installed for the Diagnostic Tool to operate. Do not remove the uSD card while the Diagnostic Tool is powered on.</b>
5	<b>Data Cable Connector</b> - Data cable connection used to connect the Diagnostic Tool to a vehicle data link connector

## 2.3 Battery Pack and Stand

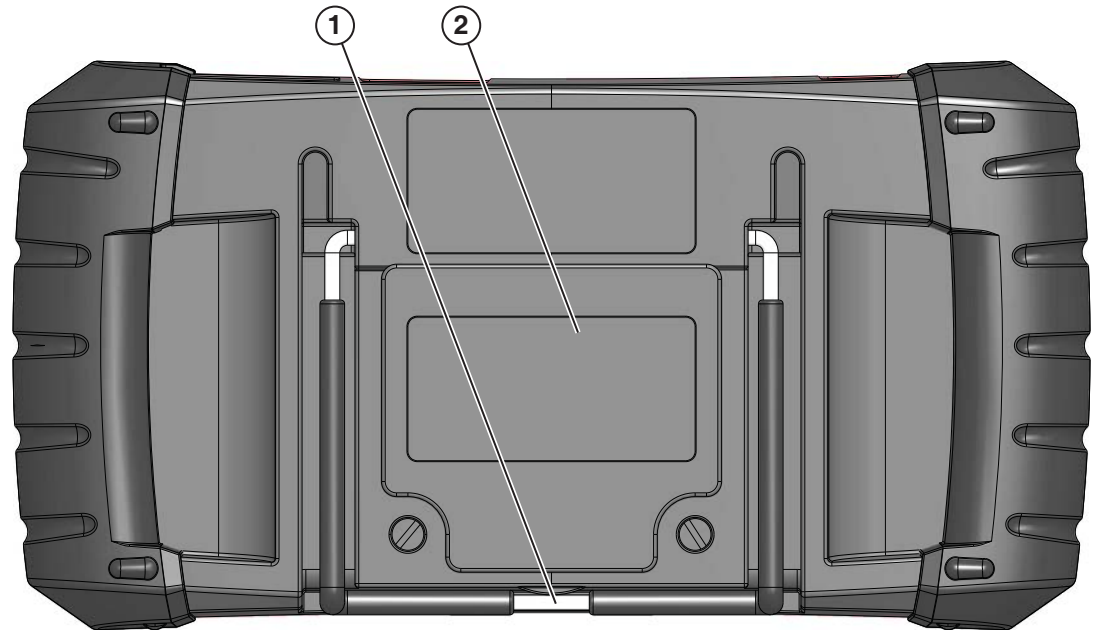

Figure 2-3 Rear view

Item	Description
1	<b>Built in-Stand (shown closed)</b> - The built-in stand extends from the back of the Diagnostic Tool and clips into the Diagnostic Tool for storage.
2	<b>Battery Cover</b>

## 2.4 Power Sources

Your Diagnostic Tool can receive power from any of the following sources:

- [Internal Battery Pack](#)
- [AC Power Supply](#)
- [Vehicle Power](#)

## 2.4.1 Internal Battery Pack

The Diagnostic Tool can be powered from the internal rechargeable battery pack. A fully charged battery provides sufficient power for about 3 hours of continuous operation.

Battery charging occurs when the Diagnostic Tool is connected to the AC Power Supply and to a live AC power source.

The Battery Status Indicator LED (located next to the DC power supply jack) indicates battery status ([Figure 2-3](#)).

- **Green** - indicates battery is fully charged
- **Red** - indicates battery is charging
- **Amber** - indicates a battery issue. This is usually caused by excessive battery temperature (above 104°F/40°C), which disables charging. Allow the Diagnostic Tool to cool down before continuing operation.

## 2.4.2 AC Power Supply

The Diagnostic Tool can be powered from a standard AC outlet using the AC power supply. The connector on the end of the output cable of the AC power supply attaches to the DC power supply input jack on top of the Diagnostic Tool. Use only the AC power supply provided.

---

**IMPORTANT:**

Never connect the AC power supply to the DC power supply input on the Diagnostic Tool when the Diagnostic Tool is communicating with a vehicle.

---

## 2.4.3 Vehicle Power

All OBD-II/EOBD vehicles have vehicle battery power (B+) available on the DLC. The Diagnostic Tool is powered through the Data Cable when connected to the vehicle DLC. A green LED indicator on the DLC end of the data cable, illuminates when power is being supplied to the cable. If the LED fails to illuminate, check that the data cable is properly connected and then check the DLC power circuit. See [Data Cable Connection](#), on page 19 for additional data cable information.

An optional power cable is required when testing non-OBD-II/EOBD models that do not have vehicle battery power (B+) available on the DLC. Contact your sales representative for availability.

---

**IMPORTANT:**

Never connect the optional power cable to the DC power supply input on the Diagnostic Tool when the Diagnostic Tool is communicating with a vehicle.

---

## 2.5 Technical Specifications

Item	Description / Specification
<b>Touch Screen</b>	Resistive Touch Panel
<b>Display</b>	7.0 inch diagonal, Color LCD
	800 x 480 resolution SWVGA
<b>Battery</b>	Rechargeable lithium-ion battery pack
	Approximately 2 hour run time
	Approximately 5 hour charge time
<b>Power Supply</b>	Supply Rating; 15 VDC, 2A
<b>DC Operating Voltage</b>	10 to 30VDC
<b>Width</b>	11.2 in. (285 mm)
<b>Height</b>	5.98 in. (151.8 mm)
<b>Depth</b>	2 in. (50.9 mm)
<b>Weight (including battery):</b>	2.6 lb (1.18 kg)
<b>Operating Temperature Range (ambient)</b>	At 0 to 90% relative humidity (non-condensing) 32 to 113°F (0 to 45°C)
<b>Storage Temperature (ambient)</b>	At 0 to 70% relative humidity (non-condensing) -4 to 140°F (-20 to 60°C)
<b>Environmental Conditions</b>	This product is intended for indoor use only
	This product is rated for Pollution Degree 2 (normal conditions)



# Basic Operation and Navigation

This chapter describes basic Diagnostic Tool operation, navigation, screen layout, icon functions, and screen messages. Before you operate the Diagnostic Tool, make sure the battery pack is fully charged or the Diagnostic Tool is powered by the AC power supply.

## 3.1 Turning On/Off and Emergency Shutdown

The following sections describe how to turn the Diagnostic Tool on and off and how to perform an emergency shutdown.

### 3.1.1 Turning On

The Diagnostic Tool will automatically turn on and open the Home screen ([Figure 3-1](#)) when power is supplied through the Data Cable or by the AC Power Supply. If the Diagnostic Tool does not automatically turn on, press and release the Power button on the front of the Diagnostic Tool to turn the Diagnostic Tool on.

### 3.1.2 Turning Off

---

**IMPORTANT:**

All vehicle communication must be terminated **BEFORE** turning off the Diagnostic Tool. A warning message displays if you attempt to turn the Diagnostic Tool off while communicating with the vehicle. Forcing a shut down while communicating may lead to ECM problems on some vehicles. Never disconnect the Data Cable when the Diagnostic Tool is communicating with the vehicle ECM.

---

**To turn off the Diagnostic Tool:**

1. Press the **N/X** button or select the **Back** or **Home** icon to navigate to the Home screen.  
The “stopping communication” message appears briefly before the Home screen displays.
2. Disconnect the Diagnostic Tool Data Cable from the vehicle.
3. Press and release the **Power** button.  
A confirmation screen displays.
4. Press the **Y/✓** button or select **OK** from the menu to turn the Diagnostic Tool off. To continue operating, press the **N/X** button or select **Cancel** from the menu.

### 3.1.3 Emergency Shutdown

**IMPORTANT:**

Using the emergency shutdown procedure while communicating with the vehicle ECM may lead to ECM problems on some vehicles.

During normal operation turn the Diagnostic Tool off using the *Turning Off* procedure above. The emergency shutdown procedure should only be used if the Diagnostic Tool does not respond to navigation or control buttons or exhibits erratic operation. To force an emergency shutdown, press and hold the **Power** button for five seconds until the Diagnostic Tool turns off.

## 3.2 Basic Navigation

### 3.2.1 Home Screen Layout

The Home screen includes a title bar and main body. The Home screen contains icons, one for each of the primary Diagnostic Tool functions.

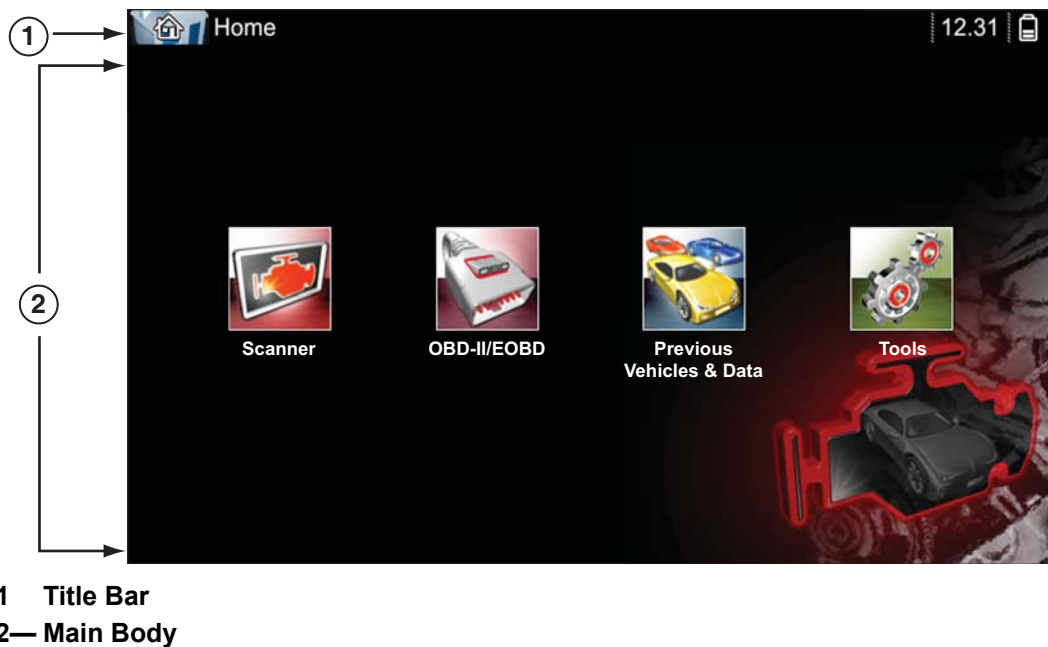

Figure 3-1 Home screen

### 3.2.2 Title Bar

The title bar at the top of the screen provides basic information about current Diagnostic Tool operating conditions. Title bar options vary depending upon vehicle make and model, what function is active, what test is being performed, or what menu is selected. The title bar contains information only, there are no selectable items.

Elements of the Title bar let you know at a glance:

- What Diagnostic Tool function is currently active.
- The current time.
- The source and status of the power being supplied to the Diagnostic Tool.





An active function icon is always displayed along the left-hand edge of the Title bar. These icons resemble their Home screen icon counterparts in appearance and color. The name of the function displays to the right of the icon on some screens.

A real time clock displays to the left of the power supply icon. The clock is powered by a dedicated internal battery, so the correct time is maintained even when the main battery pack is discharged. Use the Tools function to set the clock and format how time is displayed. See ["Clock Settings," on page 62](#) for additional information.

The Title bar displays other information that varies depending upon what functions are being performed. Other information may include:

- The identification (ID) of the test vehicle
- The name of the active menu or function
- The name of the test being performed

**Table 3-1** Title Bar Icons





Icon	Function	Icon	Function
	<b>Full Battery Charge Level</b> - Indicates power is being supplied by the internal battery pack. Horizontal bars diminish as the battery discharges.		<b>External Power Connected</b> - Indicates power is being supplied through the data cable connection to a vehicle or by the AC Power Supply.
	<b>Low Battery Charge Level</b> - Indicates the internal battery pack is low and needs to be recharged immediately. A warning message will also display on the screen when the battery gets low.		<b>Active Vehicle Communication</b> - Indicates the Diagnostic Tool is actively communicating with a vehicle.

### 3.2.3 Home Screen Icons

Each available Diagnostic Tool function is represented by an icon on the home screen. The table below provides descriptions of the icon functions.









Select an icon from the Home screen to start a function. You can also use the control buttons to activate a function, a yellow border around the icon indicates it is highlighted, or in focus. Use the Directional buttons (◀, ▶, ▲, ▼) to highlight the desired function and then press the Y/✓ button to select it. A “please wait” message may display briefly, then automatically clear once the function is loaded and ready for use.

**Table 3-2** Home screen icons

Function Name	Function Icon	Description
Scanner		Used to communicate with the electronic control systems of a vehicle. This function allows you to retrieve diagnostic trouble codes (DTCs), view PID data and perform diagnostic tests. See "Scanner," on page 20 for details.
OBD-II/EOBD		Allows you to access generic OBD-II/EOBD data and tests without identifying the vehicle being tested. See "OBD-II/EOBD," on page 42 for details.
Previous Vehicle & Data		Allows you to quickly reconfigure the Diagnostic Tool to a recently tested vehicle and to access saved data files. See "Previous Vehicles and Data," on page 52 for details.
Tools		Allows you to adjust Diagnostic Tool settings to your personal preferences and perform other special functions. See "Tools," on page 56 for details.

### 3.2.4 Common Toolbar Control Icons

Common control icon functions are described in the following table. Specific function control icons are described in their applicable chapters. Displayed control icons vary depending on the active function or test. Select a control icon on a screen to activate a control function. You can also use the control buttons to activate a function, a yellow border around the icon indicates it is highlighted, or in focus. Use the Directional buttons (◀, ▶, ▲, ▼) to highlight the desired function and then press the Y/✓ button to select it.

Icon	Function	Icon	Function
	<b>Back</b> - Returns to the previously viewed screen. Icon is located on the left-hand edge of the toolbar.		<b>Record</b> - Indicates the data being displayed is paused and not being updated. Selecting resumes data collection.
	<b>Home</b> - Returns to the Home screen. Icon is located next to the Back icon on the left side of the toolbar.		<b>Tools</b> - Opens the tools menu.
	<b>Save</b> - Writes data from buffer memory to a file. The saved "movie" file can be accessed for future reference by selecting <b>Previous Vehicles and Data &gt; View Saved Data</b> .		
<i>The control icons below are used to navigate through paused or saved "movie" files during playback.</i>			
	<b>Step Forward</b> - allows forward movement in singular steps. To quickly step forward, select this icon (yellow frame appears) then press and hold the Y/✓ button. <b>(Note:</b> To quickly step forward during Scanner data playback, press and hold the icon down until a red frame appears around the icon.)		<b>Step Back</b> - allows backward movement in singular steps. To quickly step backward, select this icon (yellow frame appears) then press and hold the Y/✓ button. <b>(Note:</b> To quickly step backward during Scanner data playback, press and hold the icon down until a red frame appears around the icon.)
	<b>Skip Forward</b> - allows forward movement in multiple steps. To quickly skip forward, select this icon (yellow frame appears around icon) then press and hold the Y/✓ button		<b>Skip Back</b> - allows backward movement in multiple steps. To quickly skip backward, select this icon (yellow frame appears around icon) then press and hold the Y/✓ button.

### 3.2.5 Scroll Bar

A vertical scroll bar appears along the right-hand edge of the screen when additional data expands above or below what is currently on the screen (Figure 3-2).

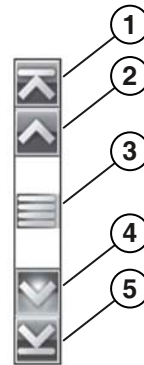

Figure 3-2 Scroll bar

- 1 **Beginning** - Moves to beginning of data displayed
- 2— **Step up** - Moves up one increment of the data displayed
- 3 **Slider (position indicator)** - Select and drag the **Slider** to scroll through data. The slider indicates the relative position of the current screen to the total available data.
- 4— **Step down** - Moves down one increment of the data displayed
- 5— **End** - Moves to end of data displayed

The Up (▲) and Down (▼) directional buttons can also be used to move through the data one line at a time. Press and hold a directional button to rapidly scroll through data.

## 3.3 Screen Messages

### 3.3.1 System Messages

There are four types of system messages that may be displayed:

Message Type	Description
<b>Loading and Connecting</b>	Loading and connecting messages display when the Diagnostic Tool is performing an internal operation, such as loading a database, establishing communications with the vehicle, or initiating a test. The message automatically clears once the internal operation is complete.
<b>Confirmation</b>	Confirmation messages inform you when you are about to perform an action that cannot be reversed or when an action has been initiated that requires a confirmation to continue. When a response is not required, the message displays briefly, then disappears.
<b>Warning</b>	Warning messages inform you when completing the selected action may result in an irreversible change or in the loss of data. A confirmation is required to continue.
<b>Error</b>	Error messages inform you when a system or procedural error has occurred, for example if the data cable becomes disconnected during operation.

### 3.3.2 Communication Messages

When “no communication” messages are displayed, it indicates the Diagnostic Tool and the vehicle electronic control module are not communicating.

The following conditions cause “no communication” messages to display:

- The Diagnostic Tool is unable to establish a communication link with the vehicle.
- The vehicle is not equipped with the system that was selected.
- There is a loose connection.
- There is a blown vehicle fuse.
- There is a wiring fault on the vehicle.
- There is a circuit fault in the data cable or adapter.
- Incorrect vehicle identification was entered.

Refer to the Vehicle Communication Software manuals for manufacturer-specific problems.

## 3.4 Data Cable Connection

Connection of the data cable to the Diagnostic Tool and vehicle DLC is required for Scanner and OBD-II/EOBD testing.

Depending on the vehicle, the supplied DA-4 data cable may be used alone or may require optional adapters.

- **All OBD-II/EOBD compliant vehicles** - Use the supplied DA-4 data cable. The 26-pin end of the cable attaches to the data cable connector on the top of the Diagnostic Tool. The 16-pin end connects to the vehicle DLC. The cable connectors are secured with captive screws.
- **All non-OBD-II/EOBD (OBD-I) compliant vehicles** - Use the supplied DA-4 data cable with the optional DA-5 adapter and a manufacturer specific adapter. The 26-pin end of the cable attaches to the data cable connector on the top of the Diagnostic Tool. The 16-pin end connects to the DA-5 adapter, the DA-5 adapter connects to the manufacturer specific adapter and then connects to the vehicle DLC. The cable connectors are secured with captive screws.

On-screen cable and adapter connection instructions are provided while using the Scanner and OBD-II/EOBD functions. The instructions may also include the location of the vehicle DLC ([Figure 3-3](#)). If required, additional connection information can be found in the appropriate vehicle communication software manual for the vehicle. Vehicle communication software manuals are available online, see the website information at the front of this manual



Connect: DA-4 Cable.  
Location: Under drivers side dash.

**Figure 3-3** Vehicle connection data cable message

For data cable vehicle power connection information, see "[Vehicle Power](#)," on page 10.



### To connect the data cable to the vehicle:

1. Follow the on-screen instructions for connecting to the vehicle ([Figure 3-3](#)).
2. Select **Continue** once the data cable is connected.  
The Diagnostic Tool establishes communication then displays a list of available tests. If the Diagnostic Tool is unable to establish a communications link, a "no communications" message displays.
3. Select from the available tests to open a submenu of test options.



This chapter describes the basic operation of the Scanner function.



The **Scanner** icon is located on the Home screen.

The Scanner function allows your Diagnostic Tool to communicate with the electronic control systems of a vehicle. This allows you to retrieve diagnostic trouble codes (DTCs), view PID data and perform diagnostic tests.

## 4.1 Screen Layout and Toolbar Icons

The following screen layout and toolbar controls apply to both the Scanner and the OBD-II/EOBD functions.

### 4.1.1 Screen Layout

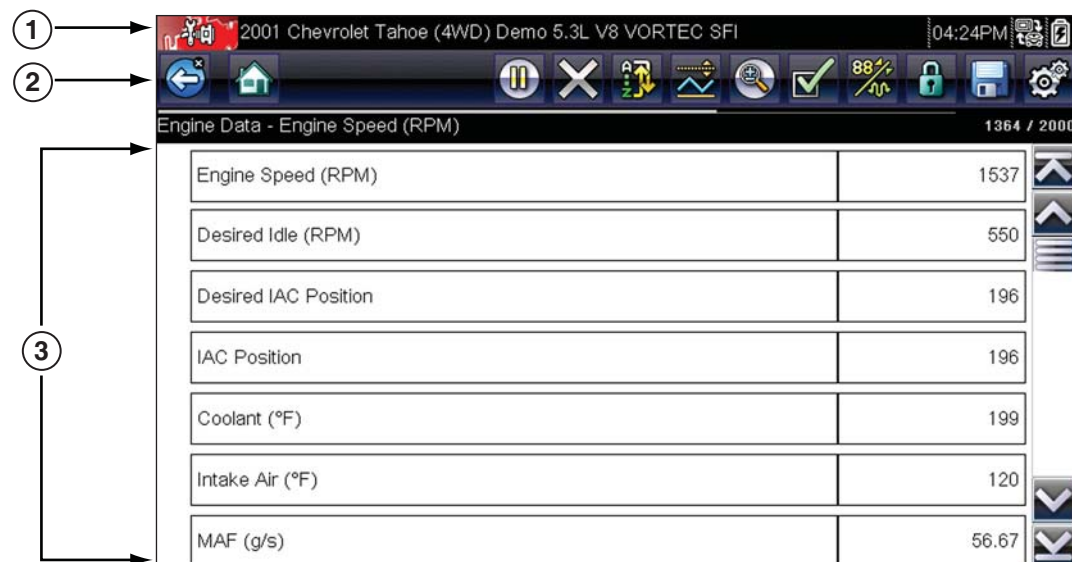









- 1— **Title bar**—shows active test, vehicle and Diagnostic Tool status
- 2— **Toolbar**—contains control icons
- 3— **Main body**—displays menus, PID and test data

**Figure 4-1** Screen layout

The Title bar appears for all functions and displays information only, there are no selectable items. Refer to [Title Bar](#), on page 14 for details.

## 4.1.2 Scanner Control Icons

The scanner toolbar contains control icons. Control icons may vary depending on the active function or test. A yellow frame surrounding an icon (highlighted), indicates it is selected. Other control icons (not shown) are described in [Common Toolbar Control Icons](#), on page 16.

Icon	Function	Icon	Function
	<b>Pause</b> - Indicates PID data from the vehicle is being displayed. Selecting pauses data collection.		<b>Custom Data List</b> - Opens a menu for selecting which PIDs display in the list.
	<b>Clear</b> - Erases all the PID data in the buffer and begins a new recording. Selecting opens a confirmation message.		<b>Change View</b> - Changes display options between PID list or graph displays.
	<b>Trigger</b> - Opens a menu that allows you to set, arm, and clear threshold values that automatically trigger PID data to be saved from buffer memory to a file.		<b>Lock/Unlock</b> - Locks or unlocks the highlighted parameter. Locked PIDs move to the top of the list and do not scroll as you move through the data.
	<b>Zoom</b> - Incrementally increases and decreases the scale of the data being displayed.		<b>Sort</b> - Determines the order in which PIDs are listed on the screen.

## 4.2 Scanner Demonstration Program

The Scanner demonstration program contains actual ECM PID data that allows you to navigate and become familiar with the many capabilities of the Scanner function without actually connecting to a vehicle. The following sections in this chapter provide detailed information on navigating through the Scanner function and various menus. As you navigate through the Demonstration program, refer to the applicable section for additional information.



### To start the demonstration program:

1. From the Home screen, select the **Scanner** icon.  
The manufacturer menu displays.
2. Select the **Demonstration** icon.

---

### IMPORTANT:

Do not connect a vehicle to the Diagnostic Tool while using the Demonstration program.

---

3. Follow the on-screen instructions and make the selection as needed until the confirmation screen displays.
4. Select **OK** on the confirmation screen to load the demonstration database.  
A message displays "Demo mode: Do not connect to vehicle."
5. Select **Continue**.  
A systems menu, which shows all of the systems available for testing, displays.
6. Select a system from the menu, then select submenus as applicable to display the desired demonstration information.

## 4.3 Scanner Operation

Starting Scanner opens a menu list of vehicle manufacturers and begins the process by identifying the vehicle being tested. After the vehicle is identified, a vehicle system is selected and then a specific test or function is selected to allow you to retrieve diagnostic trouble codes (DTCs), view and save PID data, or perform diagnostic tests.



### Basic Scanner Testing Procedure

1. **Start Scanner**—Select the **Scanner** icon on the Home screen.
2. **Identify the vehicle**—Identify the test vehicle by selecting from the menu options.
3. **Connect the data cable to the vehicle**—Follow the on-screen connection instructions to connect the Diagnostic Tool to the test vehicle.
4. **Select the system**—Select the system to be tested from the systems menu.
5. **Select the test from the main menu**—Select the desired test.

### 4.3.1 Vehicle Identification

The Diagnostic Tool displays PID data provided by the vehicle ECM. The vehicle must be correctly identified for the Diagnostic Tool to communicate and display PID data correctly. The vehicle identification sequence is menu driven, follow the screen prompts to enter the information. Exact procedures may vary by the make, model, and year of the vehicle.



#### To identify a vehicle for testing:

1. Select the **Scanner** icon on the Home screen.  
A list of manufacturers displays ([Figure 4-2](#)).

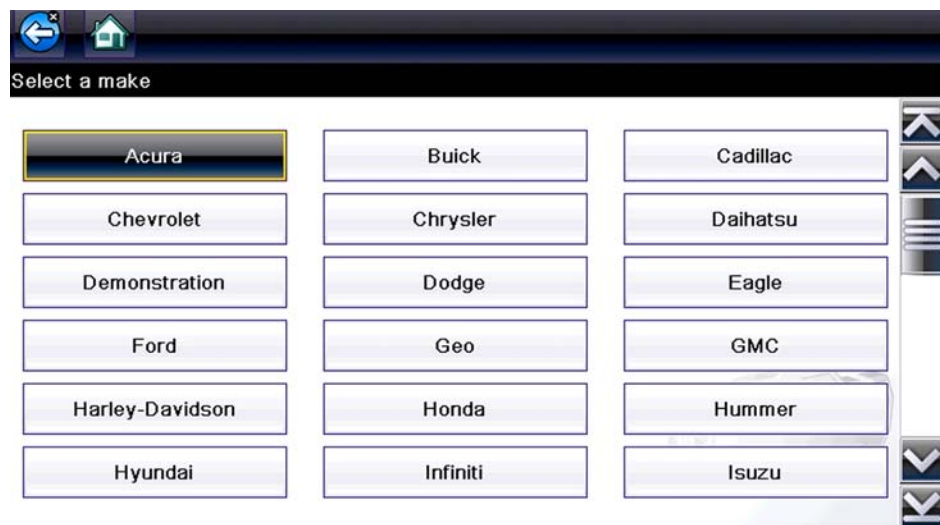

Figure 4-2 Manufacturer list

The list includes Demonstration, which opens the Demonstration program (see [Scanner Demonstration Program](#), on page 21).

2. Select the vehicle manufacturer from the list.

A model year menu displays.

3. Select the vehicle year from the menu.

A list of vehicle types or models displays. Several selections may be required to complete the vehicle identification, follow the screen prompts to enter the required information.

A confirmation screen displays once all the required information has been entered ([Figure 4-3](#)).

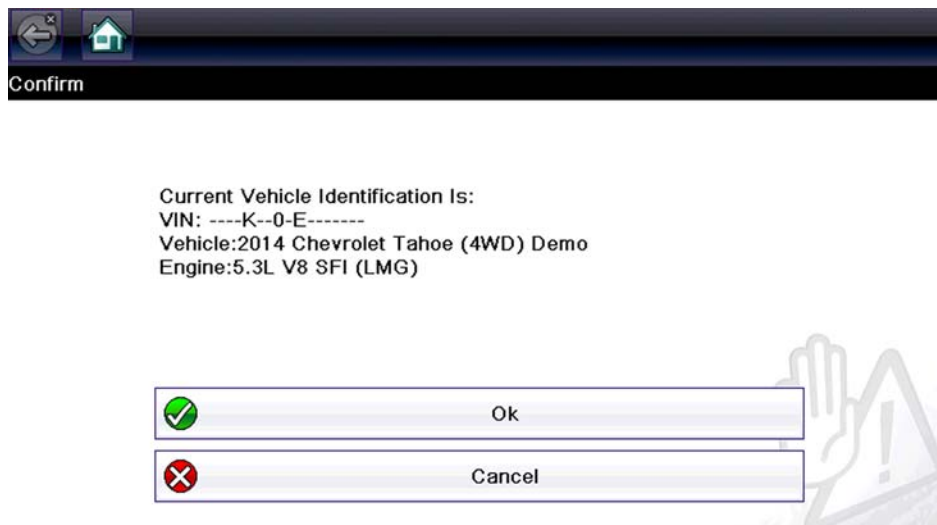

**Figure 4-3** Vehicle confirmation screen

4. From the Confirm Vehicle screen select:
  - a. **OK** to continue.
  - b. **Cancel** to return to the previous screen.

### 4.3.2 Connecting the Data Cable

Connection of the data cable to the Diagnostic Tool and vehicle DLC is required for Scanner testing, see [Data Cable Connection](#), on page 19.

### 4.3.3 System and Test Selection

After a vehicle is selected, a menu of available systems is displayed. Select a system to continue.



Figure 4-4 Available systems list



**NOTE:**

Only the systems available for testing on the identified vehicle are included in the list.

After a system is selected and the Diagnostic Tool establishes communication with the vehicle, a menu of available tests is displayed.



Figure 4-5 Main menu

Main menu options vary slightly by the year, make, and model of the test vehicle. The main menu may include:

- **Codes Menu**—displays diagnostic trouble code (DTC) records from the vehicle electronic control module. Selecting may open a submenu of viewing options.
- **Clear Codes**—erases DTC records and other data from the ECM. This selection is found on a Codes submenu for some models.
- **Data Display**— displays PID data from the vehicle electronic control module. Selecting may open a submenu of viewing options.
- **Functional Tests**—provides specific subsystem tests. The tests vary depending on the manufacturer and model.
- **Actuator Tests**—similar to functional tests, checks the operation of certain actuators, such as solenoid valves and relays.
- **Memory Resets**—allows you to reprogram adaptive values for certain components after making repairs. Selecting opens a submenu. These options are found on the Functional Tests Menu for some models.
- **System Tests**—provides specific subsystem testing. Performing these tests is similar to functional tests.
- **Generic Functions**—lets you access certain available Generic OBD II functions from a proprietary menu (1996 and newer vehicles only).
- **Troubleshooter**—provides step-by-step procedures, integrating PIDs and retrieving trouble codes when appropriate, for specific symptoms of the identified vehicle.

## Codes Menu

This selection may appear as Codes, Codes Menu, Codes Only, Codes (No Data), Service Codes or something similar on the menu. Selecting opens a list of viewing options that includes:

- [Display Codes](#)
- [Clear Codes](#), on page 31
- [Freeze Frame/Failure Records](#), on page 31

### Display Codes

This function opens either a list of diagnostic trouble codes (DTCs) stored in the selected vehicle electronic control module (ECM), or a submenu of DTC viewing options. The code list includes the DTC and a brief description ([Figure 4-6](#)).

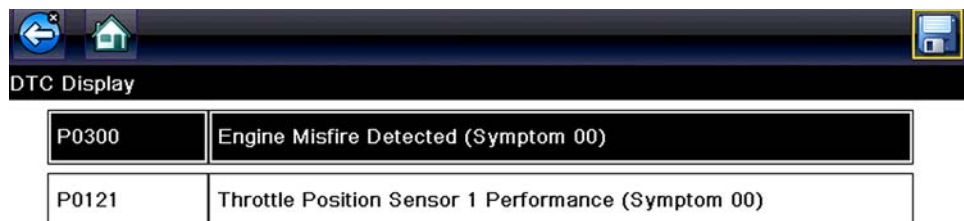

Figure 4-6 DTC results

Submenu options may include:

- **Trouble Code Information**—opens a list of codes in ECM memory
- **History Codes**—opens a list of codes whose symptoms are not currently present. History codes indicate an intermittently occurring problem.
- **Failed This Ignition**—opens a list of codes that set during the current ignition cycle.
- **MIL SVS or Message Requested**—displays ECM requests to turn on the malfunction indicator lamp (MIL) or service vehicle soon (SVS) lamp, or display a driver information alert.
- **Last Test Failed**—displays a complete list of failed tests.
- **Test Failed Since Code Cleared**—displays a list of tests that failed since the last time codes were cleared from ECM memory.

### Saving and Reviewing Codes

Selecting the **Save icon** ([Figure 4-1](#)) saves the displayed DTC results list as an (.XML) file. The (.XML) file can be reviewed later, by selecting **Previous Vehicles and Data > View Saved Data** and then selecting the (.XML) file from your saved file list ([Figure 4-7](#)). When opened, the (.XML) file displays basic vehicle information and a list of DTCs with a brief description of each.



Figure 4-7 Typical - DTC (.XML) files in the **View Saved Data** list

Saved (.XML) files can also be transferred to a personal computer (PC) using ShopStream Connect. Once the Diagnostic Tool is connected to the PC, (.XML) files can be printed, transferred, and copied. ShopStream Connect is a companion program that is available online, at no charge. See the ShopStream Connect website information at the front of this manual to visit the website and download the application.



**NOTE:**

(.XML) files transferred with ShopStream Connect are text files containing vehicle information, and the DTC list. The files can be viewed and printed from ShopStream Connect (Figure 4-8).

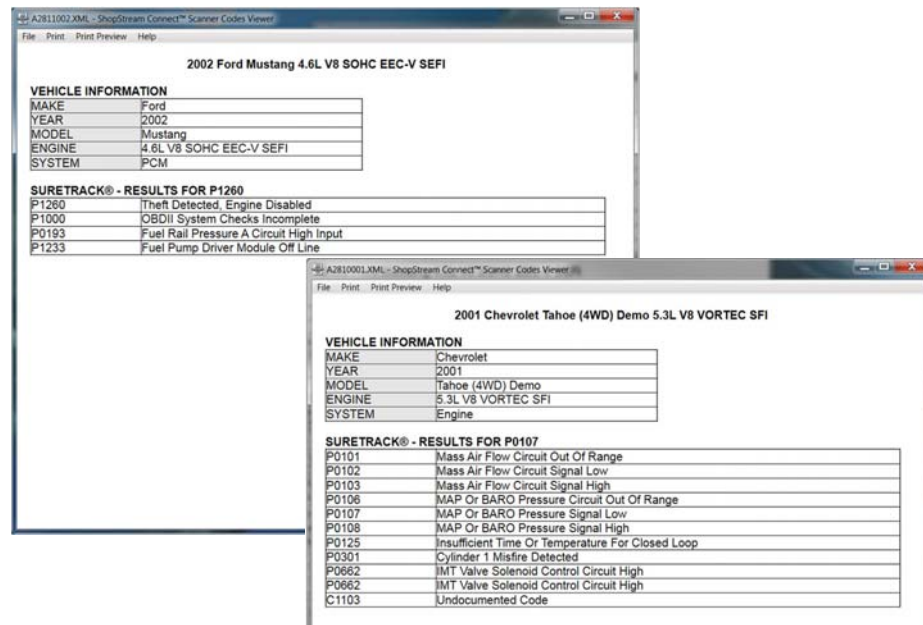

Figure 4-8 Typical - (.XML) files, viewed in ShopStream Connect



### Code Scan

One of the benefits of performing a code scan is that you can quickly show your customer diagnostic related issues with a pre scan report, and then after repairing the issues you can use the post scan report to show that the repairs were completed (Figure 4-9). In addition, by using ShopStream Connect the reports can be given to the customer and also saved for your own records, for more information, see [ShopStream Connect](#), on page 69.

**IMPORTANT:**

PRE / POST Scan Importance - As many systems do not turn on the check engine light or other indicator, performing a vehicle code scan before making any repairs may help in troubleshooting, by identifying possible unknown issues that may be related to the present symptoms.

Performing pre and post scans also allows you to record in report format the pre-condition of the vehicle and compare the post scan after work is complete to confirm the repairs were completed properly.

Pre and post scan is required by some manufacturers for pre and post collision work as well as by some insurance companies.

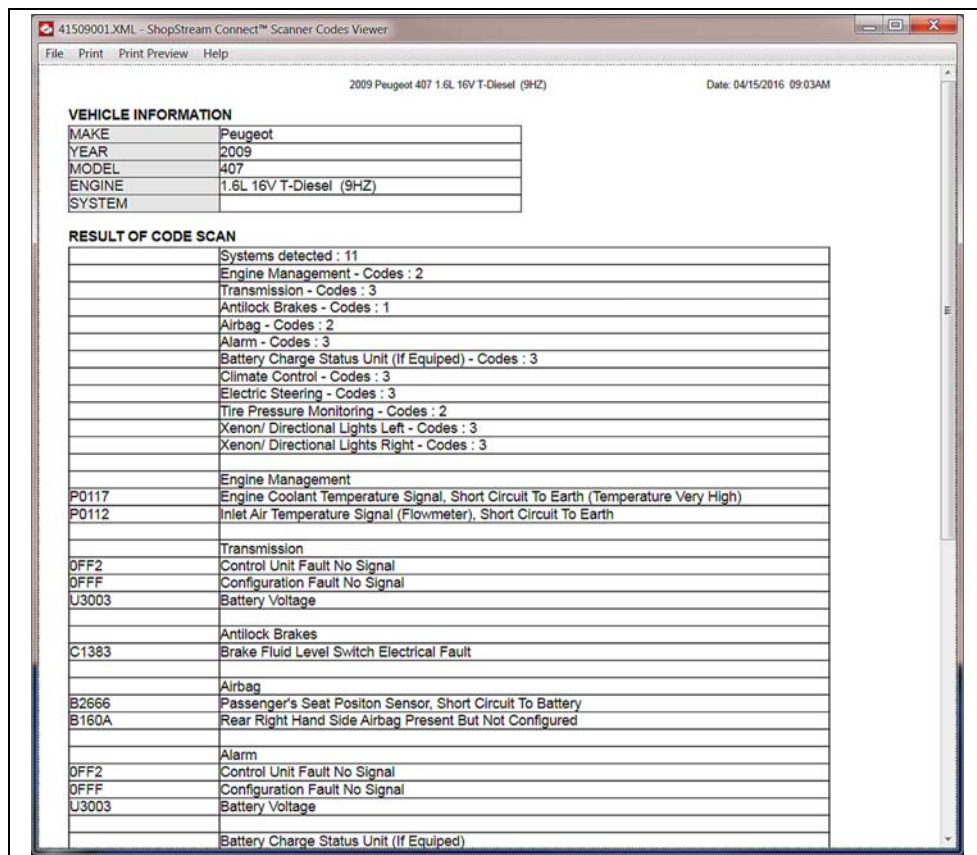



Figure 4-9 Typical Code Scan Report in Shopstream Connect

Depending on the vehicle, Code Scan (if supported) may be available from the Systems menu. Selecting **Code Scan** starts an active scan of vehicle control modules, and opens the Code Scan results screen (Figure 4-10). A progress indicator is shown at the top indicating the active scanning progress. Once completed, the results are displayed by system category.

The following Code Scan related control icons are used:

Icon	Function
	<b>Refresh</b> - Restarts the code scan
	<b>System</b> - Opens the main menu of the system selected

The following results are displayed progressively as the modules are scanned:

- **The total number of systems (modules) detected** (Figure 4-10).

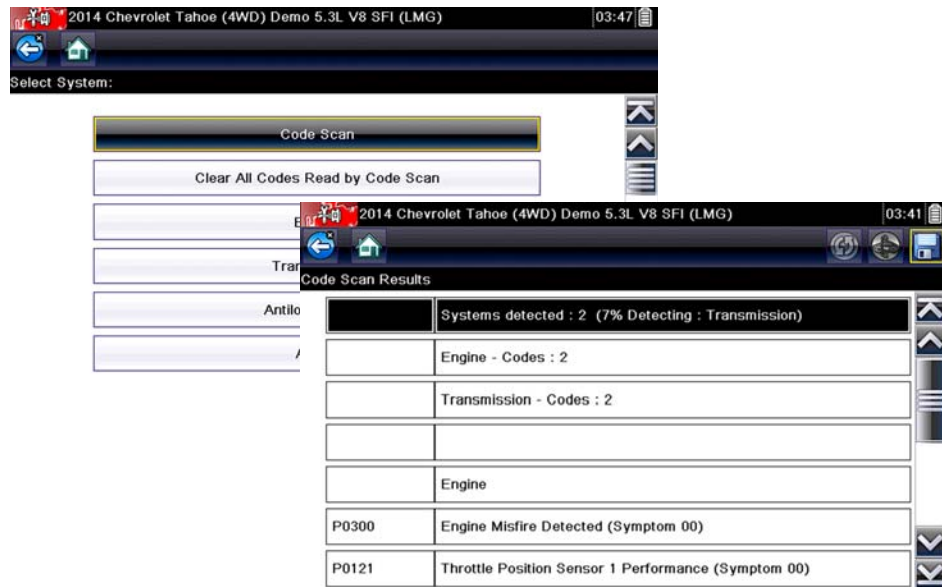

Figure 4-10 Code Scan systems analyzed result total

- **A list of all the systems analyzed with DTCs totals.** A categorized system list with DTC totals is displayed in the order they are scanned. To view the main menu for a system in the list, select the system, then select the **System** icon (Figure 4-11).

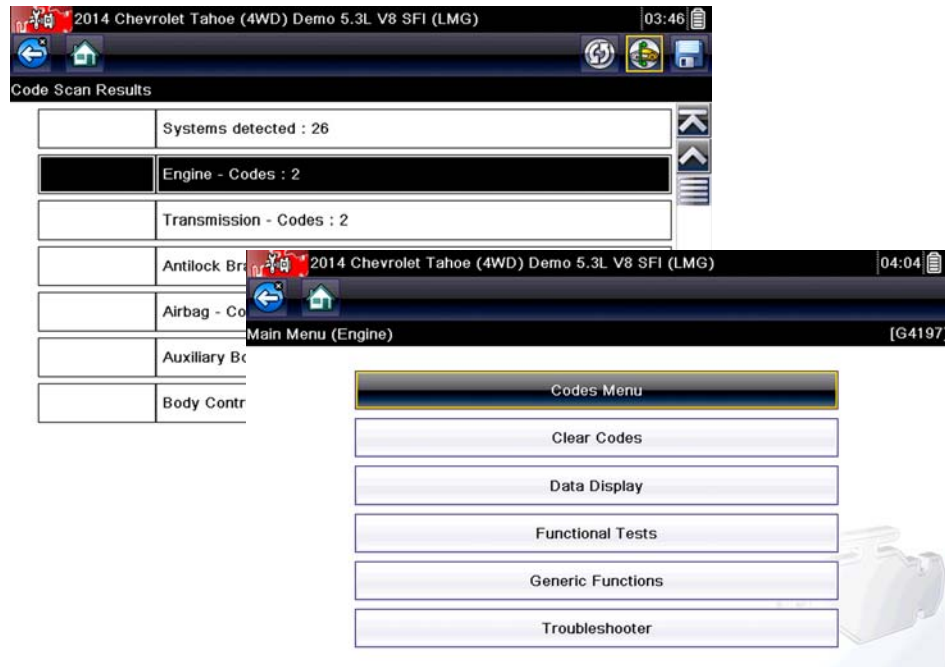

Figure 4-11 System icon (opens Main Menu)

### Saving Codes, and Code Scan Results)

When using the code scan feature, or when viewing individual system codes (e.g. engine, transmission) selecting the **Save** icon from the toolbar saves the results as a data file.

The saved file(s) can be viewed using two methods:

- On the diagnostic tool - See [View Saved Data](#), on page 53.
- Using ShopStream Connect - See [ShopStream Connect](#), on page 69.

### Printing the Code Scan Report

The vehicle system report can also be customized and printed using ShopStream Connect - See [Printing the Code Scan Report](#), on page 73.

### Clear All Codes Read by Code Scan

Selecting **Clear All Codes Read by Code Scan** erases all DTCs from all vehicle system modules that were read by Code Scan.



#### NOTE:

**Clear All Codes Read by Code Scan** may not clear global OBD-II codes on some vehicles.

### Clear Codes

The Diagnostic Tool clears codes from the vehicle electronic control module memory on most vehicles. If this function is not available on the test vehicle, Clear Codes does not appear as a menu option.



#### NOTE:

Clear Codes is also available from OBD-II Health Check (see [OBD Health Check](#), on page 43).



#### To clear codes:

1. Select **Clear Codes** from the Codes Menu.  
A confirmation message displays.
2. Make sure any conditions shown on the confirmation message are met, then select **Yes**.  
A “codes cleared” message displays once the operation is complete.
3. Select **Continue** to return to the Codes Menu.

#### IMPORTANT:

Clearing codes erases all temporary ECM information, including Freeze Frame/Failure Records. Make sure no vital diagnostic information will be lost before clearing codes.

### Freeze Frame/Failure Records

This selection displays the DTC that was set, along with corresponding data, when the ECM commanded the malfunction indicator lamp (MIL) to turn on.

### Data Display

Select **Data** to view PID data from the vehicle ECM. In data display mode the screen has a toolbar and a main body ([Figure 4-12](#)).

The screenshot shows a software interface for displaying engine data. At the top, there is a toolbar with various icons including a home button, a back button, a pause button, a close button, a refresh button, a zoom in/out button, a checkmark, a battery level indicator (88%), a lock icon, and a settings gear. Below the toolbar, the title bar reads "Engine Data - Engine Speed (RPM)" and "1364 / 2000". The main content area is a table with the following data:

Engine Speed (RPM)	1537	↑
Desired Idle (RPM)	550	↑
Desired IAC Position	196	⋮
IAC Position	196	⋮
Coolant (°F)	199	⋮
Intake Air (°F)	120	⋮
MAF (g/s)	56.67	⋮

Figure 4-12 Data display screen

The toolbar control icons are described in [Scanner Control Icons](#), on page 21 and [Common Toolbar Control Icons](#), on page 16.

During data display the main body of the screen is divided into two columns; the left-hand column has a description of the parameter and the right-hand column shows the parameter value or state. Parameters are listed in the order in which they are transmitted by the ECM, so expect variations between years, makes, and models.

Up to three parameters can be locked, or fixed, at the top of the list. Locked parameters do not change as you scroll through the parameter list. The **Lock/Unlock** icon on the toolbar selects which parameters are fixed (see [Locking Parameters](#), on page 34).

Displayed data may also be paused or saved for detailed review and future reference, see [Saving Files](#), on page 36 and [Pausing and Reviewing Data Files](#), on page 37.

### Customizing the Data List

The **Custom Data List** icon on the toolbar is used to determine which specific parameters display. Minimizing the number of parameters on the data list allows you to focus on any suspicious or symptom-specific data parameters. You can add or remove most parameters from the list. Certain vital parameters may not be removed. These appear in gray at the top of the list along with a lock icon, and they cannot be selected.



#### NOTE:

Limiting the number of parameters that display to those that apply to a particular situation results in a faster data refresh rate, and reduces the amount of memory used for saved files.



#### To create a custom data list:

1. Select the **Custom Data List** icon on the toolbar to select it.

The data selection screen displays and two new icons appear on the toolbar. Check marks to the left of the parameter description indicate which parameters are selected for display. A second smaller check box indicates a parameter that is locked.

The toolbar icons provide options for selecting and deselecting parameters to include or remove from the custom data list:

Icon	Description
	<b>Select/Deselect</b> , use to mark individual parameters to hide or display. Any locked parameters cannot be deselected.
	<b>Select All/Deselect All</b> , use to hide or display all of the parameters in the list. Any locked parameters cannot be hidden.

2. Create a custom data list by selecting the parameters to include. A parameter that displays has a check mark alongside the name, a parameter that does not display does not. Select which parameters to display:
  - a. Selecting the **Select All/Deselect All** icon immediately changes all of the parameters to the same condition, a second push changes them all back.

- b. Selecting the **Select/Deselect** icon activates it. Now you can add or remove parameters by selecting individual entries in the list.

Note the following:

- Items at the top of the list that cannot be highlighted are locked and cannot be turned off.
- Use the **Select All** icon to display the complete list.
- Use the **Deselect All** icon to remove all of the highlights.

3. Select **Back** to display the updated data list.

### Changing Screen Views

Selecting the **View** icon opens a drop-down menu of options:

- PID List
- 1 Graph
- 2 Graph
- 4 Graph

The PID (parameter identification) List view is a 2-column display with the name of the parameters in the left column and their current values in the right column (Figure 4-12).

The 1, 2, and 4 Graph views divide the screen horizontally to simultaneously display data graphs for the indicated number of parameters (Figure 4-13). Use the scroll bar or the **up** (▲) and **down** (▼) icons to view other parameters in the list.

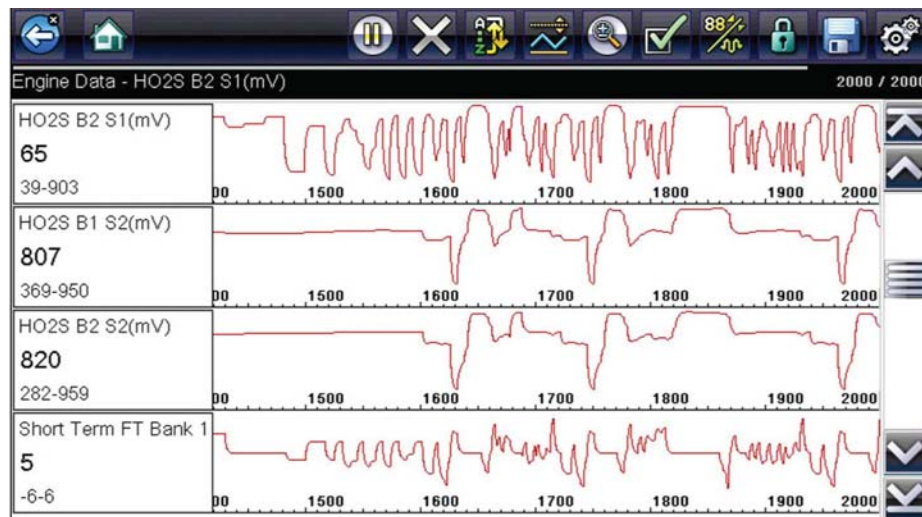

Figure 4-13 Four graph view



#### NOTE:

Any previously set conditions, such as held data or locked lines of data, remain in effect when the screen view is changed.

### Locking Parameters

Use the **Lock/Unlock** icon to hold selected lines of the data in place and prevent them from scrolling, or to release previously locked lines of data. Up to three lines of data may be held at a time. This feature allows you to position related parameters together, making it easier to monitor their values and spot inconsistencies.

Locked parameters display as the top frames on the main body of the display screen, as well as at their usual position within the data list (Figure 4-14). A lock icon appears to the left of the parameter name to indicate it is locked.



#### To lock parameters:

1. Highlight the parameter to be locked.
2. Select the **Lock/Unlock** icon on the toolbar to lock it.

A copy of the locked parameter is now shown at the top of the data list, and a lock icon appears alongside the parameter name.

3. Highlight and select additional parameters to lock.

Up to three parameters can be locked at a time. Once locked, a parameter remains locked until it is manually unlocked or communication with the vehicle stopped.

Engine Data - Fuel Trim Learn		2000 / 2000
	HO2S B1 S1(mV)	113
	HO2S B1 S2(mV)	781
	Short Term FT Bank 2 (%)	5
	Long Term FT Bank 1 (%)	12
	Long Term FT Bank 2 (%)	11
	Fuel Trim Learn	Enabled
	Fuel Trim Cell	14

Figure 4-14 Locked parameters



#### NOTE:

If three parameters are locked, one of them must first be unlocked before another parameter can be locked.



#### To unlock parameters:

1. Scroll through the data list and highlight the parameter to be unlocked, or released.
2. Select the **Lock/Unlock** icon on the toolbar.

The released parameter and the lock icon disappear from the list at the top of the data list.

3. Repeat Step 1 and Step 2 to release other parameters if needed.



### Setting Trigger Levels

The trigger icon allows you to configure the Diagnostic Tool to automatically save PID data from buffer memory to a file when a parameter value crosses a threshold. When triggering is armed, a "Trigger event" pauses data collection and saves data to a file.

Selecting the **Trigger** icon opens a menu that includes:

- **Set Trigger**—establishes upper and lower signal values to initiate an event capture for the highlighted parameter.
- **Arm Trigger**—activates the Diagnostic Tool to capture an event when the signal crosses a threshold value.

Trigger lines change colors to indicate the trigger is armed.

- **Clear All Triggers**—deletes all previously set trigger levels.

If triggers are set the menu options are:

- **Clear Trigger**—deletes set trigger levels for the highlighted parameter.
- **Disarm Trigger**—de-activates event capture capability.
- **Clear All Triggers**—deletes all previously set trigger levels.



#### To set trigger levels:

1. Highlight the parameter to be used for triggering the recording.
2. Select the **Trigger** icon.
3. Select **Set Trigger** from the drop-down menu.

A graph of the highlighted parameter with a trigger toolbar above it fills the main body of the screen (Figure 4-15).



Figure 4-15 Trigger set screen

The trigger level line displays as a solid line running horizontally across the data graph. An upper and lower trigger level must be set, the upper level is set first.

4. Select the plus (+) and minus (-) icons on the toolbar, or use the up ▲ and down ▼ arrow buttons to position the upper trigger level to where you want it on the graph.



5. Select ✓ on the toolbar, or press the **Y/✓** button, to set the upper threshold.  
A lower trigger level line now appears at the mid-point of the graph.
6. Select the plus (+) and minus (–) icons on the toolbar, or use the up ▲ and down ▼ arrow buttons to position the lower trigger level line to where you want it on the graph.
7. Select ✓ on the toolbar, or press the **Y/✓** button, to set the lower threshold.

The display returns to the PID data view and the trigger points appear as horizontal lines across the designated parameter graph. Repeat this procedure to establish trigger points for other parameters if desired. Once armed, any data points that register outside of your set conditions pause data collection and save data to a file.

**NOTE:**

Only three parameters can have trigger levels set at one time, but only one of the conditions needs to be satisfied for triggering to occur.

---

**To arm triggers:**

1. Select the **Trigger** icon on the toolbar.
2. Select **Arm Triggers** from the drop-down menu.

The trigger lines on the data graphs change color to indicate an armed condition.

Triggers for all of the graphs are armed simultaneously. Once triggering is armed, it remains in that state until you switch it off. If trigger settings are modified or are added for other parameters, they are armed as soon as you exit the setting screen.

## Saving and Reviewing Scanner / OBD-II/EOBD Data Files

The following procedures are used when saving and reviewing data files for Scanner and OBD-II/EOBD.

### **Saving Files**

During normal operation, data from the vehicle's ECM is continuously being stored in buffer memory as it is displayed onscreen. Buffer memory is limited to a predetermined "total" size and is displayed on the counter (located below the toolbar on the right side of the screen) ([Figure 4-17](#)).

Selecting **Save** writes the stored buffer memory to a file. Saving data is useful when trying to isolate an intermittent problem or to verify a repair during a road test. The saved file can be played back (similar to a movie clip) by selecting **Previous Vehicles and Data > View Saved Data**. See [View Saved Data](#), on page 53 for additional information.

**NOTE:**

The **Save icon** performs the same function as "Save Movie" function choice for the programmable **Shortcut** button, see [Configure Shortcut Button](#), on page 57 for details.

---

The saved data file can also be downloaded to a personal computer (PC) using the Mini USB jack. Once connected to the PC, the data files can be printed, transferred, and copied using ShopStream Connect. ShopStream Connect is an application that creates an interface between the Diagnostic Tool and a PC. The ShopStream Connect application is available free online, see the ShopStream Connect website information at the front of this manual for additional information.

The toolbar control icons are described in [Scanner Control Icons](#), on page 21 and [Common Toolbar Control Icons](#), on page 16.



#### To save data:

- Select **Save**.

A save dialog box displays while data is being saved. The data is saved when the message box disappears.

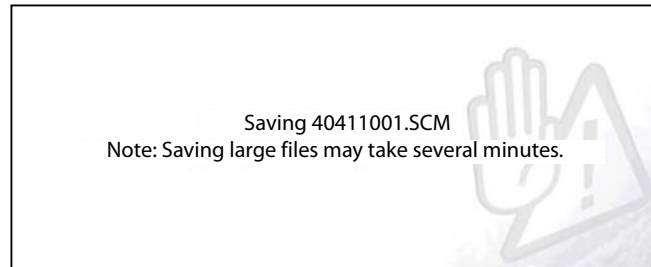

Figure 4-16 Save dialog box

### **Saving Screens**

The **Shortcut** button can be programmed to save a snapshot of a visible screen as a bitmap file, see [Configure Shortcut Button](#), on page 57 for details. The saved file can be viewed by selecting **Previous Vehicles and Data > View Saved Data.**, see [View Saved Data](#), on page 53 for additional information.

### **Pausing and Reviewing Data Files**

During normal operation, data from the vehicle's ECM is continuously being stored in buffer memory as it is displayed onscreen. The Pause feature, allows you to temporarily pause data collection to review it in detail.



#### To pause and review data

Toolbar control icons are described in [Scanner Control Icons](#), on page 21 and [Common Toolbar Control Icons](#), on page 16.

1. While viewing data, select the **Pause** icon.

On the toolbar, the playback control icons are displayed. A counter displays along the right-hand edge of the screen between the toolbar and the main body. A bar graph to the left of the counter shows how much data is in the memory buffer. A slider on the bar graph indicates the position of the current screen in relation to the entire contents of the data buffer.

Use the slider to quickly scroll through the data. Use the control icons to accurately position the cursor. The cursor (vertical line), indicates your position when in the graph mode, appears once you begin navigating (Figure 4-17).

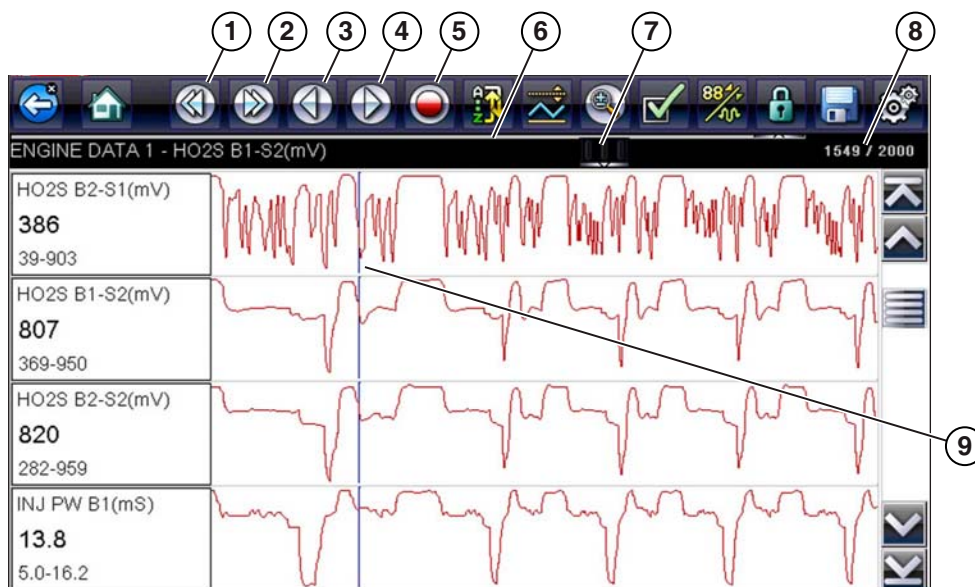

- |                 |                                       |
|-----------------|---------------------------------------|
| 1— Skip Back    | 6— Bar Graph                          |
| 2— Skip Forward | 7— Slider                             |
| 3— Step Back    | 8— Counter (current position / total) |
| 4— Step Forward | 9— Cursor                             |
| 5— Record       |                                       |

Figure 4-17

2. Scroll up or down to review the list of data.
3. Select the desired control icon to move forward or back incrementally in the selected direction.



**To resume:**

- Select the **Record** icon.

The display changes back to display data and the **Pause** icon is shown on the toolbar. A vertical rule runs through the data graph to indicate data was paused at that point.



**NOTE:**

The **Shortcut** icon can be set to perform the Pause/Play function. See [Configure Shortcut Button](#), on page 57 for additional information.

## Functional Tests

The **Functional Tests** selection is used to access vehicle-specific subsystem tests. Available tests vary by manufacturer, year, and model. Only the tests available for the identified vehicle display in the menu.

There are several types of functional tests:

- **Information Tests**—these are read-only tests, like selecting “VIN” from a Functional Tests menu to display the VIN of the identified vehicle.
- **Toggle Tests**—these tests switch a component, such as a solenoid, relay, or switch, between two operating states.
- **Variable Control Tests**—these tests command a certain value for a system or component, such as varying spark timing in 1° increments or EGR valve duty cycle in 10% increments.
- **Reset Tests**—these tests reset the adaptive, or learned, values that are stored in the vehicle electronic control module memory.
- **Scripted Tests**—these tests are software routines that place the vehicle into special operating modes for performing certain repairs, such as bleeding brakes with ABS.

Selecting Functional Tests opens a menu of test options that varies by make and model. Selecting a menu option either activates the test or opens a submenu of additional choices. Follow all screen instructions while performing tests. How and what information is presented on the screen varies according to the type of test being performed and the vehicle being serviced.

Toggle and variable control tests often display functional test controls on the toolbar at the top of the screen with PID data in the main body (Figure 4-18).



Figure 4-18 Functional test screen

A Test icon on the toolbar activates the test, and a Return, or similarly named, icon cancels the test. For variable control tests, the variable value displays between the main body and the toolbar. Plus and Minus icons on the toolbar increase and decrease the variable value.



A Data List icon, shown to the left, is available on the toolbar for some tests. This feature allows you to change which data list displays in the main body without exiting the functional test. The icon is only available when the test is inactive.

## Generic Functions

Generic Functions are used to perform generic OBD-II/EODB tests, for additional information see [OBD-II/EODB](#), on page 42.

## Troubleshooter

Fast-Track<sup>®</sup> Troubleshooter is a database of experience-based repair strategies and information, that has been compiled and validated by top-notch technicians. Troubleshooter simplifies the diagnosis process, as it contains information on virtually all common diagnostic trouble code (DTC) problems and driveability symptoms.

Troubleshooter information is organized into a series of diagnostic tips that are designed to quickly lead you to the root cause of a particular problem. The tips are vehicle-specific, which means only tips that relate to the identified vehicle are presented. Selecting opens a menu that may include:

- **Code Tips**—provides detailed information on setting conditions, testing, and interpreting test results for specific codes.
- **Symptom Tips**—provides diagnostic tests and procedures based on vehicle operation.
- **Time Savers**—provides supplemental information, such as firing order and #1 cylinder location, that may be needed to make a diagnosis.
- **Common Problems**—provides advice and remedies for certain “pattern failures” that have been experienced on vehicles of the same model.
- **Tests and Procedures**—explains how to perform certain tests on the specific test vehicle. Some tips provide specifications and installation information as well.
- **Fast-Track Data Scan**—contains information and guidelines on how to validate data readings for certain sensors and actuators, PID data values are provided.
- **Fast-Track Fixes**—provides actual repair information for related repairs.

**NOTE:**

Troubleshooter appears in a Scanner menu only if tips are available for the system selected on the identified vehicle.

---

Certain PID data parameter values display directly within the tip when performing Troubleshooter tests and procedures. A tip may also contain a hyperlink to a Troubleshooter Reference, another test or procedure, or a supplemental operation, such as Clear Codes. Hyperlinks are shown in blue, and selecting them opens the link. Troubleshooter References open in a separate window. (Figure 4-19).



P0325 sets when a malfunction with the KS system within the PCM are faulty. The DTC will set when the knock sensor voltage is too low or too high. If there are any abnormal engine noises present then repair it first. Now measure the resistance of the knock sensor it should be 90k to 110K ohms. If it is not then suspect the knock sensor. If it is okay then check the knock sensor circuit and wiring. Make sure the circuit is not routed near the secondary wires. Now clear the DTC and road test it under the conditions that set the DTC. If the DTC resets then suspect the knock sensor module or the PCM. Use care when installing the knock sensor and always torque to the correct specification. Damage to the sensor may occur if it is over torqued.

Tech Note:

Drivability Concern - Ensure that the vehicle is reaching factory recommended operating engine temperature. If this is not attained then multiple DTC's could be present along with the chance of miss diagnosing the customer complaint.

INFO: Select the information icon on the toolbar for more information.

Figure 4-19 Troubleshooter tip

## 4.4 Exiting Scanner

Scanner function remains open as long as there is an active communication link with the vehicle. You must interrupt this communication link in order to exit from tests and power down the Diagnostic Tool. A warning message displays if you attempt to shut down while the Diagnostic Tool is communicating with the vehicle.



### NOTE:

Damage to the vehicle electronic control module (ECM) may occur if communication is disrupted. Make sure the data cable is properly connected at all times during testing. Exit all tests before disconnecting the data cable or powering down the Diagnostic Tool.



### To exit the Scanner function:

1. From any active data screen, select the **Back** icon on the toolbar.  
A “stopping communications” message briefly displays followed by the Data menu.
2. From the Data Menu, select **Back** on the toolbar.  
Again, a “stopping communications” message briefly displays followed by the Main menu.

Now, the Diagnostic Tool is no longer communicating with the vehicle and it is safe to return to the Home screen and power down the Diagnostic Tool.

This chapter describes the basic operation of the OBD-II/EOBD function.



The **OBD-II/EOBD** icon is located on the Home screen.

The OBD-II/EOBD function allows you to access “generic” OBD-II/EOBD data. Generic OBD-II/EOBD data is data limited to emission related diagnostics such as:

- Checking for emissions-related diagnostic trouble codes (DTCs)
- Checking the cause of an illuminated malfunction indicator lamp (MIL)
- Checking monitor status prior to emissions certification testing

To access other available electronic control module (ECM) data for vehicle specific systems, parameters or enhanced diagnostics use the Scanner function, see “[Scanner](#)” on page 20.



---

**NOTE:**

The OBD-II/EOBD function can also be used to access “generic” OBD-II/EOBD data for OBD-II/EOBD compliant vehicles that are not included in the Scanner function databases.

---

## 5.1 Basic Operations

### 5.1.1 Screen Layout and Toolbar Controls

Screen layout and toolbar controls are similar to the Scanner function, see [Scanner Control Icons](#), on page 21.

### 5.1.2 Connecting the Data Cable

Connection of the data cable to the Diagnostic Tool and vehicle DLC is required for OBD-II/EOBD testing, see [Data Cable Connection](#), on page 19.

### 5.1.3 Saving and Reviewing Data Files

Save and Pause control icon operation and data review procedures are the same as used for the Scanner function, see [Saving and Reviewing Scanner / OBD-II/EOBD Data Files](#), on page 36.

## 5.2 OBD-II/EOBD Menu

The following options are available from the OBD-II/EOBD menu:

- [OBD Health Check](#)
- [OBD Direct](#)

### 5.2.1 OBD Health Check

The OBD-II Health Check offers a way to quickly check for and clear generic DTCs, and to check readiness monitors for emissions testing. Selecting opens a connection message, then a submenu of test options (Figure 5-1).

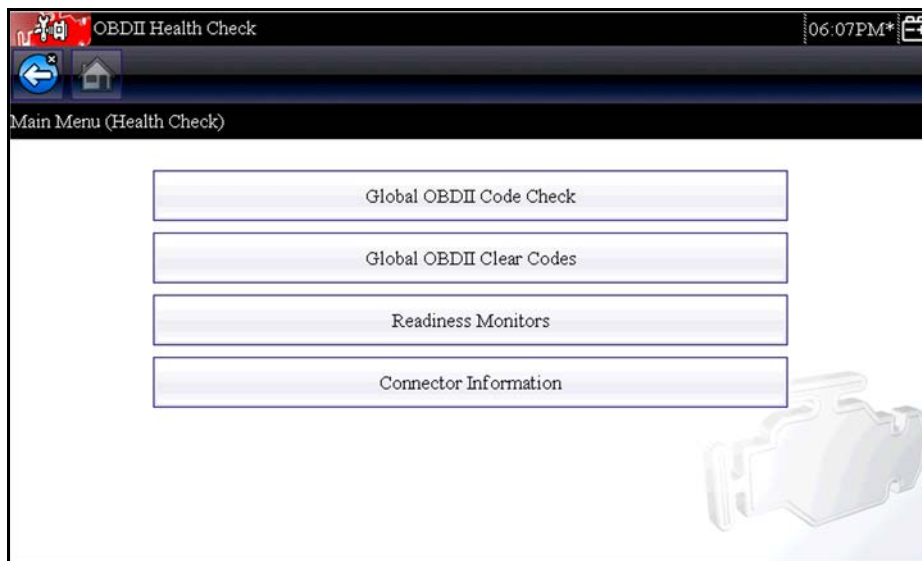

Figure 5-1 OBD Health Check menu

### Global OBD II Code Check

Global OBDII Code Check displays stored emission related generic DTCs reported by the ECM. Selecting this option opens a submenu with two choices: Codes and Pending Codes. Selecting either option opens a code list.

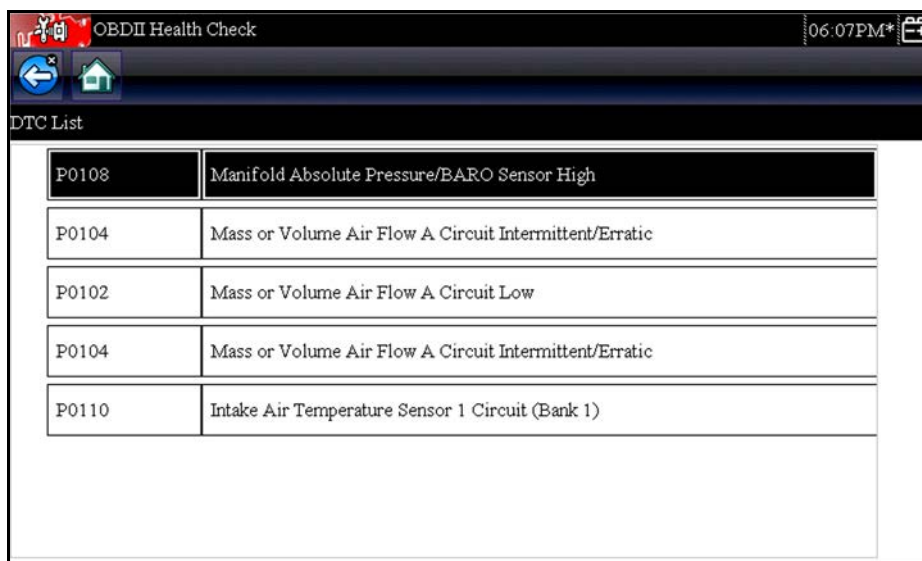

Figure 5-2 Code list



## Codes

The Codes option displays a list of current emission related DTCs.

OBD-II/EOBD Codes have a priority according to their emission severity, with higher priority codes overwriting lower priority codes. The priority of the code determines the illumination of the MIL and the code erase procedure. Vehicle manufacturers have implemented the ranking differently, so there are differences between makes.

## Pending Codes

The purpose of this service is to enable the Diagnostic Tool to obtain “pending” or maturing diagnostic trouble codes. These are codes whose setting conditions were met during the last drive cycle, but need to be met on two or more consecutive drive cycles before the DTC actually sets.

Use this service following a vehicle repair and code clearing procedure to verify test results after a single drive cycle.

- If a test failed during the drive cycle, the DTC associated with that test is reported. If the pending fault does not occur again within 40 to 80 warm-up cycles, the fault is automatically cleared from memory.
- Test results reported by this service do not necessarily indicate a faulty component or system. If test results indicate another failure after additional driving, then a DTC is set to indicate a faulty component or system, and the MIL is illuminated.

Refer to and the *Global OBD Vehicle Communication Software Manual* for additional information.

## Global OBD II Clear Codes

This option is used to clear all emission related diagnostic data, such as DTCs, freeze frame data, and test results, from the memory of the selected ECM. Although OBD-II/EOBD displays generic OBD-II/EOBD data only, clearing codes erases all of the stored data, including any enhanced codes and freeze frame information.

A confirmation screen displays when the clear codes option is selected to prevent accidental loss of data. Select Yes from the confirmation screen to continue. Refer to the *Global OBD Vehicle Communication Software Manual* for additional information.

## Readiness Monitors

Use to check the readiness status of the monitoring system. An OBD-II /EOBD system checks the status of emission-related subsystems by running continuous or periodic tests. Two viewing options are available once Readiness Monitors is selected:

- **Monitors Complete Since DTC Cleared**—displays the status of all monitors that have run since the last time DTCs were erased.
- **Monitors Complete This Cycle**—displays the status of the monitors that ran during the current drive cycle only.

Select either option and test results are shown in the data viewer ([Figure 5-3](#)).

OBD-II/EOBD		04:33PM
ID : \$	10	105 / 2000
MISFIRE	TEST COMPLETE	
FUEL SYSTEM	TEST COMPLETE	
COMPONENTS	TEST COMPLETE	
CATALYST	NOT COMPLETE	
HEATED CATALYST	NOT SUPPORTED	
EVAPORATIVE SYSTEM	NOT COMPLETE	

Figure 5-3 Readiness monitor test report

Scroll to view the entire list of Readiness Monitors to ensure that all tests are complete. It is possible to save the monitor report as part of the vehicle records. Select **Save** from the toolbar and follow the screen prompts.

## MIL Status

This test checks the ECM commanded state (on or off) if the malfunction indicator lamp.

## 5.2.2 OBD Direct

OBD Direct includes the following menu and submenu choices:

- **OBD Diagnose**
  - **Start Communication** - initiates a test session
  - **Connector Information** - provides DLC location details
  - **Manual Protocol Selection** - provides choices for communication protocol
- **OBD Training Mode** - allows you to familiarize yourself with the capabilities of OBD-II/EOBD while navigating through menus without being connected to a vehicle.

## Start Communication

Use the following procedure to begin an OBD-II/EOBD test session:

**To perform an OBD-II/EOBD Test:**

1. Select **Start Communications** from the OBD-II/EOBD menu.

A vehicle type options list displays:

- 12V Light Duty Vehicle
- 24V Heavy Duty/Goods Vehicle

2. Select an option from the vehicle type list.

A connection message displays.

3. Connect the data cable to the test vehicle.

4. Select **Continue**.

The Diagnostic Tool establishes a communication link with the test vehicle, then displays an information screen that shows how many control modules were detected, which ECM is communicating, and which communication protocol is being used (Figure 5-4).



Figure 5-4 Protocol information screen

5. Select **Continue**.

A Select Service menu of available tests displays, options include:

- [Readiness Monitors](#), on page 47
- [MIL Status](#), on page 47
- [\(\\$01\) Display Current Data](#), on page 47
- [\(\\$02\) Display Freeze Frame Data](#), on page 48
- [\(\\$03\) Display Trouble Codes](#), on page 48
- [\(\\$04\) Clear Emissions Related Data](#), on page 48
- [\(\\$05, 06, 07\) Display Test param./Results](#), on page 49
- [\(\\$08\) Request Control of On-board System](#), on page 49
- [\(\\$09\) Read Vehicle Identification](#), on page 49
- [\(\\$0A\) Emission Related DTC with Permanent Status](#), on page 50

**IMPORTANT:**

All service modes are not supported by all vehicles, so the available menu selections will vary.

6. Select a test to continue.

**Readiness Monitors**

Use this menu item to check the readiness of the monitoring system. If a monitor system is not supported, it is not displayed. Scroll, if needed, to view the entire list of monitors (Figure 5-3). Selecting Readiness Monitors opens a submenu with two choices:

- **Monitors Complete Since DTC Cleared**—displays the results of all monitor tests that have run since the last time the electronic control module (ECM) memory was cleared.
- **Monitors Complete This Cycle**—displays only the results of monitor tests that ran during the current drive cycle, they reset when the ignition is switched off.

**MIL Status**

This item is used to check the current condition of the malfunction indicator lamp (MIL). Additional information, such as which ECM commanded the MIL on and the distance driven while the MIL is on (if supported), can also be displayed. It is also possible to save the MIL Status report.

**(\$01) Display Current Data**

Use this item to display the current emission related data from the selected electronic control module (ECM) of the vehicle. The main body of the screen has two columns; the left-hand column is a description of the parameter and the right-hand column is the parameter value or state.

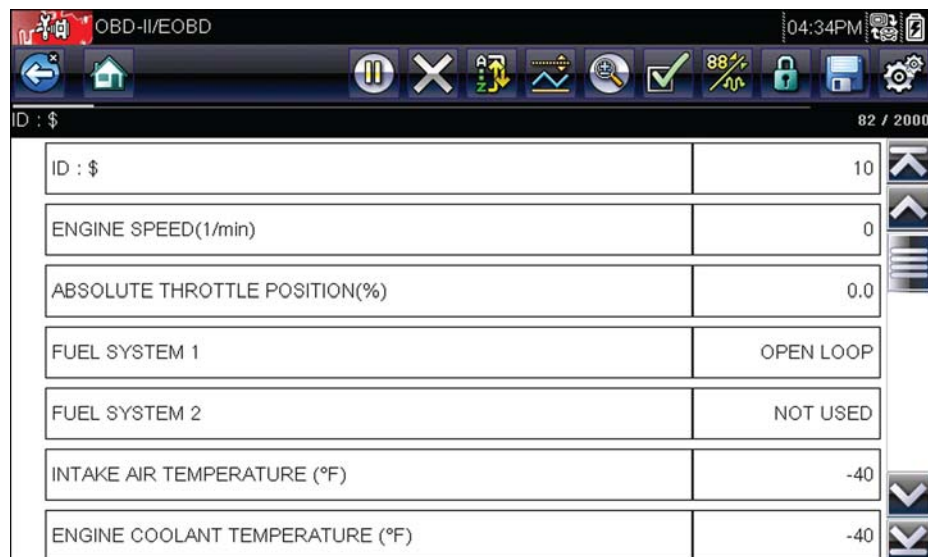

Figure 5-5 Current data display

### **(\$02) Display Freeze Frame Data**

Freeze frame data provides a “snapshot” of critical parameter values at the time a DTC set.

This item is used to display freeze frame data for any stored emission related diagnostic trouble code (DTC). In most cases the stored frame is the last DTC that occurred. Certain DTCs, those that have a greater impact on vehicle emission, have a higher priority. In these cases, the highest priority DTC is the one for which the freeze frame records are retained.

### **(\$03) Display Trouble Codes**

This is used to display any stored emission related DTCs reported by the ECM. The display is similar to a Scanner code display (see [Display Codes](#), on page 26 for details) The list does not include enhanced DTCs in this mode.

### **(\$04) Clear Emissions Related Data**

This item is used to clear all emission related diagnostic data, such as DTCs, freeze frame data, and test results, from the memory of the selected ECM.



#### **To clear emission related Data:**

1. Select Clear Emissions Related Data from the menu.

A confirmation message displays to help prevent loss of any vital data ([Figure 5-6](#)).

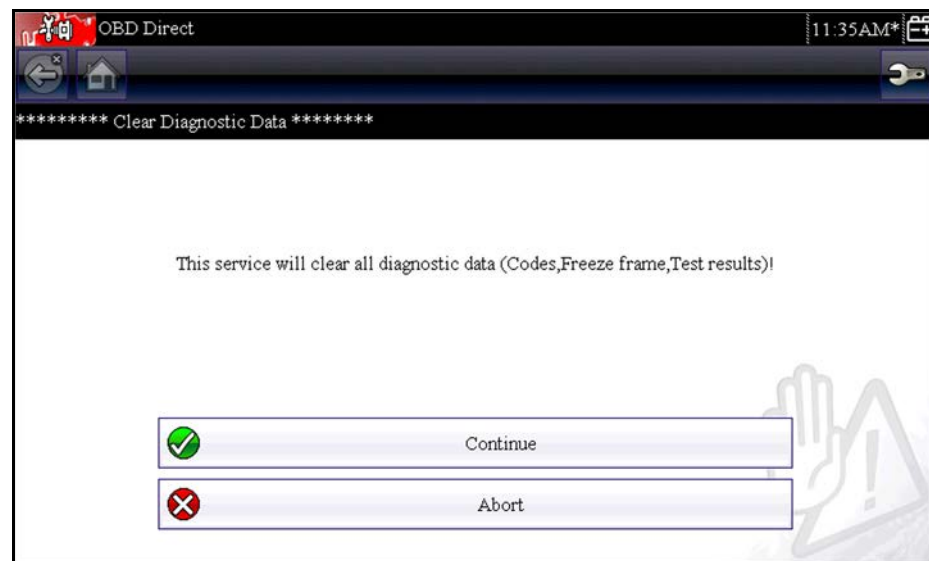

**Figure 5-6** Clear codes confirmation

2. Continue from the confirmation message.  
The screen updates several times as ECM memory is erased, then a “data has been cleared” message displays.
3. Select **Continue** to return to the Select Service menu.

***(\$05, 06, 07) Display Test param./Results***

This option opens a submenu of parameters and test results from various sensors, monitor test results, and a record of DTC setting conditions detected during the last drive cycle. The submenu includes:

- [\(\\$05\) Oxygen Sensor Monitoring](#)
- [\(\\$06\) Specific Monitored Systems](#)
- [\(\\$07\) DTCs Detected During Last Drive](#)

***(\$05) Oxygen Sensor Monitoring***

This option opens a menu of tests available for checking the integrity of the oxygen sensors. Making a selection displays all of the pertinent O2S parameters for the specific test. The test identification (ID) displays at the top of the data list.

***(\$06) Specific Monitored Systems***

This option opens a menu of available test results on monitored systems. The data available is for specific systems and components that the onboard diagnostic system either continuously monitors, such as misfire, or non-continuously monitors, such as the catalyst system. Making a selection displays the test results.

***(\$07) DTCs Detected During Last Drive***

This selection opens a record of any DTCs that set during the last completed drive cycle. Select to open the DTC list.

***(\$08) Request Control of On-board System***

This service enables bidirectional control of the ECM. The purpose of this service is to allow the Scanner to control the operation of an onboard system, test, or component. Select a test and follow the on-screen instructions.

***(\$09) Read Vehicle Identification***

The purpose of this service is to enable the Scanner to request and display vehicle-specific information, such as the vehicle identification number (VIN), the calibration identification, and the calibration verification number (CVN), of the test vehicle. Select a menu item to retrieve the information. Select **Return** to go back to the menu.

***(\$09) In-use Performance Tracking***

This option displays the "In-use Performance Tracking" of data. It is a record of the number of times each of the monitor tests have been completed. Select **Return** to go back to the menu.



Figure 5-7 Performance tracking display

### (\$0A) Emission Related DTC with Permanent Status

This option displays a record of any “permanent” codes. A permanent status DTC is one that was severe enough to illuminate the MIL at some point, but the MIL may not be on at the present time.

Whether the MIL was switched off by clearing codes or because the setting conditions did not repeat after a specified number of drive cycles, a record of the DTC is retained by the ECM. Permanent status codes automatically clear after repairs have been made and the related system monitor runs successfully.

### Connector Information

This option opens a database of vehicle diagnostic connector locations that includes most makes and models. The menu driven interface leads you quickly to difficult to find test connectors.



#### To locate a vehicle diagnostic connector:

1. Select **Connector Information** from the System menu.  
A list of vehicle manufacturers displays.
2. Select a manufacturer from the list.  
A list of models available from the selected manufacturer displays.
3. Select a model from the list.  
If a cable adapter is needed, which one and how to connect it displays.
4. Select **Continue**.  
Information on where to locate the vehicle diagnostic connector displays.
5. Select **Continue** to return to the System menu.

## Manual Protocol Selection

Communication protocol is a standardized way of transferring data between an ECM and a Diagnostic Tool. Global OBD may use the following communication protocols:

- ISO 15765-4 (CAN)
- ISO 27145 (WWHOBD CAN)
- ISO J1939 (CAN)
- ISO 9141-2 (K-LINE)
- SAE J1850 PWM (Pulse Width Modulation)
- SAE J1850 VPW (Variable Pulse Width)
- ISO 14230-4 (Keyword Protocol 2000)
- SAE J2284/ISO 15765-4 (CAN)

When initially attempting to establish communication with the ECM the Diagnostic Tool attempts to communicate trying each protocol in order to determine which one is being used. During normal operation the communication protocol is automatically detected. If automatic detection fails, communication protocol can be manually selected.

---

### IMPORTANT:

Using unsupported OBD communication protocols may activate warning lights and can set network related faults. Only use the manual selection option when OBD protocol is already known.

---

Select **Manual Protocol Selection** to open a menu of options (Figure 5-8).

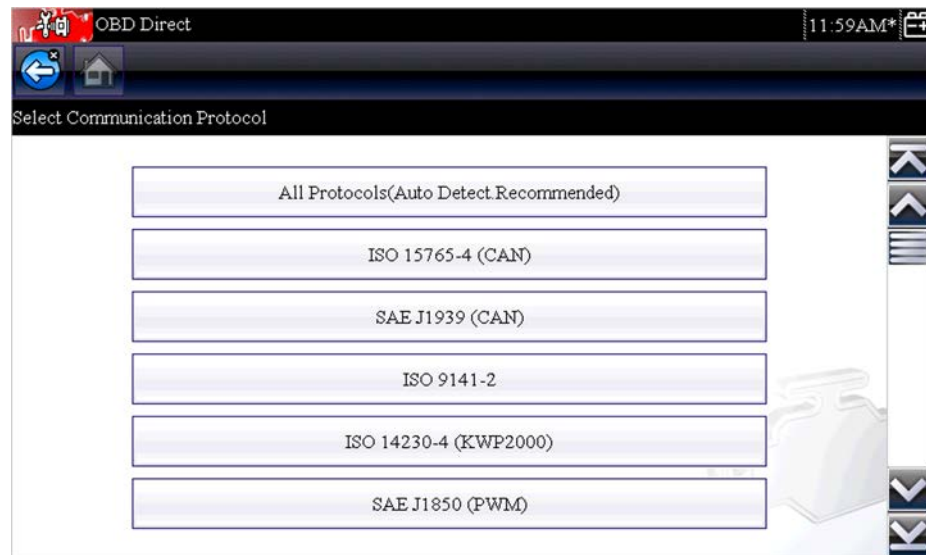

Figure 5-8 Manual protocol selection menu

Select the **Back** icon or press the **N/X** button to return to the OBD-II/EOBD Main menu.



This chapter describes the basic operation of the Previous Vehicles and Data function.



The **Previous Vehicles and Data** icon is located on the Home screen. This function allows you to select recently tested vehicles and access saved data files.

## 6.1 Previous Vehicles and Data Menu

The following options are available from the Previous Vehicles and Data menu:

- [Vehicle History](#)
- [View Saved Data](#), on page 53
- [Delete Saved Data](#), on page 55

### 6.1.1 Vehicle History

The Diagnostic Tool stores the identification of the last twenty-five vehicles tested, so there is no need to go through the complete vehicle identification sequence when performing a retest after repairs have been made. The oldest vehicle record is deleted when a new vehicle is identified once there are twenty-five vehicles on file.

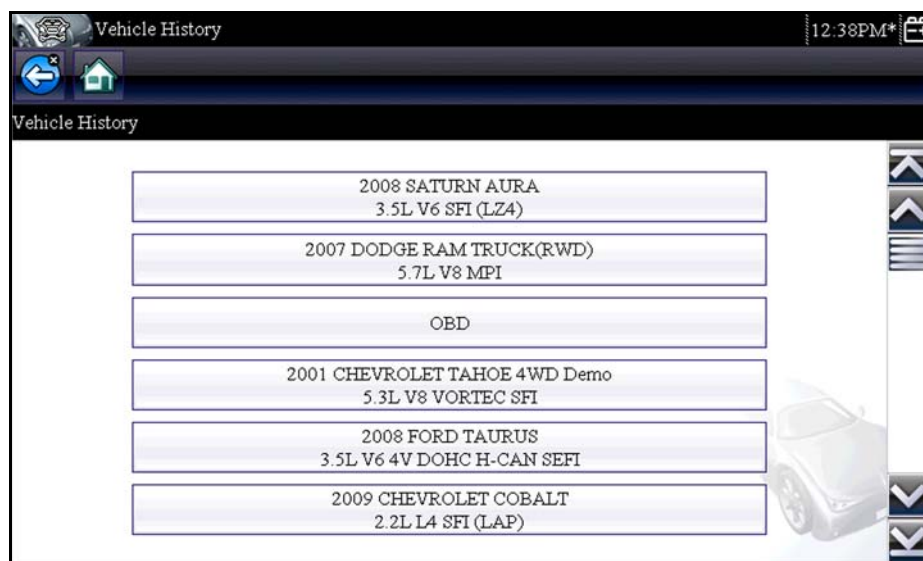

Figure 6-1 Vehicle history list



### To select from the vehicle History:

1. Select **Previous Vehicles and Data** from the Home screen.
2. Select **Vehicle History** from the menu.  
A list of up to 25 previously tested vehicles displays. Each vehicle is given a unique file name that includes the vehicle ID, date, and time. Use the scroll bar to view the entire list.
3. With the item to be opened highlighted, either tap the vehicle ID or press the **Y/✓** button.  
The appropriate software loads and a vehicle ID confirmation screen displays.
4. Select **OK** or press **Y/✓** to continue.  
A connection message displays.
5. Connect the data cable to the vehicle, then select **OK** or press **Y/✓** to continue.  
The menu for the last system tested on the selected vehicle displays.

## 6.1.2 View Saved Data

Selecting the **View Saved Data** menu option opens a list of all the data movies and screen images that are stored in the Diagnostic Tool memory. Saved files are listed in chronological order by the date and time that they were created with the most recent files are at the top of the list. The vehicle ID characteristics are included in the listings as well.



Figure 6-2 Saved data list

Saved files can either be opened directly on the Diagnostic Tool, or downloaded to a personal computer and opened using ShopStream Connect. See [Saving and Reviewing Scanner / OBD-II/EOBD Data Files](#), on page 36 and [Connect to PC](#), on page 57 for additional information.



### NOTE:

A maximum of 50 files are displayed. To view all (if more than 50) files stored, use ShopStream Connect. See [Connect to PC](#), on page 57 for additional information.

**To review a movie:**

1. Select **Previous Vehicles and Data** from the Home screen.
2. Select **View Saved Data** from the menu.
3. Select a movie from the list of saved files.

The movie opens and plays in real time. The **Play** icon changes to the **Pause** icon at the end of the movie.

## Movie reviewing tips:

- The **Pause/Play** and **Graph** toolbar icons are active while a movie is playing, so you can stop the movie or switch between list and graph view at any time.
- The **Previous Frame** and **Next Frame** icons are active if the data is paused.

**Viewing Codes and Code Scan Results**

When code scan or single system code results are saved, they are saved in (.XML) file format (Figure 6-3).



Figure 6-3 Typical - Code Results (.XML) file

The saved (.XML) file(s) can be viewed using these methods:

- On the diagnostic tool - See [Viewing Code Results on the Diagnostic Tool](#), on page 55.

In report format using:

- ShopStream Connect - see [Printing the Code Scan Report](#), on page 73.

### Viewing Code Results on the Diagnostic Tool

Selecting a system code or a code scan results file from your saved file list (Figure 6-4), opens the file onscreen. When opened, the (.XML) file displays basic vehicle information and a list of DTCs with a brief description of each.

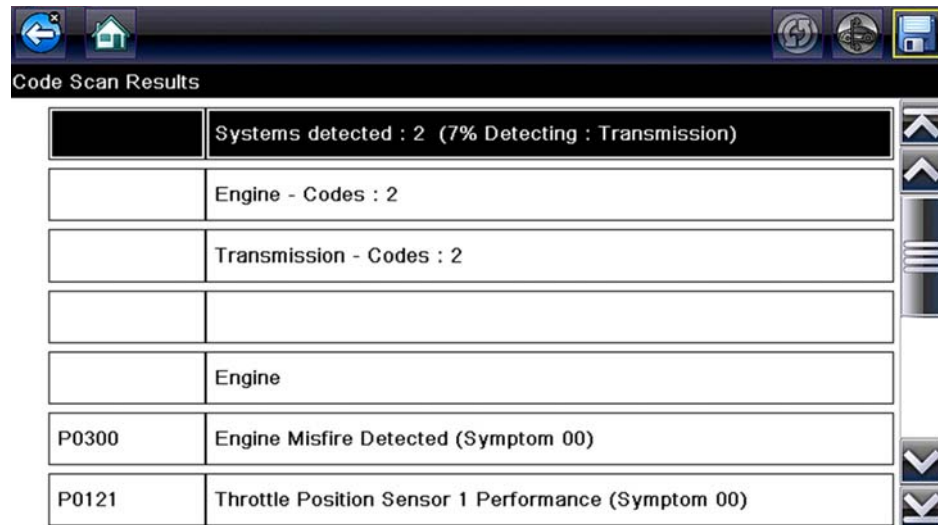

Figure 6-4 Typical - Code Scan Results (.XML file) viewed onscreen

## 6.1.3 Delete Saved Data

This menu option is used to permanently erase saved files from Diagnostic Tool memory when they are no longer needed.

### To delete a saved file:

1. Select **Previous Vehicles and Data** from the Home screen.
2. Select **Delete Saved Data** from the menu.  
A list of saved files displays.



#### NOTE:

The Select/Deselect and Select All/Deselect All icons become available on the toolbar so that you can either delete individual files or clear the entire memory buffer all at once.

3. Select a file from the list and a confirmation message displays.
4. Select an option from the confirmation message:
  - **OK**—deletes the selected file and returns to the saved files list, which no longer includes the deleted file.
  - **Cancel**—returns to the saved files list without deleting the selected file.
5. Select **Back** on the toolbar to return to the Previous Vehicles and Data menu, select **Home** to return to the Home screen.

This chapter describes the basic operation of the Tools function.



The **Tools** icon is located on the Home screen. This function allows you to configure Diagnostic Tool settings to your preferences.

## 7.1 Tools Menu

The following options are available from the Tools menu:

- [Connect to PC](#)—use to transfer and share files with a personal computer (PC)
- [Configure Shortcut Button](#), on page 57—use to change the function of the shortcut button
- [System Information](#), on page 58—use to view configuration information for the Diagnostic Tool
- [Settings](#), on page 58—use to configure certain characteristics of the Diagnostic Tool



Figure 7-1 Tools menu

## 7.1.1 Connect to PC

**Connect-to-PC** allows you to transfer saved data files on your diagnostic tool to your personal computer using a USB cable.

The optional ShopStream Connect™ PC software allows you to view, print and save data files on your PC. In addition, you can download software updates from the PC to the diagnostic tool. These features provide an ideal way to manage saved data files. The ShopStream Connect application is available free online, see [ShopStream Connect](#), on page 69 for additional information.



### To connect the diagnostic tool to a PC:

1. Connect the supplied USB cable to the diagnostic tool and then to the PC.  
A USB cable, supplied with your diagnostic tool, is used to connect the diagnostic tool to the PC. When the diagnostic tool is connected to the PC a communications icon appears on the right edge of the title bar.
2. Select **Tools** from the Home screen.
3. Select **Connect-to-PC** from the Tools and Setup menu.

A screen message will display to confirm the tool is in Connect-to-PC-mode.

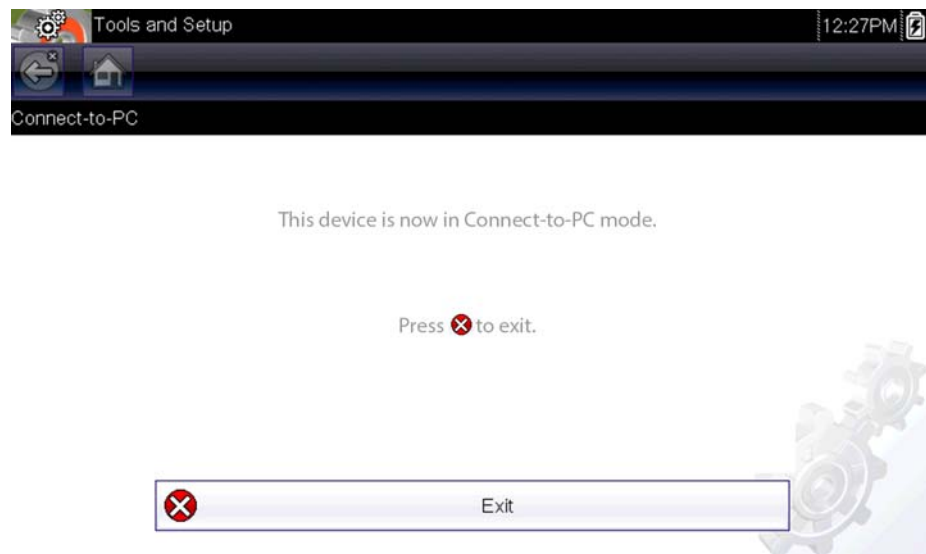

Figure 7-2

## 7.1.2 Configure Shortcut Button

This feature allows you to change the functionality of the **Shortcut** button. Options are:

- **Brightness**—increases the screen backlighting in incremental steps from lowest to highest, then returns to the lowest setting and continuously repeats.
- **Save Screen**—takes a snapshot of the current screen. A snapshot includes the visible screen only, and is saved as a graphic image.
- **Save Movie**—saves a recording of vehicle data (buffered data plus data transmitted after triggering) in Diagnostic Tool memory.
- **Show Shortcut Menu**—opens the Configure Shortcuts menu when the Shortcut button is pressed so you can quickly select from any of the available functions.

- **Toggle Record/Pause**—programs the Shortcut button to work as the Pause and Record buttons. The first press pauses data collection and the second press resumes live data.



#### To assign a function to the Shortcut button:

1. Select **Tools** from the Home screen.  
The Tools menu opens.
2. Select **Configure Shortcut button** from the menu.
3. Select a function from the menu.
4. Select the **Back** on the toolbar or press the **N/X** button to return to the options menu.

## 7.1.3 System Information

The **System Information** option lets you view configuration information for your Diagnostic Tool.



#### To display the System information screen:

1. Select **Tools** from the Home screen to open the menu.
2. Select **System Information** from the menu.  
The System Information screen displays.



Figure 7-3 System information screen

3. Select **Back** on the toolbar or press the **N/X** button to return to the options menu.

## 7.1.4 Settings

This Tools selection allows you to adjust certain basic diagnostic tool functions to your personal preferences. Selecting opens an additional menu that offers the following:

- [System Settings](#), on page 59
- [Configure Scanner](#), on page 64
- [Configure Units](#), on page 65

## System Settings

Selecting System Settings opens a menu with two options; Display and Date & Time. Either selection opens an additional menu.

Display options include:

- [Brightness](#), on page 59—adjusts the intensity of the screen back lighting.
- [Color Theme](#), on page 60—changes the background color of the screen display.
- [High Contrast Toolbar](#), on page 60—enhances toolbar graphics for poor lighting conditions.
- [Font Type](#), on page 61—switches between standard and bold text for better visibility.
- [Backlight Time](#), on page 61—adjusts how long the screen stays on with an idle unit.
- [Touch Calibration](#), on page 61—calibrates the touch screen display.

Date & Time options include:

- [Time Zone](#), on page 62—sets the internal clock to the local time standard.
- [Clock Settings](#), on page 62—sets the time on the internal clock.
- [Daylight Savings Time](#), on page 63—configures the clock for Daylight Savings Time.
- [Time Format](#), on page 63—switches the time displays between a 12 or 24 hour clock.
- [Date Format](#), on page 64—configures how the month, date, and year displays.

### Brightness

Selecting this option opens the brightness setting screen for adjusting the back lighting of the display ([Figure 7-4](#)).

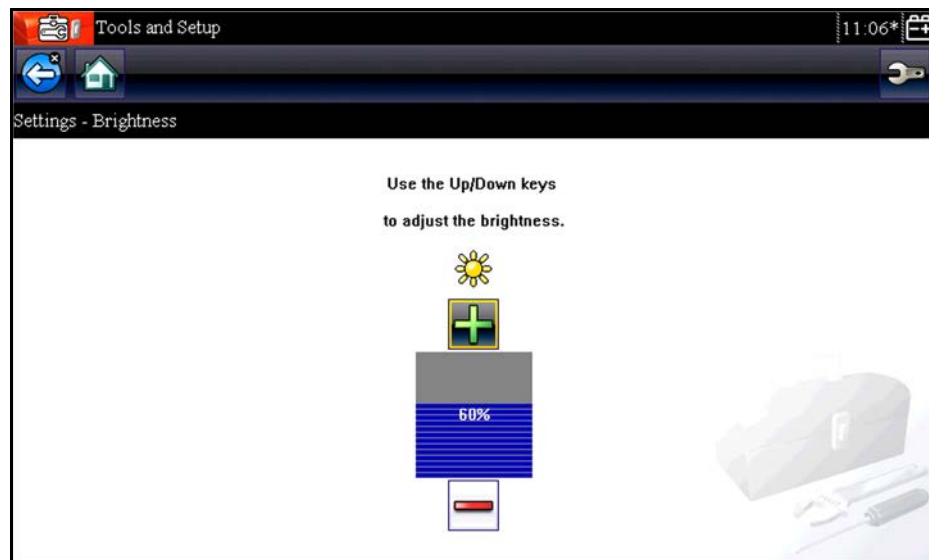

Figure 7-4 Brightness setting screen

Each tap of the **Plus** and **Minus** icons, or the up (▲) and down (▼) arrows, incrementally changes the back lighting up or down respectively.

Select **Back** from the toolbar or press the **N/X** button to exit.



### Color Theme

This option allows you to select between a white and black background for the screen. The black background can be beneficial when working under poor lighting conditions.

Selecting opens a menu with two choices: **Day Theme** (white background) and **Night Theme** (black background). Make a selection and a “please wait” message momentarily displays followed by the Home screen. The new toolbar setting is now active.

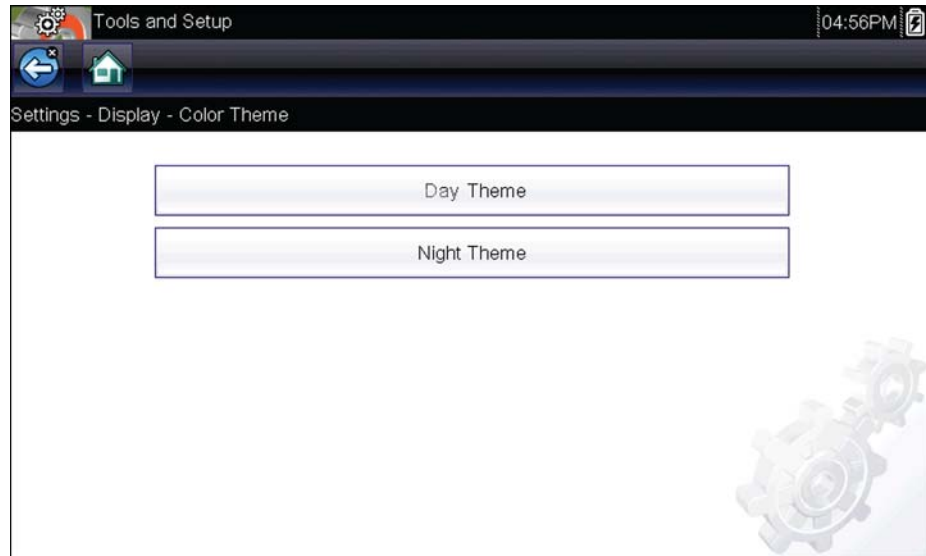

Figure 7-5 Theme menu screen

### High Contrast Toolbar

This option allows you to switch to a high contrast toolbar. This toolbar features black and white icons with crisp graphics that are easier to see in poor lighting conditions or bright sunlight.

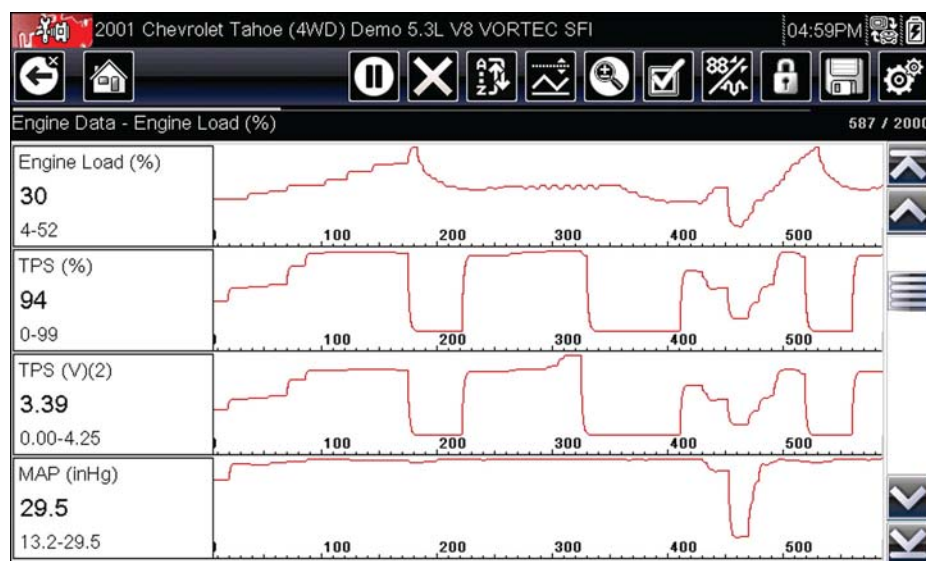

Figure 7-6 High-contrast toolbar

Selecting opens a menu with two choices; Color Toolbar and High Contrast Toolbar. Select and a “please wait” message displays followed by the Home screen. The new setting is now active.

### **Font Type**

This option allows you to select between standard and bold faced type for the display screen. Bold type makes screen writing more legible under poor lighting or bright sunlight conditions.

Selecting opens a menu with two choices: Normal Font and Bold Font. Tap a menu item, or scroll with the keypad and Press **Y/✓**, to make a selection. The change is instantaneous. Select the Back or Home icon on the toolbar to return to either the Settings menu or the Home screen.

### **Backlight Time**

This option allows you to configure how long the screen backlight remains on when the tool is inactive. The following choices are available:

- Always On
- 15 Seconds
- 30 Seconds
- 45 Seconds
- 60 Seconds

Tap the menu item desired, or scroll with the keypad and Press **Y/✓**, to make a selection. Select **Back** or **Home** on the toolbar to return to either the Settings menu or the Home screen.

### **Touch Calibration**

Calibrating the touch screen maintains the accuracy of the touch-sensitive display. Perform the following procedure on a routine basis to keep your diagnostic tool in good working order.



#### **To calibrate the touch screen:**

1. Select **Tools** from the Home screen to open the menu.
2. Select **Settings** from the menu.
3. Select **Touch Calibration** from the menu.

The calibration screen opens ([Figure 7-7](#)).

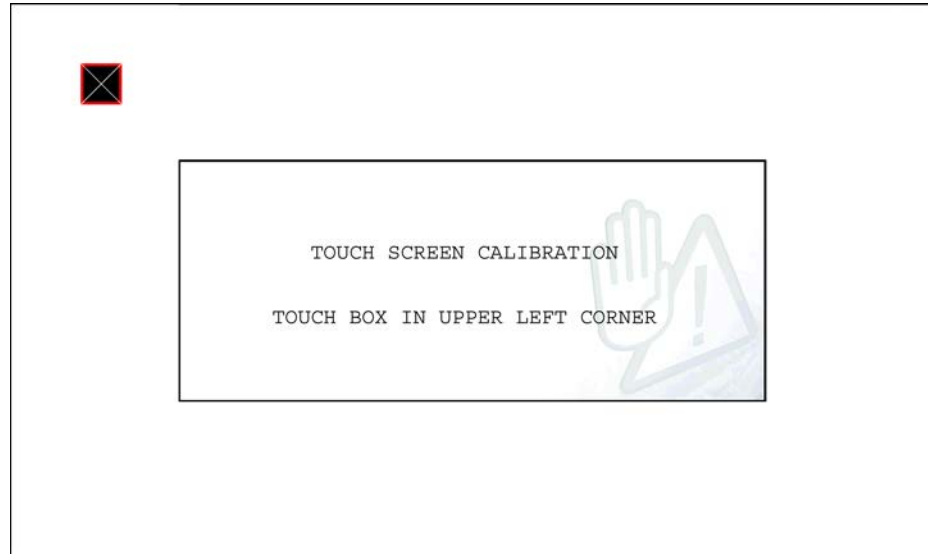

Figure 7-7 Calibration screen

4. Touch each box on the screen as it displays.  
The display returns to the Settings menu once the screen calibration procedure is complete.

---

**IMPORTANT:**

It is critical to complete the touch screen calibration sequence once it has begun. Never power down the unit while a screen calibration is in process, serious damage to the unit may result.

---

***Time Zone***

This option opens a menu of time zone settings. Scroll to highlight, then select the local time zone. The display returns to the Settings menu once a time zone is selected.

***Clock Settings***

This option opens a window for resetting the time on the real-time clock.



**To set the clock:**

1. Select **Tools** from the Home screen to open the menu.
2. Select **Settings** from the menu.
3. Select **Clock Settings** from the menu.

A warning message briefly displays followed by the Clock Settings screen ([Figure 7-8](#)).

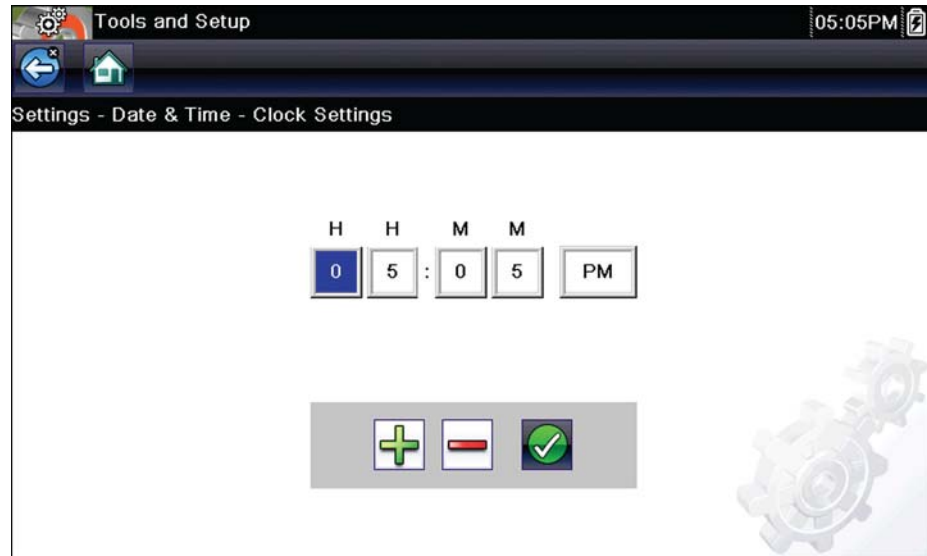

Figure 7-8 Clock Settings screen

4. Tap the **up (+)** icon on the screen or press the **up (▲)** button on the keypad to incrementally increase the number in the highlighted field. Tap the **down (-)** icon on the screen or press down (▼) on the keypad to incrementally decrease the number.
5. Tap the **check (✓)** icon on the screen or press the **Y/✓** button on the keypad to move the highlight to the next field.
6. Repeat Step 4 and Step 5 until the correct time is displayed.
7. Tap the **Back** on the toolbar or press the **Y/✓** on the keypad to close the Clock Settings window and return to the Settings menu.

### ***Daylight Savings Time***

This option opens a menu to configure the internal clock for Daylight Savings Time. Choose from:

- **ON**—sets the clock for Daylight Savings time.
- **OFF**—sets the clock for standard time.

Make either selection, then tap the **Back** icon or press the **N/X** button to return to the menu.

### ***Time Format***

This option determines whether time is displayed on a 12 or 24 hour clock. Selecting opens a menu with two choices:

- **24 Hour Format**
- **12 Hour Format**

Make either selection, then tap the **Back** icon or press the **N/X** button to return to the menu.

### Date Format

This option allows you to select how date information is displayed. Select from:

- **(MM\_DD\_YYYY)**—Month, Day, Year
- **(DD\_MM\_YYYY)**—Day, Month, Year
- **(YYYY\_MM\_DD)**—Year, Month, Day

Make a selection, then tap the **Back** icon or press the **N/X** button to return to the menu.

### Configure Scanner

This option determines whether or not the scales are displayed on the data graphs when using the Scanner. Scales are the graduations and values that display on the horizontal axis at the base of the parameter graphs. The waveform to fill the entire graph area with scales switched off.

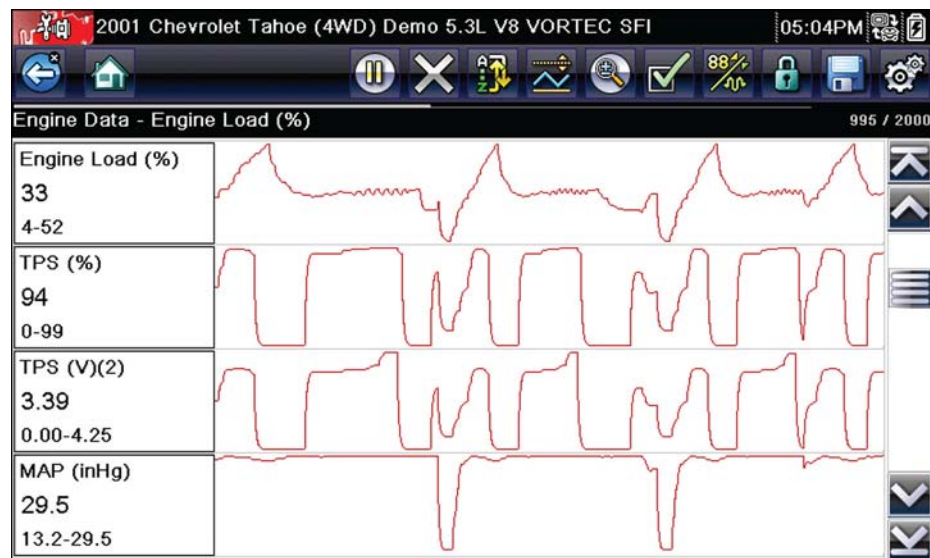

Figure 7-9 Scanner screen with scales hidden



#### To switch scanner scales:

1. Select **Tools** from the Home screen.
2. Select **Settings** from the Tools and Setup menu.
3. Select **Configure Scanner** from the Settings menu.
4. Highlight either menu entry to make a selection:
  - **Show Graph Scale**—to switch the scales on.
  - **Hide Graph Scale**—to switch the scales off.
5. Tap the **Back** icon or press the **N/X** button to return to the Settings menu.

## Configure Units

Selecting opens a dialog box that allows you to choose between US customary or metric units of measure for temperature, vehicle speed, air pressure, and other pressures.



Figure 7-10 *Configure Units menu*



### To change the units setup:

1. Select **Tools** from the Home screen to open the menu.
2. Select **Configure Units** to open the menu.
3. Select an item from the Configure Units menu.
  - Temperature
  - Vehicle Speed
  - Pressure, Air (Scanner)
  - Pressure, Other (Scanner)
4. Select a setting from the listed choices.
5. Select **Back** on the toolbar or press the **N/X** button to return to the options menu.

This chapter covers how to care for your Diagnostic Tool.

## 8.1 Cleaning and Inspecting the Diagnostic Tool

When using the Diagnostic Tool perform the following tasks to keep it in top shape:

- Check the housing, wiring, and connectors for dirt and damage before and after each use.
- At the end of each work day, wipe the Diagnostic Tool housing, wiring, and connectors clean with a damp cloth.

---

**IMPORTANT:**

Do not use any abrasive cleansers or automotive chemicals on the unit.

---

### 8.1.1 Cleaning the Touch Screen

The touch screen can be cleaned with a soft cloth and a mild window cleaner.

---

**IMPORTANT:**

Do not use any abrasive cleansers or automotive chemicals on the touch screen.

---

## 8.2 Battery Service

Follow all safety guidelines when handling the battery pack.

**⚠ WARNING**

Risk of electric shock.

- **Prior to recycling the battery pack, protect exposed terminals with heavy insulating tape to prevent shorting.**
- **Disconnect all test leads and turn diagnostic tools off before removing the battery pack.**
- **Do not attempt to disassemble the battery pack or remove any component projecting from or protecting the battery terminals.**
- **Do not expose the unit or battery pack to rain, snow, or wet conditions.**
- **Do not short circuit the battery terminals.**

*Electric shock can cause injury.*

**⚠ WARNING**

Risk of explosion.

- **Use the proper factory lithium battery pack only, incorrect replacement or tampering with the battery pack may cause an explosion.**

*Explosion can cause death or serious injury.*

## 8.2.1 Battery Safety Guidelines

---

**IMPORTANT:**

The battery pack contains no user serviceable components. Tampering with the battery pack terminals or housing will void the product warranty.

---

Keep the following in mind when using and handling the battery pack:

- Do not short circuit battery terminals.
- Do not immerse the Diagnostic Tool or battery pack in water, or allow water to enter the unit or battery compartment.
- Do not crush, disassemble, or tamper with the battery pack.
- Do not heat the battery pack to over 100°C (212°F), or dispose of it in a fire.
- Do not expose the battery pack to excessive physical shock or vibration.
- Keep the battery pack out of reach of children.
- Do not use a battery pack that appears to have suffered abuse or damage.
- Store the battery pack in a cool, dry, well ventilated area.

---

**NOTE:**

The battery pack should be used within a short period of time (about 30 days) after charging to prevent loss of capacity due to self-discharging.

---

If long-term storage of the battery pack is necessary, it should be stored in a cool, dry, well ventilated place with a 30 to 75 percent state of charge to prevent loss of characteristics.

To prolong the life of your battery, power off the unit when not in use. The Diagnostic Tool has a built in charger that recharges the battery on demand whenever it is connected to a power source.

## 8.2.2 Replacing the Battery Pack

If the battery pack no longer holds a charge, contact your sales representative to order a new one.

---

**IMPORTANT:**

Replace the battery pack with original Snap-on replacement parts only.

---

**To replace the battery pack:**

1. Loosen the two captive screws that secure the battery pack to the back of the unit.
2. Lift up and tilt to raise the battery cover from the Diagnostic Tool housing.
3. Slide the battery pack to the left to disconnect the contacts, then lift it clear of the unit.
4. Position the new battery pack and slide it into position in the battery compartment.
5. Make sure the battery pack is fully seated.
6. Fit the battery cover.
7. Tighten the two captive screws.



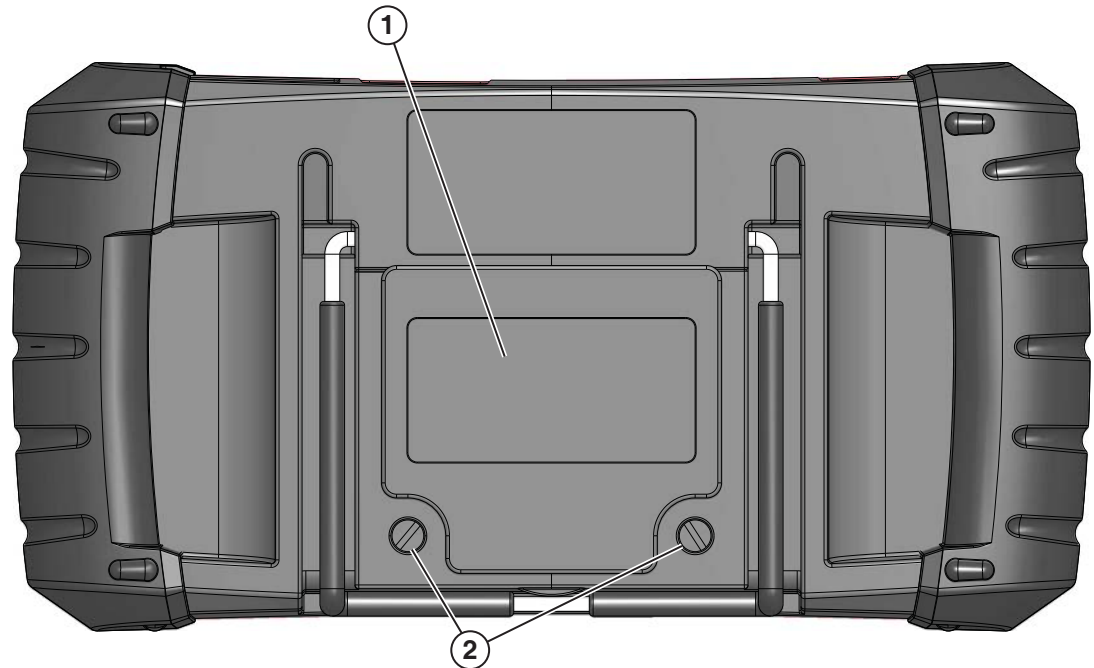

- 1— Battery Cover  
2— Captive Screws

Figure 8-1 Battery pack replacement

### 8.2.3 Disposing of the Batteries

Always dispose of a lithium-ion battery pack according to local regulations, which vary for different countries and regions. The battery pack, while non-hazardous waste, does contain recyclable materials. If shipping is required, ship the battery pack to a recycling facility in accordance with local, national, and international regulations.

- For additional information within the United States of America contact: Rechargeable Battery Recycling Corporation (RBRC) at [www.call2recycle.org](http://www.call2recycle.org) Phone - 800 822-8837
- For additional information within Canada contact: Rechargeable Battery Recycling Corporation (RBRC) at [www.call2recycle.ca](http://www.call2recycle.ca) Phone - 888 224 9764

Products bearing the WEEE logo (Figure 8-2) are subject to European Union regulations.



Figure 8-2 WEEE logo



**NOTE:**

Always dispose of materials according to local regulations.

Contact your sales representative for details.

This chapter includes a brief introduction to some of the key features of the ShopStream Connect software. For detailed ShopStream Connect information and instructions, download the ShopStream Connect User Manual from our website: <http://diagnostics.snapon.com/usermanuals>

The ShopStream Connect™ (SSC) software is PC-based software that extends the capabilities of your diagnostic tool. Using ShopStream Connect software with your diagnostic tool allows you to do the following:

- View, Print, and Manage data saved from your Diagnostic tool.
- Move and copy your data between the diagnostic tool and your PC.
- View and Print trouble codes saved with select diagnostic tools. This allows you to share the data in a report format with vehicle owners or other technicians.
- Add or edit notes and comments to diagnostic tool data files.
- Download and install diagnostic tool software updates and upgrades.

The ShopStream Connect (SSC) software is available (free of charge) at:

**ShopStream Connect** - <http://diagnostics.snapon.com/ssc>

## 9.1 Using SSC (Connecting to your PC)



**To connect and use SSC with your diagnostic tool:**

1. Download and install SSC on your PC from: <http://diagnostics.snapon.com/ssc>
2. Turn your diagnostic tool on.
3. Connect the supplied USB cable from the USB jack on your diagnostic tool to your PC:
4. From the diagnostic tool Home screen, select **Tools > Connect-to-PC**.

The “**Device is now in Connect-to-PC mode**” screen message is displayed (Figure 9-1) and the ShopStream Connect software will open automatically on your PC (Figure 9-2).

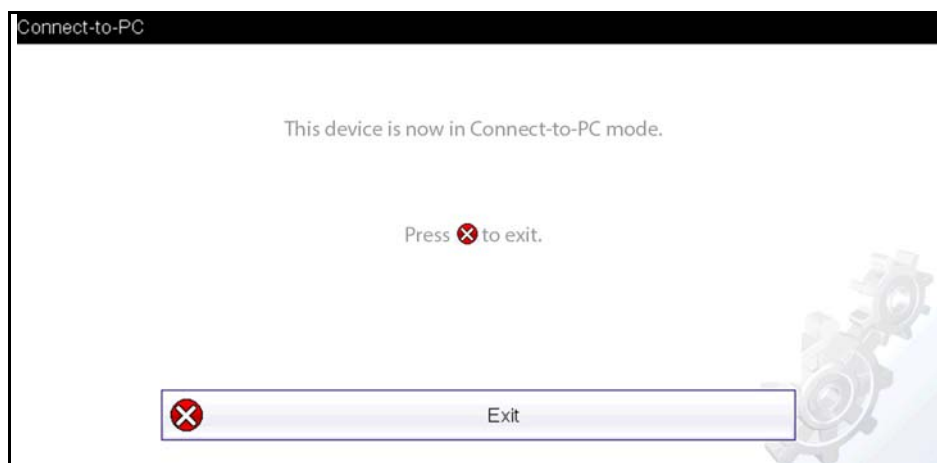

Figure 9-1

If the ShopStream Connect software does not open, open it from the Windows Start menu or use the ShopStream Connect shortcut icon on the Windows desktop (automatically created during installation).

## 9.2 SSC Main Screen

The ShopStream Connect software will open automatically when you connect the diagnostic tool to your PC USB connection, [Using SSC \(Connecting to your PC\)](#), on page 69,.

The following shows the main screen layout for ShopStream Connect software.

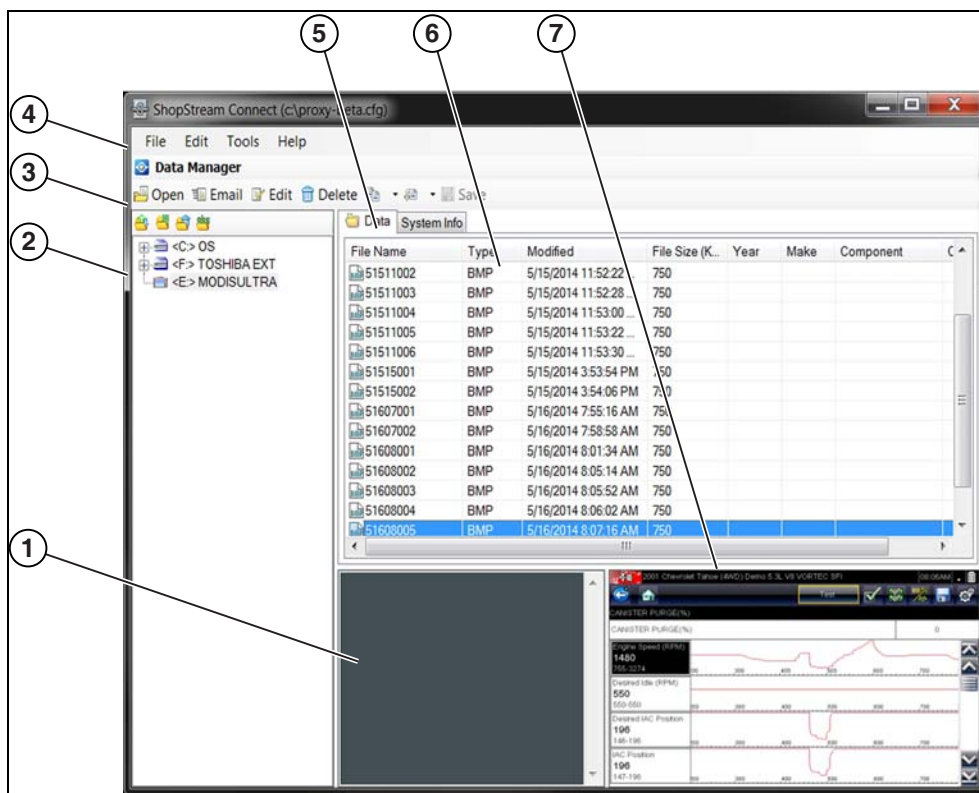

Figure 9-2

- 1— **Notes Window**—allows you add notes to select data files. Select Save from the menu bar to save your notes. *NOTE: Not all file types allow notes, the Notes window will be grayed out when a file type that does not support notes is highlighted. Some image files may display notes for reference purposes (the notes are grayed out and not editable).*
- 2— **File directory structure**—displays the file directory structure of your PC in standard Windows format, and shows any connected diagnostic tools at the bottom of the data list.
- 3— **Data Manager Toolbar**—provides control icons that perform a variety of operations on data files.
- 4— **Main Menu bar**—contains **File**, **Edit**, **Tools**, and **Help** menus.
- 5— **Tabs**—provides access to data files and presets stored on the diagnostic tool or on the PC, and also allows viewing of software revision details of the diagnostic tool.

- 6— **Main display**—shows stored data files details. *NOTE: The files listed are sortable (ascending/descending) by clicking on the column tab at the top (e.g. File Name, Type, etc.) Sort preferences are saved when the ShopStream Connect program is closed.*
- 7— **Preview**—displays a sample of the file if the selected file is a image file.

### 9.3 Scanner DataViewer

SSC allows you to view data files recorded with your diagnostic tool, on your PC. When a Scanner data file is selected, it opens and displays in the Scanner DataViewer (Figure 9-3). Scanner DataViewer allows you play the data file and custom configure the data in a number of ways.



- 1— Menu bar
- 2— Display toolbar
- 3— Graph display
- 4— Properties icon
- 5— Vertical Scroll bar
- 6— Zoom controls
- 7— Slider bar
- 8— Navigation toolbar
- 9— Parameter text list
- 10— Highlighted PIDs - indicates graphs currently displayed
- 11— Parameter configuration tabs

Figure 9-3

## 9.4 Image Viewer

SSC allows you to view and print .bmp, .jpg and .sps image files (screenshots) saved on your diagnostic tool, with your PC.

**NOTE:**

File extension types vary depending on the diagnostic tool. Not all the file extensions described here may be available on your diagnostic tool.

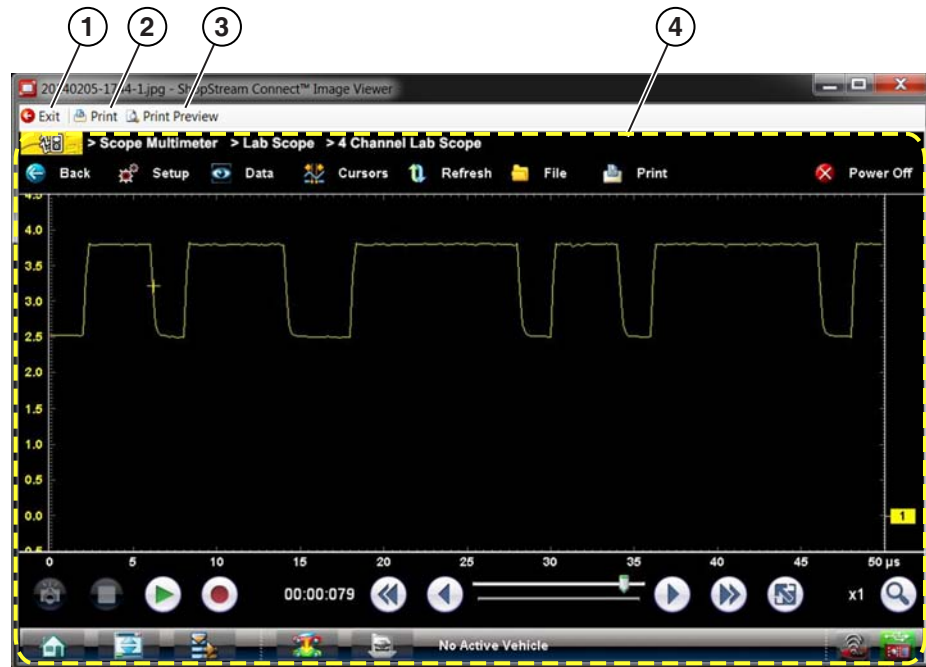

**1— Exit** - closes the Image Viewer  
**2— Print** - prints the image

**3— Print Preview** - allows the image to be previewed before printing  
**4— Captured Screen Image**

Figure 9-4

## 9.5 Printing the Code Scan Report

To print the Code Scan Report, the saved code scan .XML file must be opened using ShopStream Connect.

**To print the Code Scan Report using ShopStream Connect:**

1. Double-click the code scan .XML file from the file list to open the report (Figure 9-5) in the Code Scan Viewer (Figure 9-6).

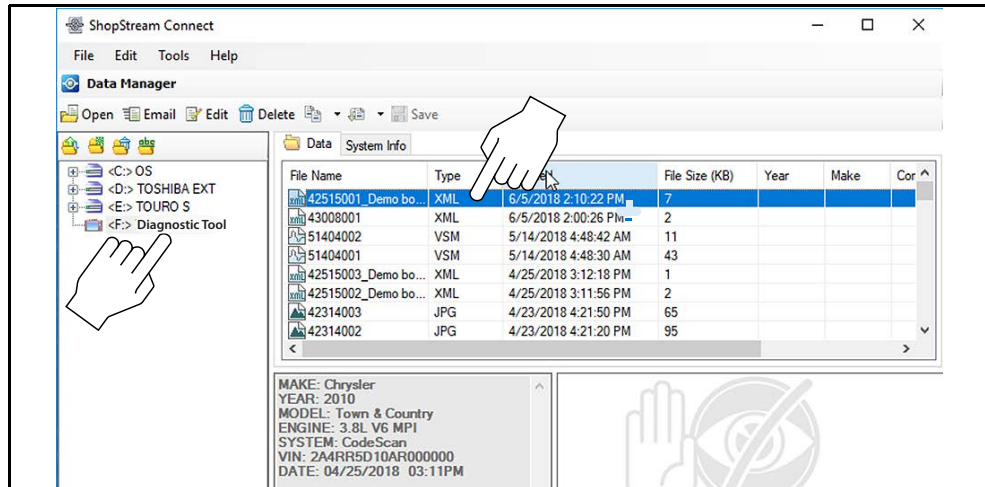

Figure 9-5

2. Select **Print** or **Print Preview** from the Code Scan Viewer menu to print or preview the report (Figure 9-6).

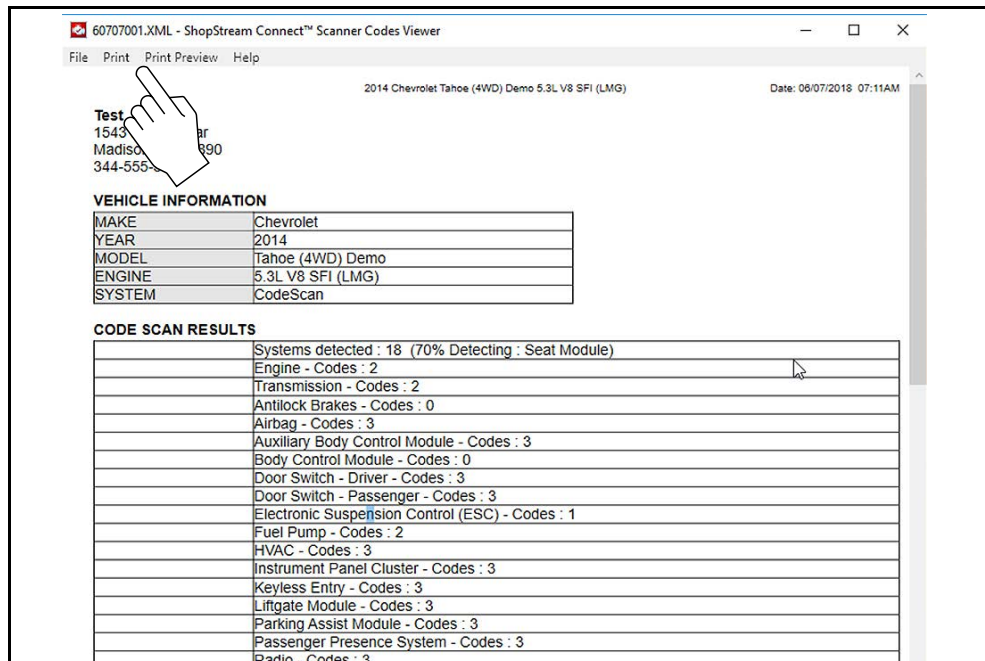

Figure 9-6

Selecting **Print** opens the Windows print dialog window (Figure 9-7). Select your printer from the list, then select **Print** to print the report.

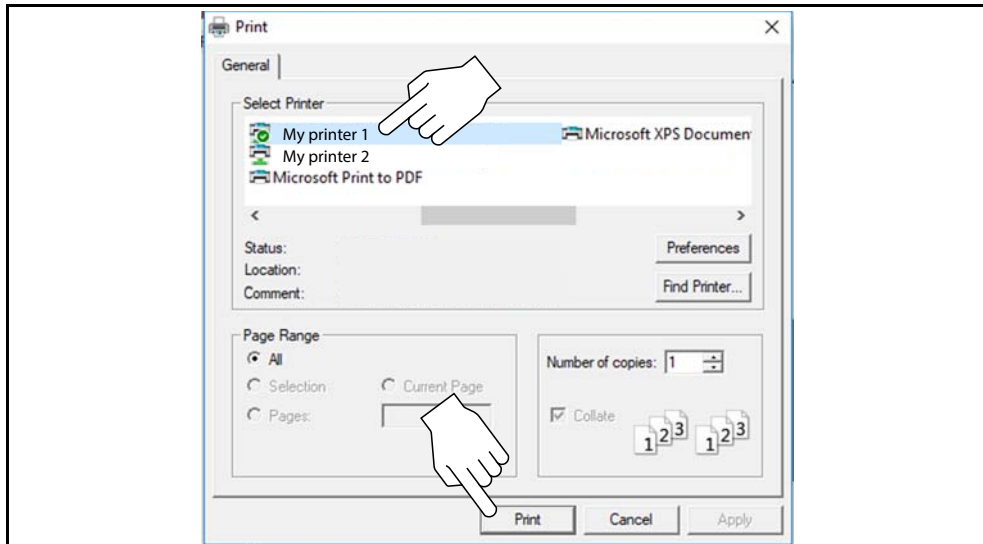

Figure 9-7

## 9.6 Software Upgrades and Updates

Upgrade/Update Descriptions:

- **Software Upgrade** - a software upgrade is a new software version (contact your sales representative for purchase information).
- **Software Update** - a software update is a service release for installed software. These are available free of charge, and are provided as necessary to update installed software. When your diagnostic tool is connected to a PC using SSC, the SSC software will automatically check for updates, and if an update is available, it will provide installation instructions. Follow the screen prompts to accept, download and install the software.



**NOTE:**

To receive updates or upgrades, SSC software must be installed on your PC and have connection to the Internet.



**Example - Updating diagnostic tool software:**

1. Select **Tools > Update Software > (diagnostic tool type - e.g. ETHOS Edge, MODIS Edge, SOLUS Edge, etc.)** from the Menu bar (Figure 9-8).  
The software checks the Snap-on web server for available updates.

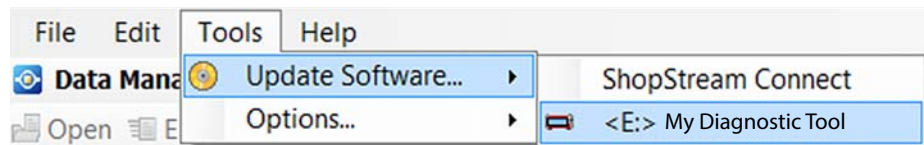

Figure 9-8

2. If service release updates are available, select **Next** to continue, then select **Download** and follow the on-screen instructions to complete the installation (Figure 9-9).

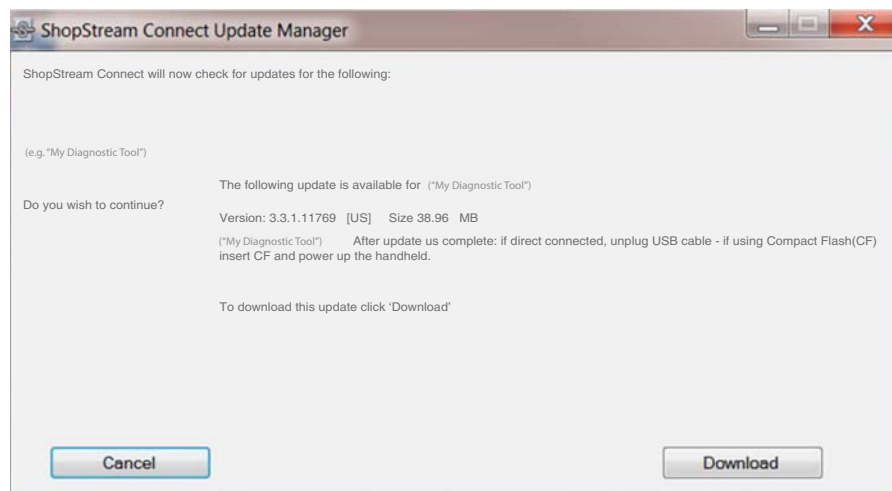

Figure 9-9



**NOTE:**

For additional information on ShopStream Connect software updates and upgrades, download the ShopStream Connect User Manual from our website: <http://diagnostics.snapon.com/usermanuals>



### 9.6.1 End User License Agreement

Before software installation at initial purchase, and before all subsequent software updates/ upgrades installations End User License Agreement (EULA) acceptance is required.

**IMPORTANT:**

Use of Software is governed by the terms and conditions of the End User License Agreement. The diagnostic tool should not be initially operated until the End User License Agreement is read. Use of the device acknowledges your acceptance of the End User License Agreement. The Snap-on Incorporated Software End User License Agreement is available at: <https://eula.snapon.com/diagnostics>

**To Accept:** at the screen prompt (Figure 9-10) click the checkbox on the left side of the window, and then select **Agree and Continue**. The software will be installed automatically.

Figure 9-10 below represents a typical EULA acceptance agreement screen.

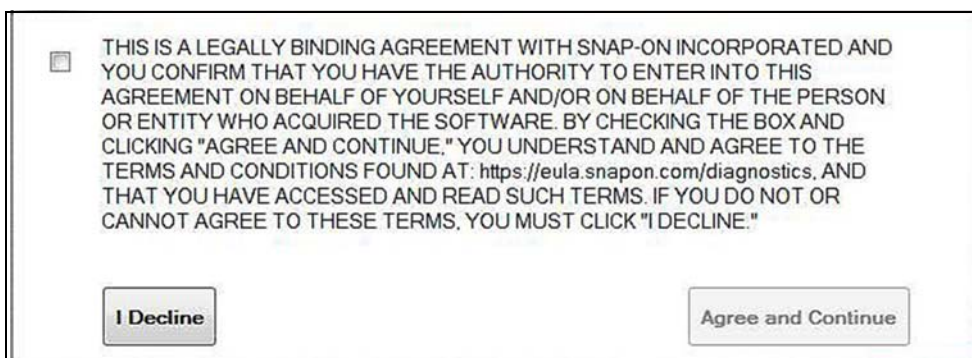

Figure 9-10 Typical EULA acceptance screen

**To Decline:** at the screen prompt (Figure 9-10) select **I Decline**. A confirmation message is displayed providing options to Go Back or Exit the software installation (Figure 9-11).

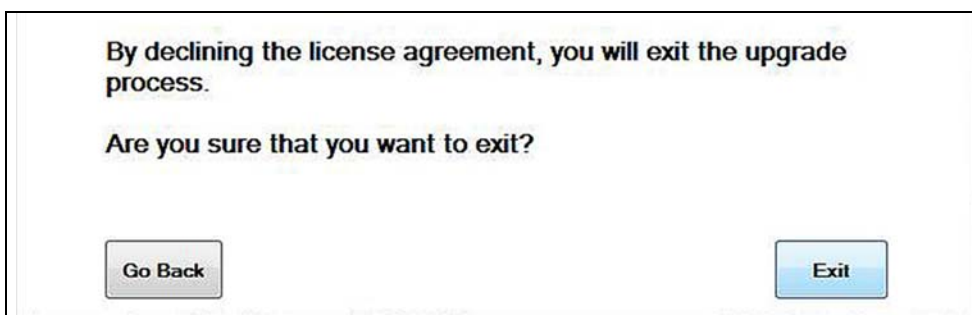

Figure 9-11 Typical EULA acceptance screen

## 10.1 SureTrack - Online Community

Your diagnostic tool includes access to the online SureTrack Community. You can use your PC to access the latest Real Fixes, Related Tips, and Common Repair Procedures information.

SureTrack is an evolving database of "real-world" automotive repair knowledge based on expert knowledge and millions of actual repair orders. It was designed to help you improve diagnostic accuracy and reduce repair times.

### 10.1.1 Main Topic Links

- [Finding your SureTrack Authorization Code](#) page 78
- [Creating a SureTrack Account](#) page 79
- [Logging In \(active account\)](#) page 83
- [Logging In with New Authorization Code \(active account\)](#) page 84
- [SureTrack Features](#) page 87
- [SureTrack Screens](#) page 88

### 10.1.2 Quick Reference

#### SureTrack Community FAQ's

For the latest SureTrack Community information and answers to frequently asked questions visit: [mitchell1.com/support/suretrack-faqs/](http://mitchell1.com/support/suretrack-faqs/)

#### Using SureTrack for the First Time

If you have purchased a new diagnostic tool, you will need to create a SureTrack account before you can access SureTrack. See [Creating a SureTrack Account](#), on page 79 for instructions.

#### Login Scenarios

- I already have an active SureTrack account with username and password - [Logging In \(active account\)](#), on page 83.
- SureTrack has already expired, but I purchased a qualifying upgrade/plan and have a new SureTrack authorization code (reactivation) - [Logging In with New Authorization Code \(expired account\)](#), on page 85.
- SureTrack is still active, but I have purchased a qualifying upgrade/plan and have a new SureTrack authorization code (reactivation) - [Logging In with New Authorization Code \(active account\)](#), on page 84.

### 10.1.3 Finding your SureTrack Authorization Code

When you purchase a qualifying upgrade/plan, or platform from your Snap-on Representative, you will receive a SureTrack authorization code. The authorization code is printed on your sales receipt. Authorization codes are 12 digit alpha-numeric codes (e.g. 123ABCAP4-US).

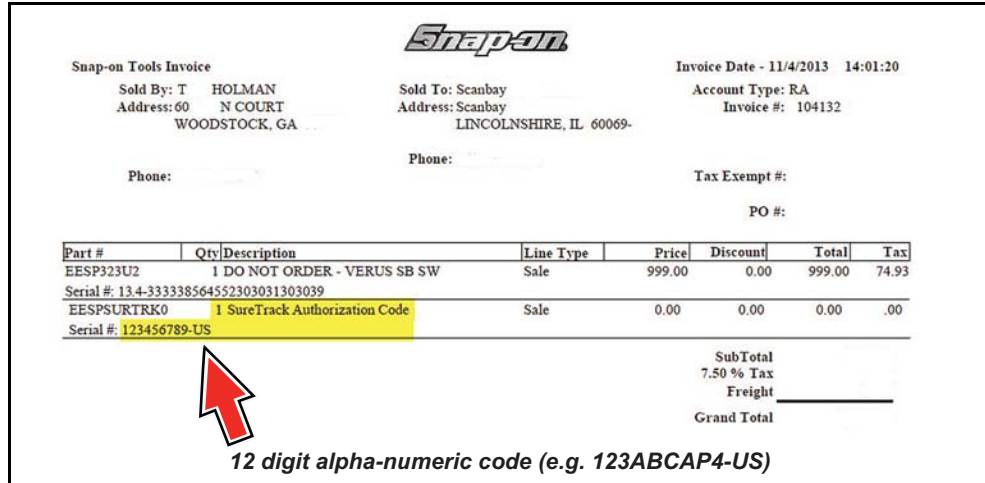

Figure 10-1

After obtaining a new upgrade/plan you will receive a new SureTrack authorization code.

Each time you purchase a qualifying diagnostics upgrade/plan you will be provided a new SureTrack authorization code. The authorization code will expire as noted in the upgrade/plan details. To log in with a new authorization code, see [Logging In with New Authorization Code \(expired account\)](#), on page 85.

## 10.1.4 Creating a SureTrack Account

### Use Requirements

To use SureTrack you must:

- Create a SureTrack Account, see [Creating an Account](#), on page 79.
- Have a current SureTrack Authorization Code, see [Finding your SureTrack Authorization Code](#), on page 78.
- Have access to a PC with an Internet connection.

### Creating an Account

If you are a new member (do not have an existing SureTrack account), you will need to complete the online registration before you can use SureTrack. Use the following procedure to create an account.

1. On your PC visit: <https://shopkeypro.com>
2. To create an account use the following illustrated instructions. Step numbers are provided in each illustration, follow the sequence to completion.

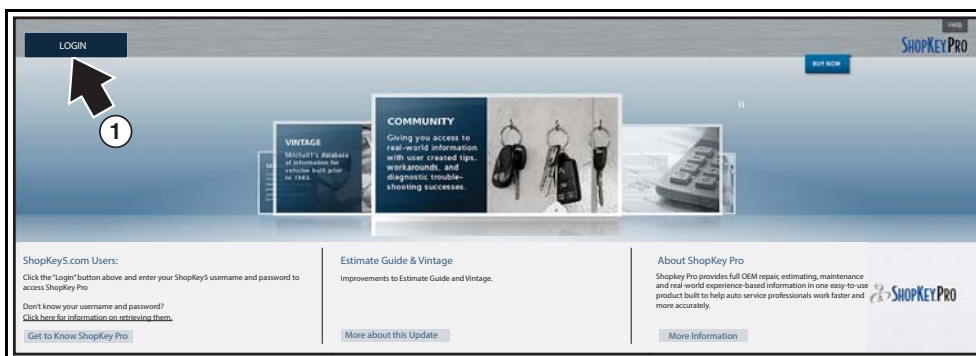

Figure 10-2

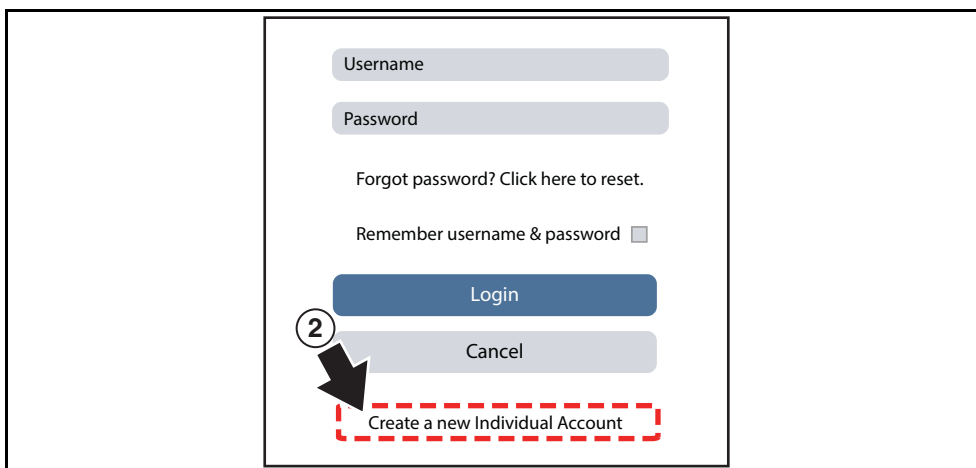

Figure 10-3

Email

**3** Enter all required\* information.

Email Address\*

Name Phone

First Name\* Last Name\* Phone Number

Address

Address Line 1

Address Line 2

City\* State\* Zipcode

Online Profile

Username\*

Password\* Retype Password\*

Cancel Create

**4**

Figure 10-4

Success X

Congratulations! Your account has been created.

This account can be used to contribute to the community and manage your profile.

To link this account to your shop, have your shop add you in Profile Manager.

Done

**5**

Figure 10-5

Username Password

**6**

Forgot password? Click here to reset. **7**

Remember username & password  **7**

Login

Cancel **8**

[Create a new Individual Account](#)

Figure 10-6

**9 Choose 3 security questions.**

Select three questions below. These questions will help us verify your identity should you forget your password.

Question 1: Choose a question...

Question 2: Choose a question...

Question 3: Choose a question...

Cancel Submit

**10**

Figure 10-7

**Snap-on**

Snap-on Tools Invoice Invoice Date - 11/4/2013 14:01:20

Sold By: T HOLMAN Sold To: Scanbay Account Type: RA  
 Address: 60 N COURT Address: Scanbay Invoice #: 104132  
 WOODSTOCK, GA LINCOLNSHIRE, IL 60069

Phone: Phone: Tax Exempt #: PO #:

Part #	Qty	Description	Line Type	Price	Discount	Total	Tax
EESP323U2	1	DO NOT ORDER - VERUS SB SW	Sale	999.00	0.00	999.00	74.93
Serial # 134-333338564552303031303039							
EESPSURTRKO	1	SureTrack Authorization Code	Sale	0.00	0.00	0.00	.00
Serial # 123456789-US							

Sub Total  
 7.50 % Tax  
 Freight  
 Grand Total

**11 Find the SureTrack Authorization Code on your sales receipt.**  
 12 digit alpha-numeric code (e.g. 123ABCAP4-US)

Figure 10-8

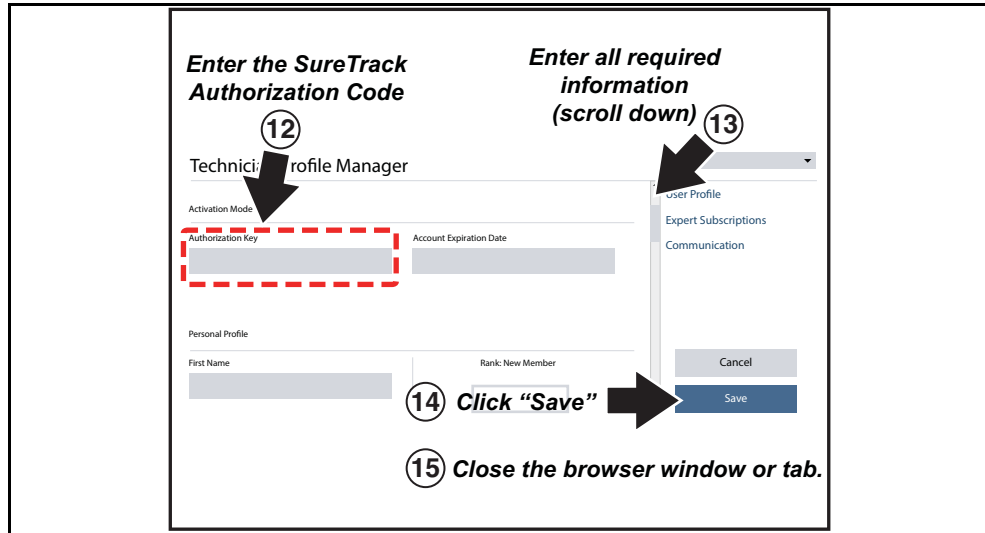

Figure 10-9



Figure 10-10

### 10.1.5 Logging In (active account)

If you have previously created a SureTrack account, and have a valid username and password, select **LOGIN** (Figure 10-11) from the ShopKey Pro start page, and then complete the login process (Figure 10-12). Once successfully logged in you will be directed to the 1Search *Limited* results page. See [SureTrack Screens](#), on page 88.

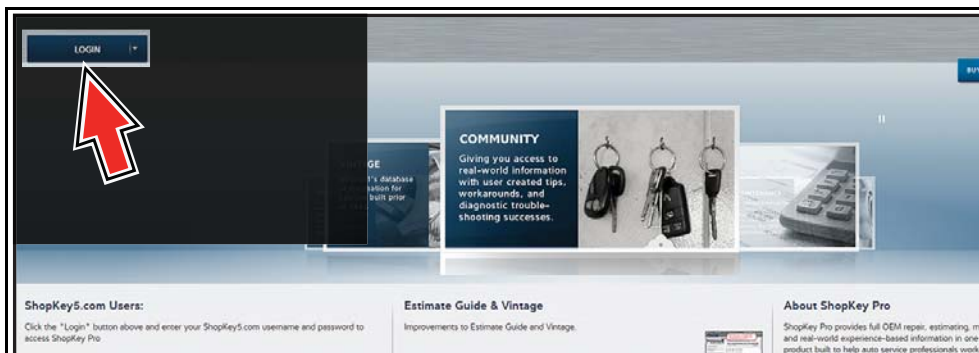

Figure 10-11

If you have previously selected the "remember me" checkbox in the login screen you will skip the login and be automatically directed to the 1Search Limited results page.

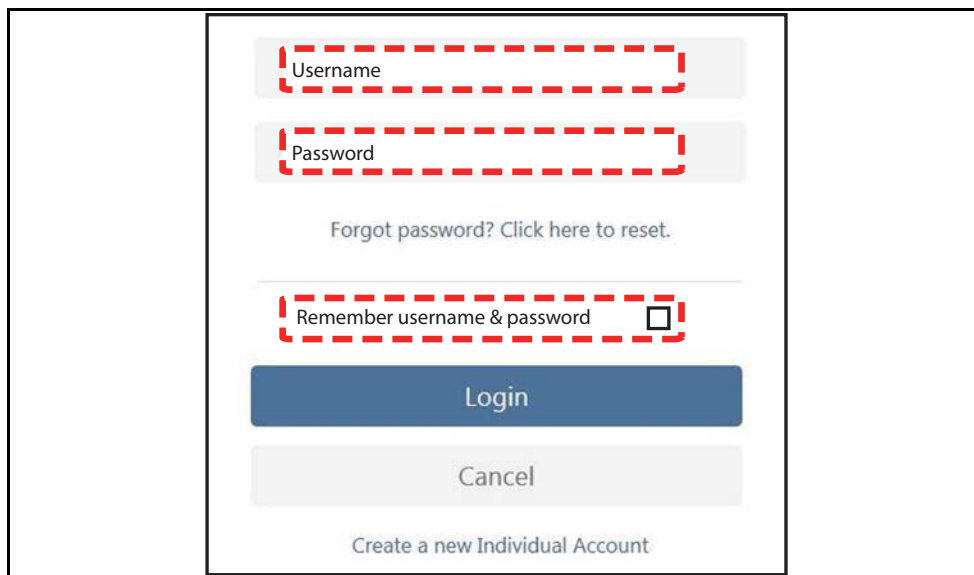

Figure 10-12



### 10.1.6 Logging In with New Authorization Code (active account)

Use the following instructions, if you have purchased a qualifying upgrade/plan and your SureTrack account is active (has not expired). To find your new authorization code, see [Finding your SureTrack Authorization Code](#), on page 78.

1. Log in to ShopKeyPro.com using your current username and password.
2. At the ShopKey Pro start page, select your username (Figure 10-13), then select **Profile Manager** from the dropdown menu.

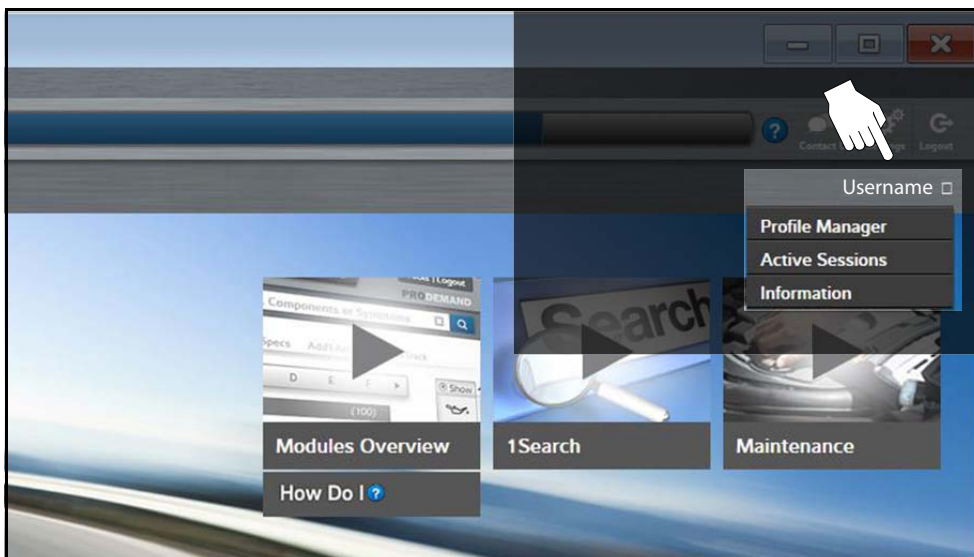

Figure 10-13

3. Log in to the Profile Manger (Figure 10-14) using your current username and password.
4. Enter your new **Authorization code** (Figure 10-14).

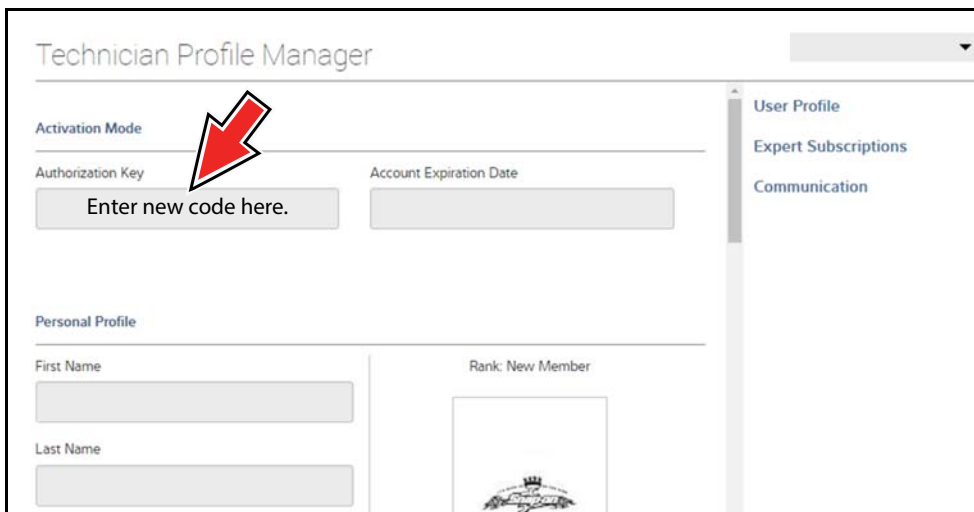

Figure 10-14

5. Review and update the rest of your profile and make sure all required fields are filled out.
6. Select **Save**.

7. Exit the Profile Manager by selecting your username (near the top right) and select **Logout**.
8. When the login screen displays, login using your current username and password.
9. Confirm the new expiration date by logging back into Profile Manger to check it.

### 10.1.7 Logging In with New Authorization Code (expired account)

Use the following instructions, if your SureTrack account has expired, and you have purchased a qualifying upgrade/plan. Your new upgrade/plan comes with a new SureTrack authorization code. To find your new authorization code, see [Finding your SureTrack Authorization Code](#), on page 78.

1. Log in to ShopKeyPro.com using your using your current username and password.

When your SureTrack account has expired, and you try to login you are directed to an information window ([Figure 10-15](#)).

2. Scroll down and select the link shown in ([Figure 10-15](#))

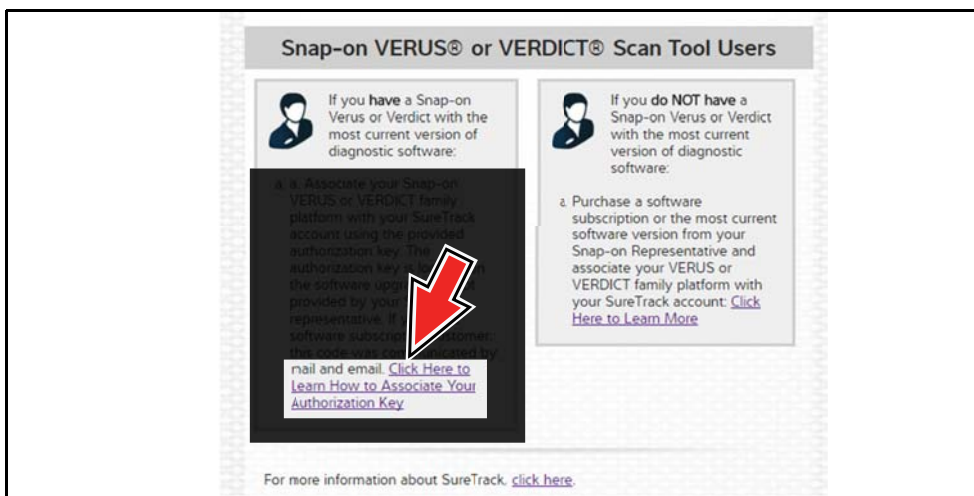

Figure 10-15

3. The SureTrack FAQ webpage opens ([Figure 10-16](#)).

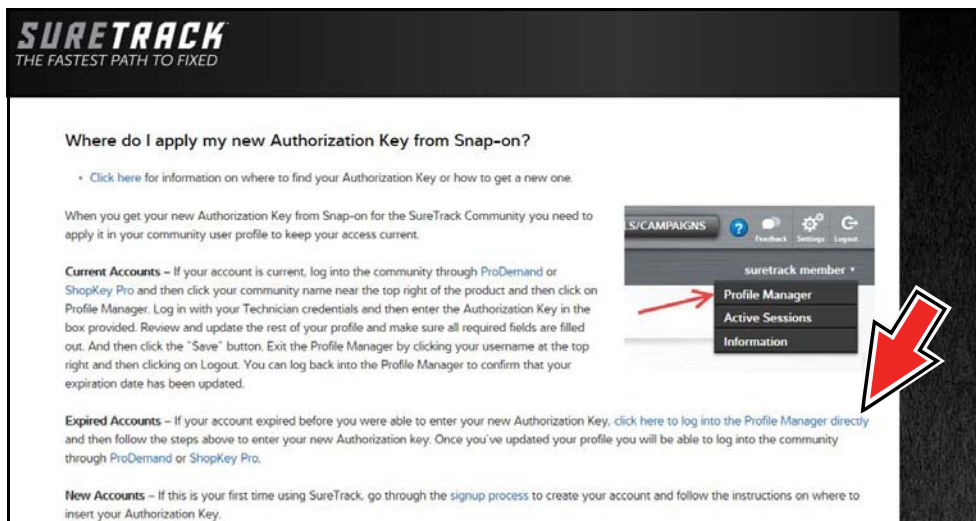

Figure 10-16

4. Scroll to the topic "Where do I apply my new Authorization Key from Snap-on?"
5. Select the link "click here to log into the profile manager login window directly".
  - URL - <https://profilemanager.mitchell1.com/technicianprofile/index>

The SureTrack renewal window opens.

6. Enter your current username and password.

The SureTrack Profile Manager window opens.

7. Enter your new **Authorization code** (Figure 10-17).

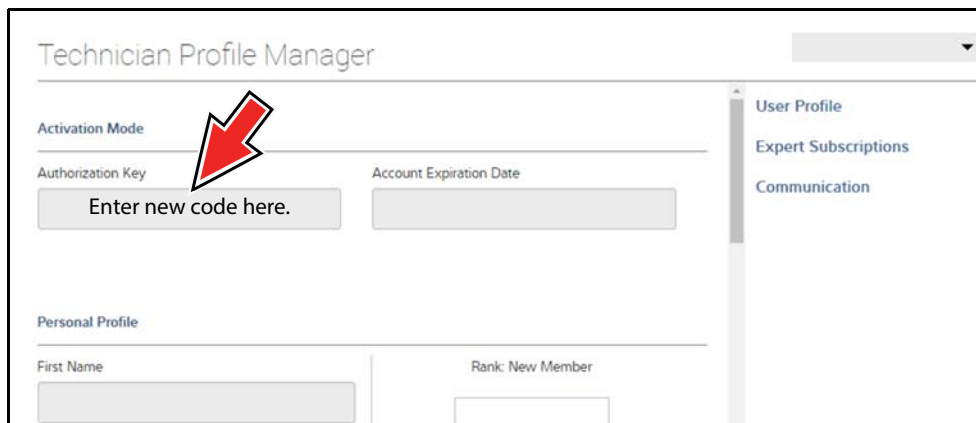

Figure 10-17

8. Review and update the rest of your profile and make sure all required fields are filled out.
9. Select **Save**.
10. Exit the Profile Manager by selecting your username (near the top right) and select **Logout**.
11. When the login screen displays, login using your current username and password.
12. Confirm the new expiration date by logging back into Profile Manger to check it.

## 10.1.8 SureTrack Features

SureTrack is an integrated part of ShopKey Pro, and includes two navigation modules providing search and forum capabilities:

- 1Search™ *Limited*
- Sure Track Community.

### 1Search™ *Limited*

The **1Search *Limited*** module includes the following information features:

- **Real Fixes and Tips** - real-world fixes and repair tips captured from actual repair orders and the experiences of professional technicians.
- **Common Repair Procedures Graph** - graphical display of the specific parts and procedures most frequently used to fix the selected code or symptom.
- **ProView** - provides graphical displays showing the direct relationship between a code or symptom to the component used to fix them.
- **Component Tests** - includes instructions on how to test the component, and descriptions of component operation, component locations, test locations, connector end views and even sample waveforms.
- **TSB's** - OEM technical service bulletins.
- **Safety Recalls and Campaigns** - safety recall and service campaign information.

### SureTrack Community

The **Sure Track Community** module is a forum-based application that connects you with a community of other professional technicians to find and share information, ask questions, and provide your own tips.

## 10.1.9 SureTrack Screens

### SureTrack Home Page (within ShopKey Pro)

The SureTrack Home page within ShopKey Pro includes:

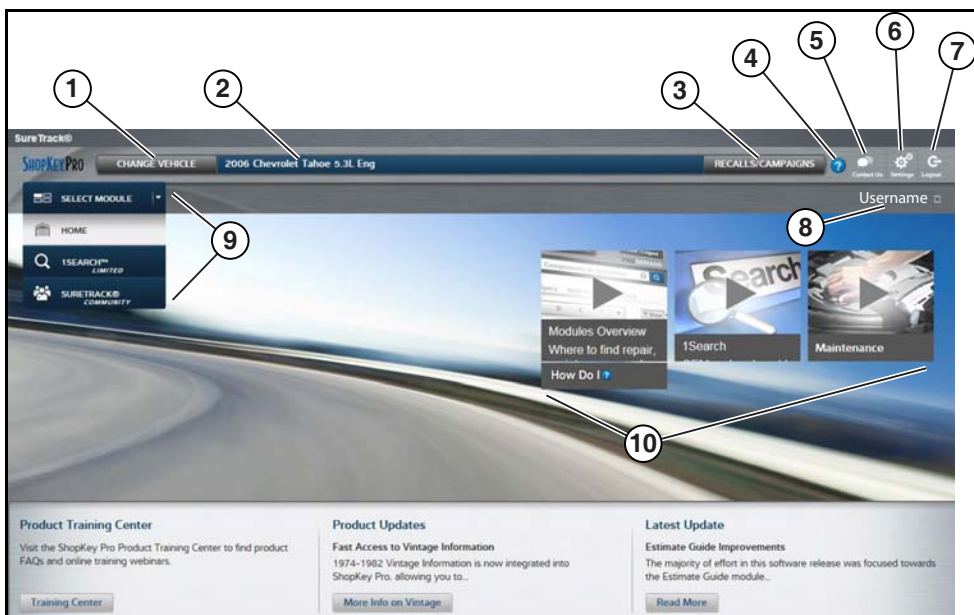

Figure 10-18

1. **Change Vehicle\*** - dropdown menu provides options to change the active vehicle
2. **Active Vehicle\*** - displays active vehicle
3. **Recall/Campaigns\*** - displays available OEM recalls and campaigns
4. **Help\*** - provides SureTrack and ShopKey Pro online help topics
5. **Contact Us\*** - provides options for contacting ShopKey Pro customer service
6. **Settings\*** - provides general setting options and information
7. **Logout\*** - logs you off of ShopKey Pro
8. **User ID options menu\*** - displays username, selecting opens Profile Manager and other options
9. **Main Menu (dropdown)\*** - Options are Home, 1Search *Limited*, and SureTrack Community
10. **General Training and Information Links (various)**

\* available on all pages

## 1Search *Limited* Top 10 Results Page

Selecting **1Search *Limited*** displays a Top 10 results page which includes:

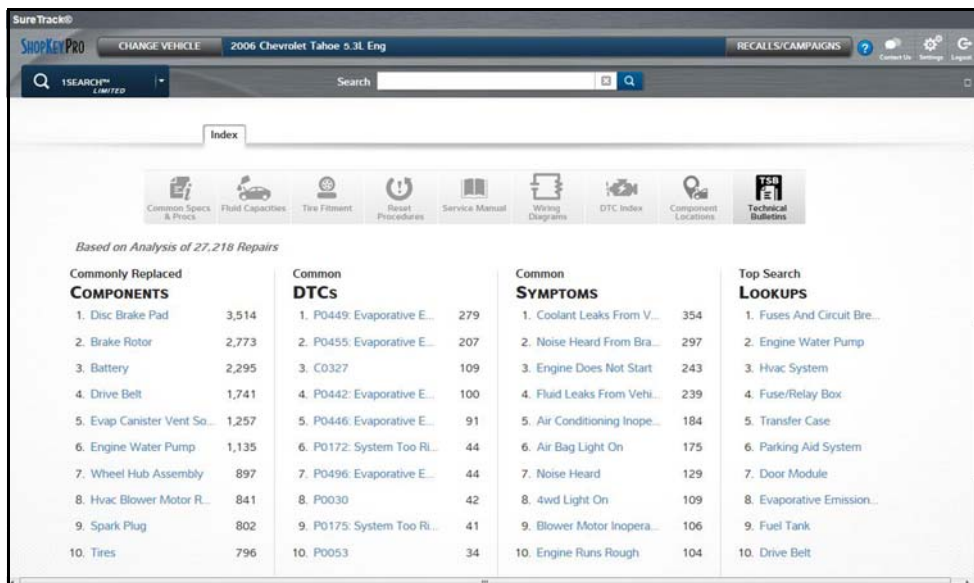

Figure 10-19

- **Search Bar** - use the search bar to enter a code, component or symptom to search. For best results keep search terms short (e.g. water pump, not - water pump replacement).
- **Page Tabs** - use the page tabs to navigate to related information (e.g. Index, SureTrack, ProView, etc) varies per application
- **Quick-links** - Technical Service Bulletins (TSBs) is the only available option
- **Repair Totals indicator** - displays the total number of repairs that all displayed data was based on
- **Top 10 lists** - display the most popular repairs and lookups by existing users for the selected vehicle (select an item from any list to view the Results Index, see [Results Index Page](#), on page 90)
  - Top 10 - Commonly Replaced Components
  - Top 10 - Common DTCs
  - Top 10 - Common Symptoms
  - Top 10 - Top Search Lookups

## Results Index Page

The Results Index page includes:

- **OEM Plus Results** - provides results that best match the exact search criteria, ranked in order with the closest match at the top.
- **SureTrack Results** - provides probable components related to the search criteria, ranked in order from the most likely to the least likely component.

Select an item from either list to view the results, see [SureTrack Results Page](#), on page 91).

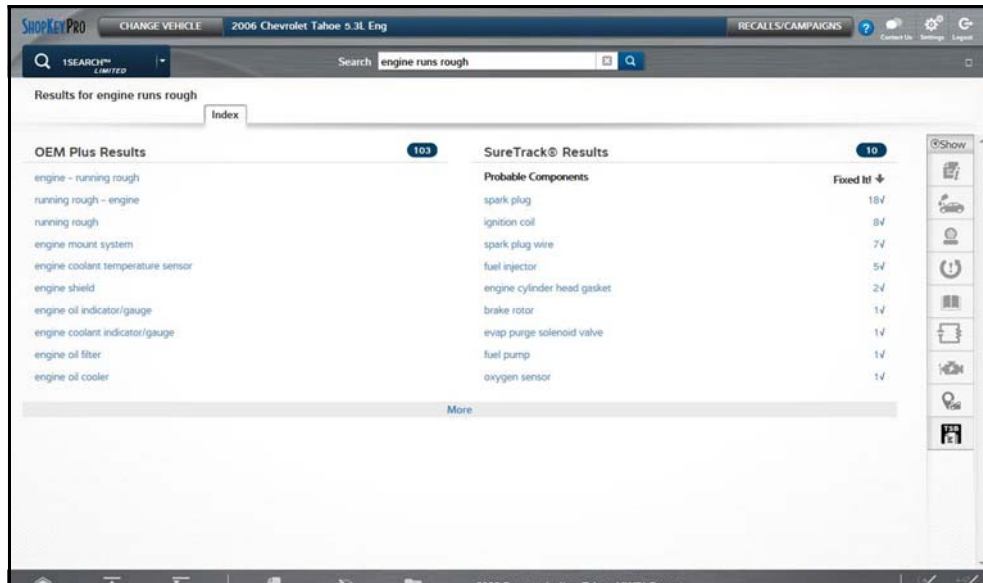

Figure 10-20

## SureTrack Results Page

Selecting an item from the Results Index page displays applicable repair information on the SureTrack results page.

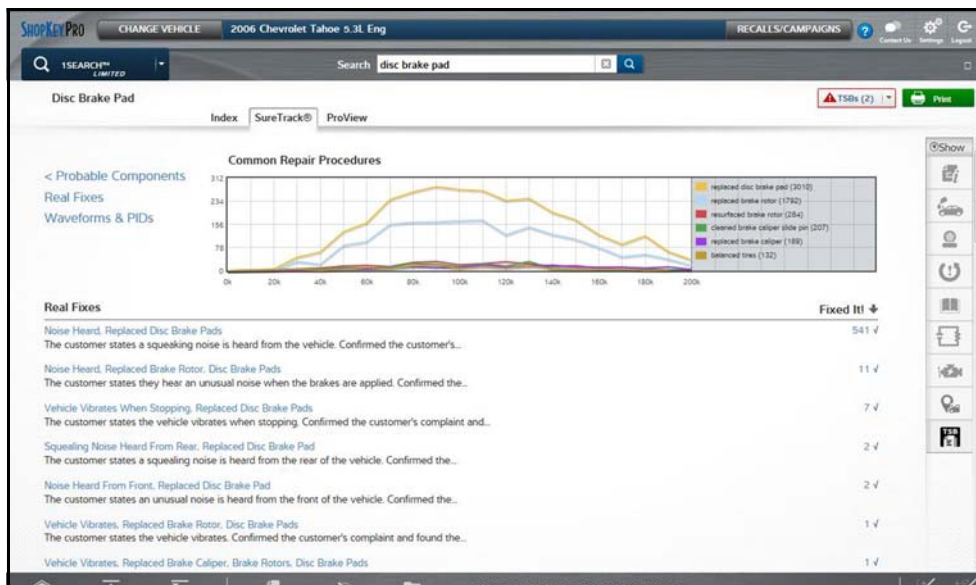

Figure 10-21

Information may include:

- **Real Fixes and Tips** - real-world fixes and repair tips captured from actual repair orders and the experiences of professional technicians.
- **Common Repair Procedures Graph** - graphical display of the specific parts and procedures most frequently used to fix the selected code or symptom.
- **Component Tests** - includes instructions on how to test the component, and descriptions of component operation, component locations, test locations, connector end views and even sample waveforms.
- **TSB's** - OEM technical service bulletins.
- **Safety Recalls and Campaigns** - safety recall and service campaign information.



## ProView Results Page

Selecting the **ProView** tab from the SureTrack results page opens ProView. ProView provides graphical displays showing the direct relationship between a code or symptom to the component used to fix them.

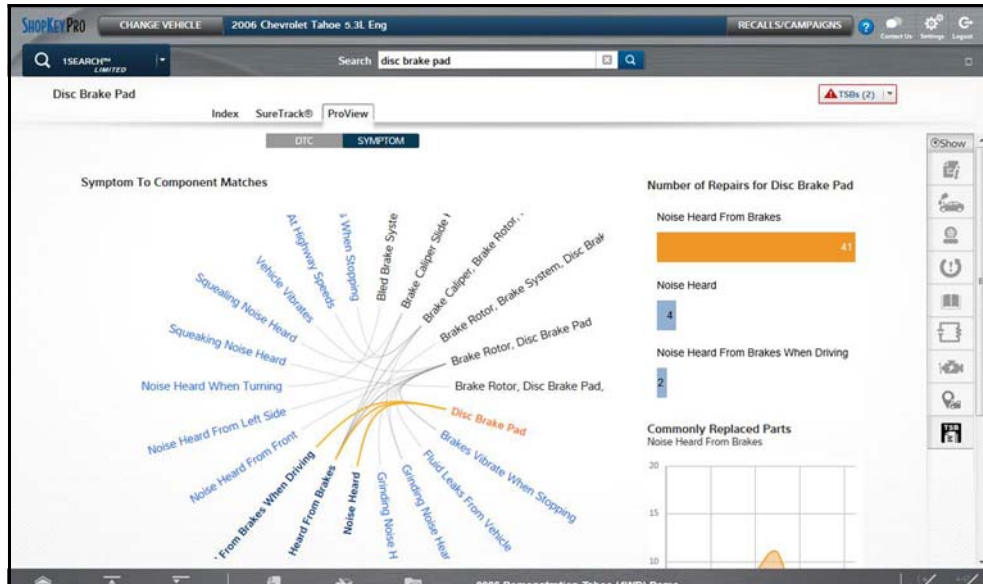

Figure 10-22

Information may include:

- **Radial Graph** - showing the relationship of the code or symptom to possible at fault components.
- **Component Frequency Graphs** - showing the most commonly replaced component for that code or symptom.
- **Common Replaced Parts Graphs** - showing the mileage at which the most common component is replaced.