



ShopStream
CONNECT™

User Manual

EAZ0057B01N Rev. A

Legal Information

Trademarks

Snap-on is a trademark, registered in the United States and other countries, of Snap-on Incorporated. This publication contains many Snap-on Incorporated trademarks, including but not limited to Snap-on and ShopStream Connect. All other marks are trademarks or registered trademarks of their respective holders.

Copyright Information

© 2017 Snap-on Incorporated. All rights reserved.

Disclaimer of Warranties and Limitation of Liabilities

All pictures and illustrations shown are for reference purposes only. All information, specifications and illustrations in this manual are based on the latest information available at the time of printing and are subject to change without notice. Some functions shown require connection to the Internet.

This documentation and the software that it supports is intended for use in North America only. Although these item may be globally accessible from the world wide web, they will only be promoted and supported within the North American market.

Snap-on reserves the right to make changes at any time without notice.

Contact Information (North America)

Websites:

Snap-on Diagnostics and Information

- <http://diagnostics.snapon.com>

Software Subscription - Learn how to always have the latest diagnostic software on your diagnostic tool

- <http://diagnostics.snapon.com/theprogram>

Training and Support (by platform) - Find specific support and training information for your diagnostic tool

- <http://diagnostics.snapon.com/cc.htm>

Training and Forums - Watch free instructional product videos and connect with and share your diagnostic tool questions, ideas and success stories

- <http://diagnostics.snapon.com/ForumsandTraining.htm>

Manuals / Technical Documentation - The information in this manual is periodically revised to ensure the latest information is included. Download the latest version of this manual and other related documentation at:

- <http://diagnostics.snapon.com/usermanuals>

Customer Care and Technical Assistance - Phone / E- mail

- 1-800-424-7226 / diagnostics_support@snapon.com

For technical assistance in all other markets, contact your selling agent

ShopStream Connect Quick Links

ShopStream Connect - download the ShopStream Connect PC-based companion software free

- <http://diagnostics.snapon.com/ssc>

ShopStream Connect FAQs - lists Frequently Asked Questions about ShopStream Connect

- <http://diagnostics.snapon.com/InformationProducts/ShopStreamConnect/FAQ.htm>

ShopStream Connect User Forum - connect with other ShopStream Connect users to ask questions and find answers to your questions

- [ShopStream Connect User Forum](#)

Customer Support - customer support contact information

- <http://diagnostics.snapon.com/Resources/CustomerCare.htm>

Safety Information

For your own safety, the safety of others, and to prevent damage to the product and vehicles upon which it is used, it is important that all instructions and safety messages in this manual and the accompanying *Important Safety Instructions* manual be read and understood by all persons operating, or coming into contact with the product, before operating. We suggest you store a copy of each manual near the product in sight of the operator.

For your safety, read all instructions. Use your diagnostic tools only as described in the Diagnostics Tool user's manual. Use only manufacturer recommended parts and accessories with your diagnostic tools.

This product is intended for use by properly trained and skilled professional automotive technicians. The safety messages presented throughout this manual and the accompanying *Important Safety Instructions* manual are reminders to the operator to exercise extreme care when using this product.

There are many variations in procedures, techniques, tools, and parts for servicing vehicles, as well as in the skill of the individual doing the work. Because of the vast number of test applications and variations in the products that can be tested with this instrument, we cannot possibly anticipate or provide advice or safety messages to cover every situation. It is the responsibility of the automotive technician to be knowledgeable of the system being tested. It is essential to use proper service methods and test procedures. It is important to perform tests in an appropriate and acceptable manner that does not endanger your safety, the safety of others in the work area, the equipment being used, or the vehicle being tested.

It is assumed that the operator has a thorough understanding of vehicle systems before using this product. Understanding of these system principles and operating theories is necessary for competent, safe and accurate use of this instrument.

Before using the equipment, always refer to and follow the safety messages and applicable test procedures provided by the manufacturer of the vehicle or equipment being tested. Use the product only as described in its user manual. Use only manufacturer recommended parts and accessories with your product.

Read, understand and follow all safety messages and instructions in this manual, the accompanying *Important Safety Instructions* manual, and on the test equipment.

Environmental Conditions:

- This product is intended for indoor use only
- This product is rated for Pollution Degree 2 (normal conditions)

Safety Signal Words

All safety messages contain a safety signal word that indicates the level of the hazard. An icon, when present, gives a graphical description of the hazard. Safety Signal words are:

DANGER

Indicates an imminently hazardous situation which, if not avoided, will result in death or serious injury to the operator or to bystanders.

WARNING

Indicates a potentially hazardous situation which, if not avoided, could result in death or serious injury to the operator or to bystanders.

CAUTION

Indicates a potentially hazardous situation which, if not avoided, may result in moderate or minor injury to the operator or to bystanders.

Safety Message Conventions

Safety messages are provided to help prevent personal injury and equipment damage. Safety messages communicate the hazard, hazard avoidance and possible consequences using three different type styles:

- Normal type states the hazard.
- **Bold type states how to avoid the hazard.**
- *Italic type states the possible consequences of not avoiding the hazard.*

An icon, when present, gives a graphical description of the potential hazard.

Safety Message Example

WARNING



Risk of unexpected vehicle movement.

- **Block drive wheels before performing a test with engine running.**

A moving vehicle can cause injury.

Important Safety Instructions

For a complete list of safety messages, refer to the accompanying *Important Safety Instructions* manual provided with your diagnostic tool or on our website. See the website contact information on page ii for website addresses.

SAVE THESE INSTRUCTIONS

Contents

Chapter 1: Using This Manual	3
Content	3
Conventions	3
Terminology	3
Symbols	3
Bold Text	4
Notes and Important Messages	4
Hyperlinks	4
Procedures	4
Chapter 2: Introduction	5
Chapter 3: Frequently Asked Questions (FAQs)	6
Chapter 4: Installation	7
Verifying Minimum PC Requirements	7
Verifying PC System Properties	7
Download and Installation	8
Starting SSC	11
Exiting SSC	12
Chapter 5: Diagnostic Tool Connection	13
Connecting the USB Cable and Communicating	13
MODIS Ultra, MODIS Edge, SOLUS Ultra, SOLUS Edge, VANTAGE Ultra, ETHOS+, ETHOS PRO, ETHOS Edge, and ETHOS Tech	16
SOLUS, SOLUS PRO, and Vantage PRO	18
ETHOS	19
MICROSCAN	20
MICROSCAN III	20
MODIS	21
Chapter 6: Basic Operation and Navigation	22
Main Screen Layout	22
Main Menu Bar	23
File Menu	23
Edit Menu	23
Tools Menu	24
Help Menu	26
Data Manager Screen Controls and Icons	27
Display Tabs	27
Controls	29
Data Manager Toolbar Icons	30
Chapter 7: Viewing Files	34
Scanner DataViewer	35
Menu Bar	36
Display Toolbar	41

Navigation Tools	42
Customizing the Display.....	44
Customizing the Parameter List.....	44
Scope File Viewer.....	46
Toolbar	47
Main Body	50
Profile Controls Window.....	50
Playback Control Toolbar.....	51
Image Viewer.....	52
Scanner Codes Viewer.....	53
Vehicle System Report Screen	53
Results Screen.....	54
Print Preview Screen	55
Chapter 8: Transferring Files	56
File Transfer Basics	56
Folder and Files	56
Displaying Files	56
Copying Files	57
Moving Files	57
Alternate Method.....	57
Chapter 9: Updating and Upgrading Software.....	58
Software Updates for ShopStream Connect.....	59
Software Updates (Service Releases) for Diagnostic Tools	60
Software Upgrades for Diagnostic Tools.....	60
Appendix A: Communicating with Early MODIS diagnostic tools.....	63
Viewing Early MODIS Files	63
Service Releases and early MODIS diagnostic tools	64

1.1 Content

This manual contains basic operating instructions and is structured in a manner to help you become familiar with and perform basic operations.

The illustrations in this manual are intended as reference only and may not depict actual screen results, information, functions or standard equipment.

1.2 Conventions

The following conventions are used.

1.2.1 Terminology

The terms “Scanner” and “Scanner function” are used to describe the Scanner Function(s) of the diagnostic tool.

Examples:

- Select **Scanner** from the Home screen.
- From the Scanner main menu select **Continue**.
- The Scanner function provides many diagnostic tests.

The term “select” describes tapping/touching an icon on the touch screen, or highlighting an icon or menu choice and then selecting the confirmation menu choice such as **Continue, Accept, OK, Yes, or other similar** choice.

Abbreviated example for the following procedure: “Select **Brightness**”

1. Navigate to and highlight the **Brightness** selection.
2. Select **OK, or similar**, button.

1.2.2 Symbols

Different types of arrows are used. The “greater than” arrow (>) indicates an abbreviated set of selection (navigation) instructions.

Abbreviated example for the following procedure: “Select **Tools > Connect-to-PC**”

1. Select **Tools** from the home screen.
2. Highlight **Connect-to-PC** on the Tools menu.
3. Select **Connect-to-PC**.

The solid arrows (◀, ▶, ▼, ▲) are navigational instructions for the four directions of the directional buttons.

Example: Press the down ▼ arrow.

1.2.3 Bold Text

Bold emphasis is used in procedures to highlight selectable items such as control buttons, icons and menu options.

Example: Press the **OK** button

1.2.4 Notes and Important Messages

The following messages are used.

Notes

A NOTE provides helpful information such as additional explanations, tips, and comments.

Example:

**NOTE:**

For additional information refer to...

Important

IMPORTANT indicates a situation which, if not avoided, may result in damage to the test equipment or vehicle.

Example:

IMPORTANT:

Do not disconnect the data cable while the diagnostic tool is communicating with the ECM.

1.2.5 Hyperlinks

Hyperlinks, or hot links, that take you to other related articles, procedures, and illustrations are available in electronic documents. Blue colored text indicates a selectable hyperlink.

Example:

IMPORTANT:

Read all applicable [Safety Information](#) before using this diagnostic tool!

1.2.6 Procedures

An arrow icon in the left-margin area indicates a procedure.

Example:

**To change screen views:**

1. Select the **Graph** icon.
The dropdown menu displays.
2. Select an option from the menu.
The screen layout changes to the format selected.

The ShopStream Connect™ (**SSC**) software is PC-based software that extends the capabilities of your diagnostic tools. Using ShopStream Connect software with your diagnostic tools allows you to do the following:

- View, Print, and Manage data saved from your Diagnostic tool.
- Move and copy your data between the diagnostic tool and your PC.
- View and Print trouble codes saved with select diagnostic tools. This allows you to share the data in a report format with vehicle owners or other technicians.
- Add or edit notes and comments to diagnostic tool data files.
- Download and install diagnostic tool software updates and upgrades.

ShopStream Connect can be used with the following diagnostic tools:	
Note: Application and features will vary	
ETHOS Family	
Use the quick links , to view connection instructions	ETHOS®
	ETHOS®+
	ETHOS® Tech
	ETHOS® Pro
	ETHOS® Edge
SOLUS Family	
	SOLUS™
	SOLUS™ PRO
	SOLUS Ultra®
	SOLUS™ Edge
MODIS Family	
	MODIS™
	MODIS™ Ultra
	MODIS™ Edge
Vantage Family	
	Vantage PRO™
	VANTAGE® Ultra
MICROSCAN Family	
	MICROSCAN®
	MICROSCAN® III

Frequently Asked Questions (FAQs)

How can I obtain the latest version of ShopStream Connect™?

The full installation of ShopStream Connect is available from the [Snap-on Diagnostics web site](#). If you already have a version of ShopStream Connect installed, the automatic update feature will notify you when a new version is available, and guides you through the update procedure.

What operating systems are supported?

ShopStream Connect supports, Windows XP®, 7, Windows 8/8.1, Windows 10.

Why do I need the .NET 2.0 Framework to be installed on my PC?

Windows XP, 8/8.1 and 10 only

The ShopStream Connect application was developed using Microsoft® software components and requires .NET 2.0 framework. It can be installed over previous versions of .NET (e.g. 1.0 and 1.1).

The ShopStream Connect installation automatically detects if this version of the framework is installed on your PC, and if not found will request that you install it before it can proceed. Windows XP, 8/8.1 and 10 users may need to install .NET 2.0.

The Microsoft .NET framework version 2.0 can be downloaded from our website [here](#).

Further explanations and detail on the .NET Framework can be found [here](#).

Why do I need the .NET 4.0 Framework to be installed on my PC?

Windows XP and 7 only

The ShopStream Connect Scanner codes viewer uses Microsoft components that may require .NET 4.0 support installed on your PC. Some Windows XP and 7 computers may prompt you to install .NET 4.0.

An example of the screens displayed when installing .NET 4.0 on a Windows XP or 7 computer can be found [here](#).

The Microsoft .NET framework version 4.0 can be downloaded from our website [here](#).

This chapter describes how to download and install ShopStream Connect (SSC) on your PC.

4.1 Verifying Minimum PC Requirements

Before installing the software, verify your PC meets the following requirements:

IMPORTANT:

If your PC does not meet the following minimum requirements, do not attempt to install ShopStream Connect.

- System Properties:
 - Operating system—Windows® XP, 7, 8/8.1 or 10 (Windows XP must be updated to Microsoft .NET Framework Version 4.0)
 - Processor—Intel® Pentium 4 or later, or equivalent
 - Memory—512MB RAM Minimum, 1GB RAM Recommended
- Hard Drive—500 MB free space
- CD-ROM, DVD, or DVD-ROM drive (*optional*)
- Display Resolution XGA 1024 x 768 or Higher
- USB 2.0 or later
- Internet Explorer 6.0 or higher
- Internet connection
- Adobe® Reader software (free download at www.adobe.com/products/reader)

The following may also be needed, depending on the diagnostic tool:

- USB cable (most models), see [“Connecting the USB Cable and Communicating” on page 13](#)
- A CompactFlash® (CF) card reader (for updating SOLUS, Vantage PRO, and early MODIS diagnostic tools).

4.1.1 Verifying PC System Properties

The following procedures will vary depending on your PC operating system. Multiple methods are listed for convenience.



To check PC system properties:

- Navigate to **Control Panel**, then select **System** or **Properties**.
- Navigate to **Computer** then select **System Properties**.

**To check PC hard drive free space:**

1. Navigate to **Computer, My Computer, or Windows Explorer**.
2. Select your local drive, or the drive where the SSC software will reside and select **Properties** or **View > Details** (Figure 4-1).

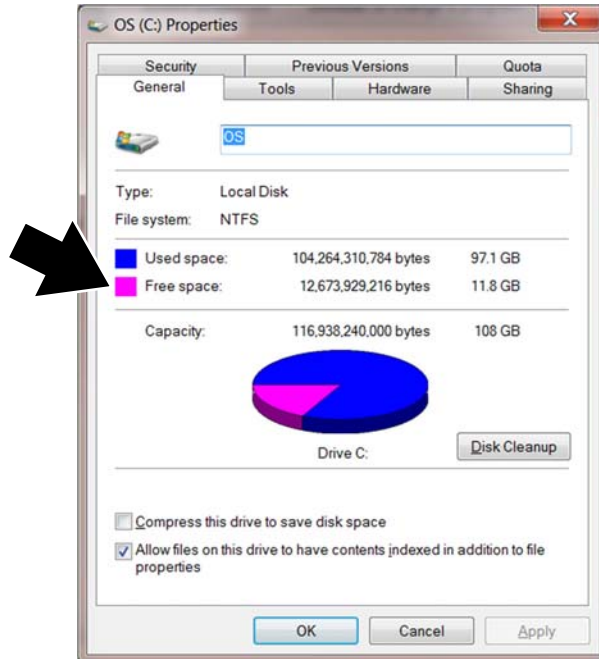

Figure 4-1 Typical PC hard drive free space details

4.2 Download and Installation

**To download the SSC software:**

1. From your PC, using your Internet browser, go to the ShopStream Connect website. See website information on page “ii” of this manual.
2. Download the SSC software.

**To install the SSC software:**

1. If the SSC autorun installer does not automatically start the installation, double-click the SSC installation file **ShopStreamConnect.exe**, that downloaded onto your PC.
The Setup Wizard launches.
2. Select **Next** (Figure 4-2).

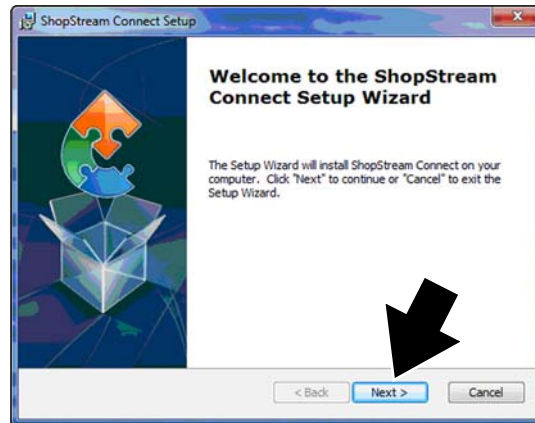

Figure 4-2 Typical Welcome screen

3. Choose your geographical market location.
4. From the License Agreement screen:
 - a. Scroll to read through the entire Snap-on Incorporated Software License Agreement.
 - b. Select the **I accept the terms of the license agreement** check box.
 - c. Select **Next** to continue (Figure 4-3).

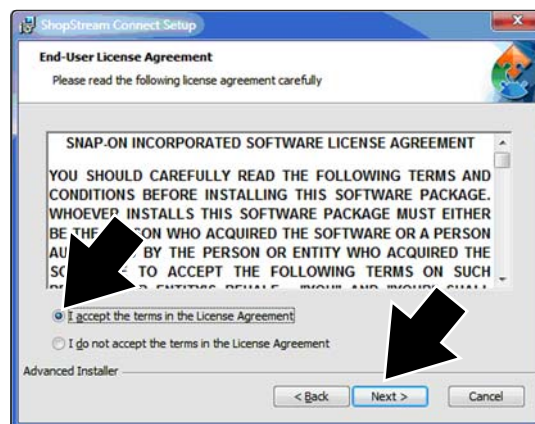

Figure 4-3 Typical License Agreement screen

5. Select **Install** to begin installation (Figure 4-4).
Installation status screens display to indicate progress as the program installs.

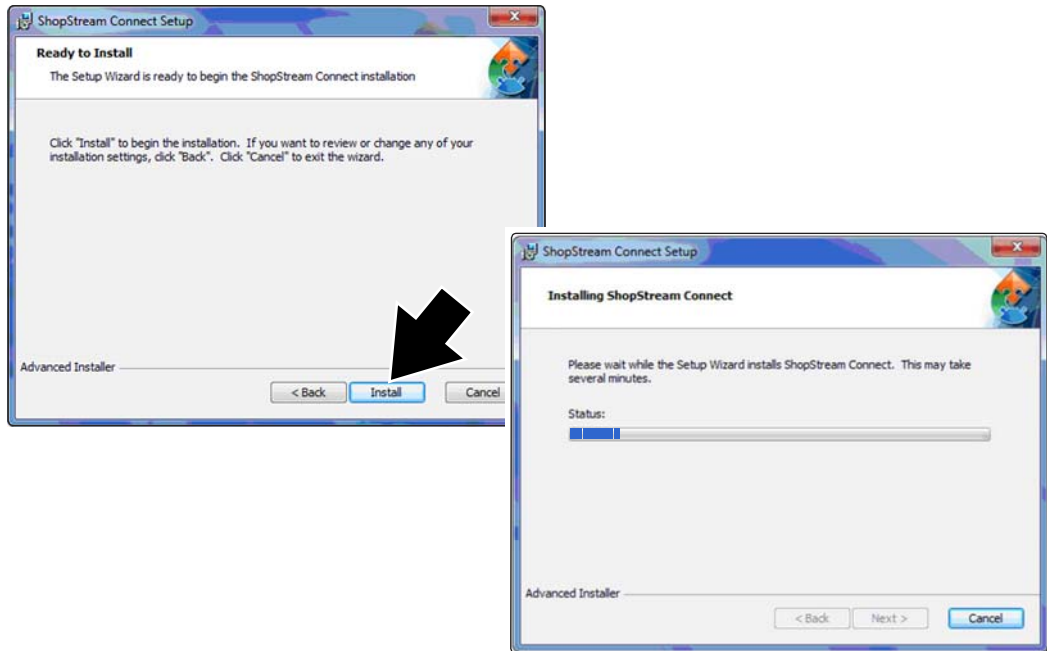

Figure 4-4 Typical install and status screens

- 6. Select **Finish**. (Figure 4-5).

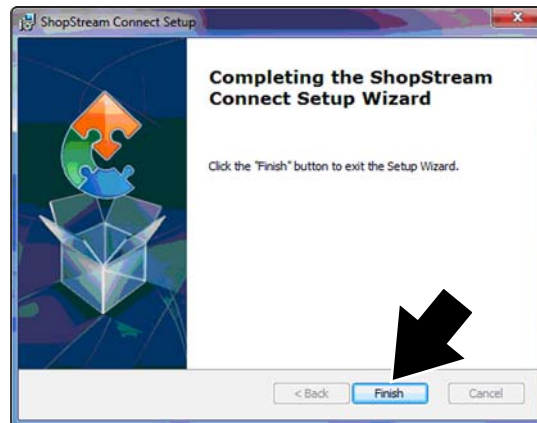

Figure 4-5 Typical Complete screen

A shortcut icon is added to the desktop (Figure 4-6).



Figure 4-6 ShopStream Connect icon

4.3 Starting SSC

▶ To start SSC:

If not already installed, install the ShopStream Connect software on your PC. See, “[Installation](#)” on [page 7](#).

Starting the software can vary depending on the Windows operating system installed on your PC and your setup preferences. Typically SSC can be started from:

- The ShopStream Connect icon on the Windows desktop (automatically created during installation)
 - Double-click **ShopStream Connect** icon .
- The Windows Start menu
 - Select directly from the Start Menu ([Figure 4-7](#) left) programs if available, or
 - Select **Start > All Programs > ShopStream Connect > ShopStream Connect** ([Figure 4-7](#) right).

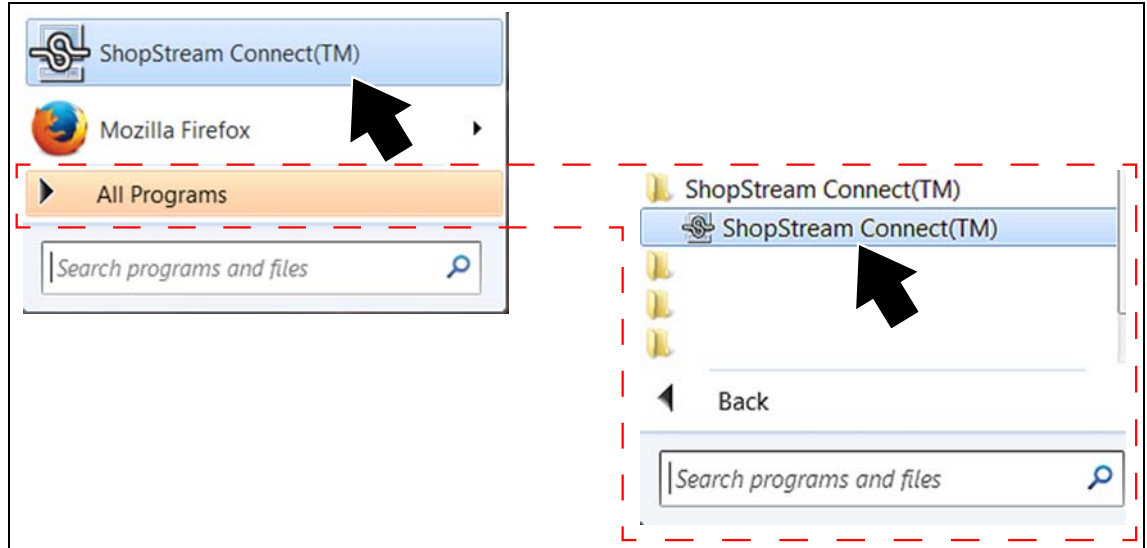

Figure 4-7 Typical Windows 7 start menu selections

4.4 Exiting SSC

 To exit SSC:

Select **Exit** from the dropdown File menu ([Figure 4-8](#)).

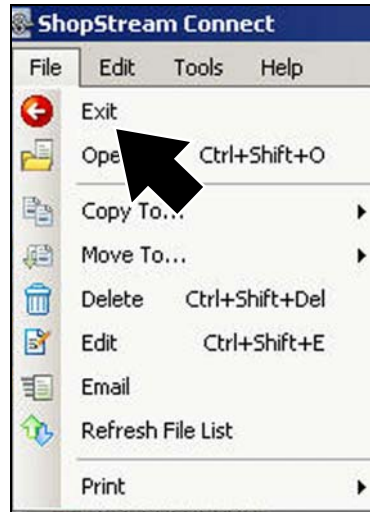



Figure 4-8 Exit selection

This chapter describes how to connect the diagnostic tool to your PC and establish communication.

5.1 Connecting the USB Cable and Communicating

There are two different USB cables used to connect diagnostic tools to PCs. The type of cable used is dependent upon the diagnostic tool USB connection.

Both cables use an **A-Type** USB connector on one end (shown on left in illustrations below) to connect to a PC. The other end of the cable, has either a **Mini-b (5-pin)** or **B-Type** USB connector.

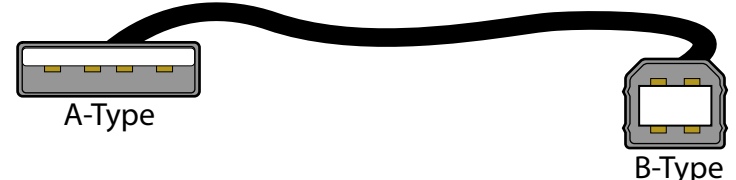
USB cables types	
Used with ALL diagnostic tools, except SOLUS and MICROSCAN	 <p>A-Type Mini-b</p>
Used only with SOLUS and MICROSCAN diagnostic tools	 <p>A-Type B-Type</p>

▶ Connecting the USB cable to the diagnostic tool and PC:

1. Connect the **A-Type** end of the cable into the USB jack on your PC.
2. Connect the other end of the cable into the USB jack on the diagnostic tool.

▶ Establishing communication:







Establishing communication between the PC and diagnostic tool, varies depending on the diagnostic tool.

In the following table, click-on the image to see the communication instructions for that diagnostic tool.

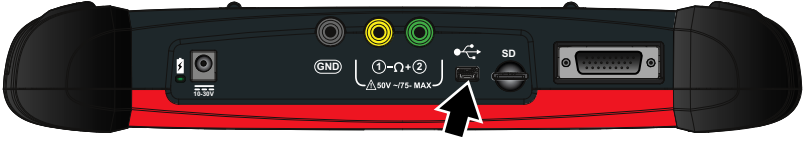

NOTE:

The diagnostic tool illustrations shown are for reference only.

Diagnostic Tool	USB Connector Type	Location of USB connector <i>(click image to see communication instructions)</i>
ETHOS see page 19	Mini-b	
ETHOS +, ETHOS PRO, and ETHOS Tech see page 16	Mini-b	
ETHOS Edge see page 16	Mini-b	
MODIS ULTRA see page 16	Mini-b	
MODIS Edge see page 16	Mini-b	
SOLUS see page 18	B-Type	
SOLUS PRO see page 18	Mini-b	

<p>SOLUS Ultra see page 16</p>	<p>Mini-b</p>	
<p>SOLUS Edge see page 16</p>	<p>Mini-b</p>	
<p>Vantage PRO see page 18</p>	<p>Mini-b</p>	
<p>VANTAGE Ultra see page 16</p>	<p>Mini-b</p>	
<p>MICROSCAN see page 20</p>	<p>B-Type</p>	
<p>MICROSCAN III see page 20</p>	<p>Mini-b</p>	
<p>MODIS see page 21</p>	<p>Mini-b (on circuit board, above the compact flash card under the left handgrip)</p>	

NOTE: Older MODIS diagnostic tools do not have a USB jack on the circuit board by the side CF card slot, and they cannot be connected to a PC with a cable. However, saved files can be viewed with ShopStream Connect and older diagnostic tools can be upgraded to current specifications. Refer to "[Communicating with Early MODIS diagnostic tools](#)" on page 63 for additional information.

**NOTE:**

The screen images shown in the following sections are for reference only, and may not depict actual screens.

5.1.1 MODIS Ultra, MODIS Edge, SOLUS Ultra, SOLUS Edge, VANTAGE Ultra, ETHOS+, ETHOS PRO, ETHOS Edge, and ETHOS Tech

**Establishing communication:**

1. Connect the diagnostic tool to the PC using the applicable USB cable, see "[Connecting the USB Cable and Communicating](#)" on page 13.
2. Connect the AC/DC power adapter, then turn on the diagnostic tool.
3. From the Home screen, select **Tools > Connect-to-PC** (Figure 5-1 upper left).
4. Select **Continue** (Figure 5-1 right center).

The now in Connect-to-PC mode screen displays (Figure 5-1 lower left).

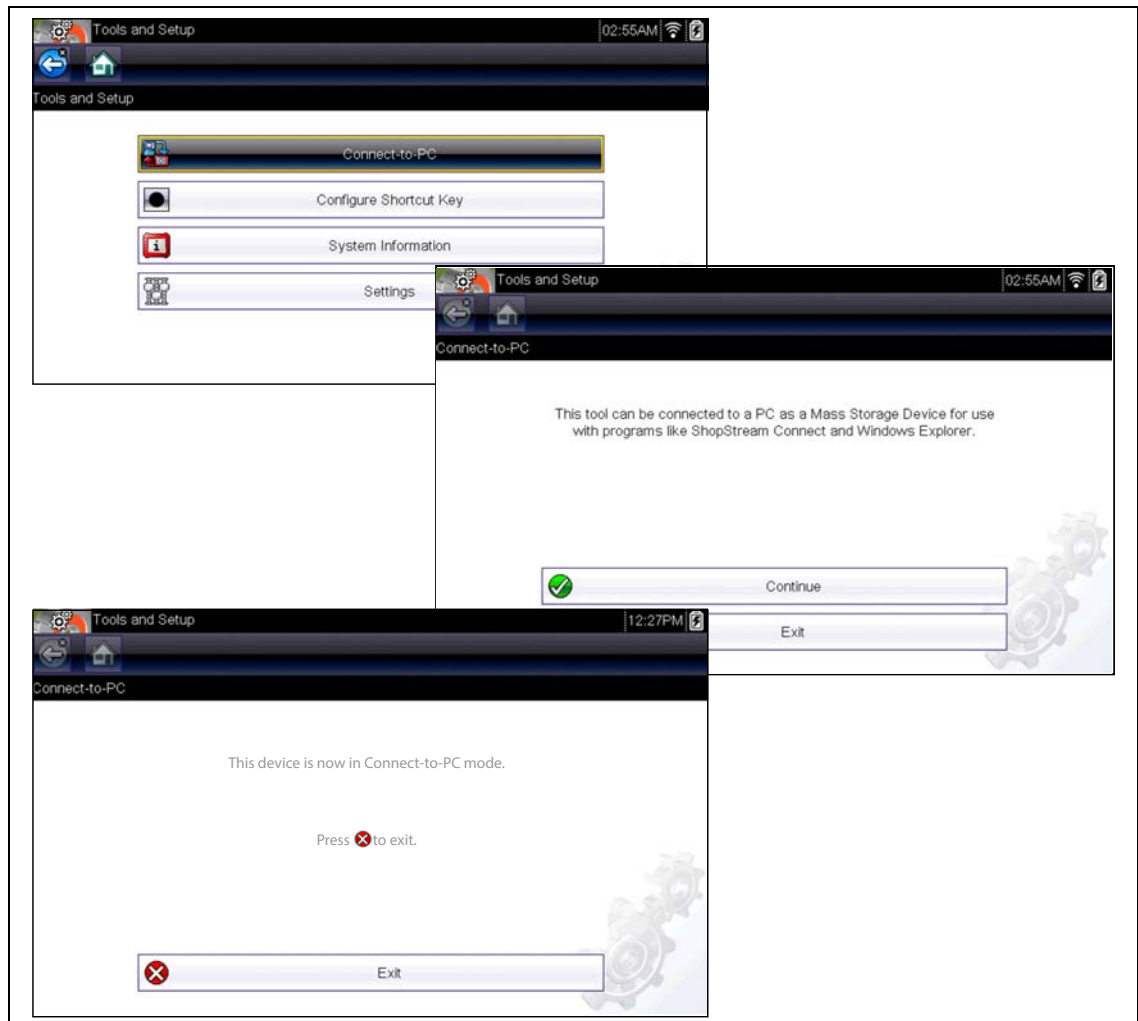

Figure 5-1 Connect-to-PC screens

5. On the PC, start the ShopStream Connect software (if it does not automatically start), see ["Connecting the USB Cable and Communicating" on page 13](#).

ShopStream Connect should default to display the data stored on your diagnostic tool. If not, select your applicable diagnostic tool from the end of the file directory list.

To Stop communication select **Exit** ([Figure 5-1](#) lower left).

5.1.2 SOLUS, SOLUS PRO, and Vantage PRO

▶ Establishing communication:

1. Connect the AC/DC power adapter, then turn on the diagnostic tool.
2. From the Main Menu, select **UTILITIES > Connect to PC** (Figure 5-2), and then press **Y**.

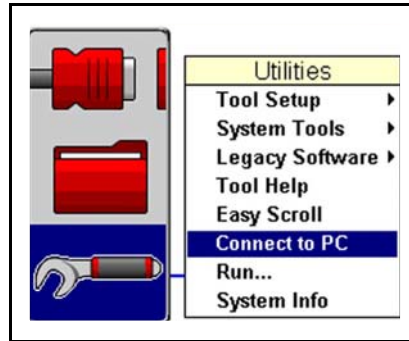

Figure 5-2 Typical Utilities Menu

3. Press **Y** to turn off the diagnostic tool when the configure for Connect to PC message displays.
4. Turn on the diagnostic tool.
The Connect-to-PC message displays (Figure 5-3).



Figure 5-3 Typical Connect to PC mode messages

5. Connect the diagnostic tool to the PC using the applicable USB cable, see "[Connecting the USB Cable and Communicating](#)" on page 13.
If a "removable disk" dialog automatically opens on your PC, select **Cancel**.
6. On the PC, start the ShopStream Connect software (if it does not automatically start), see "[Connecting the USB Cable and Communicating](#)" on page 13.
ShopStream Connect should default to display the data stored on your diagnostic tool. If not, select your applicable diagnostic tool from the end of the file directory list.

5.1.3 ETHOS



Establishing communication:

1. Connect the AC/DC power adapter, then turn on the diagnostic tool.
2. Connect the diagnostic tool to the PC using the applicable USB cable, see "[Connecting the USB Cable and Communicating](#)" on page 13.
3. On the diagnostic tool, simultaneously hold down the **Y/✓** and **N/x** buttons, and then press the **Power** button.

The Service Menu displays ([Figure 5-4](#)).

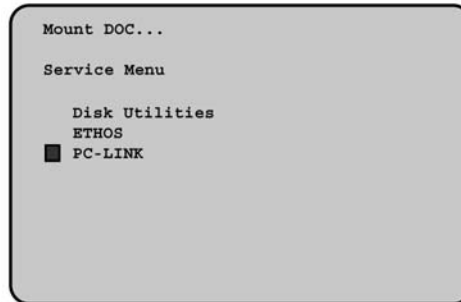

Figure 5-4 Service menu

4. From the Service Menu, select **PC-LINK**.

IMPORTANT:

Unless you are specifically instructed to do so and have precise instructions, DO NOT attempt to use any other functions on the Service Menu. Improper use of Service Menu functions can corrupt the internal file structure and render the diagnostic tool inoperative.

5. On the PC, start the ShopStream Connect software (if it does not automatically start), see "[Connecting the USB Cable and Communicating](#)" on page 13.

If a "removable disk" dialog automatically opens on your PC, select **Cancel**.

ShopStream Connect should display the data stored on your ETHOS diagnostic tool. If not, select **ETHOS** from the end of the file directory list.

Once communication is established between your PC and ETHOS, the Mounting screen displays on your ETHOS diagnostic tool ([Figure 5-5](#)).

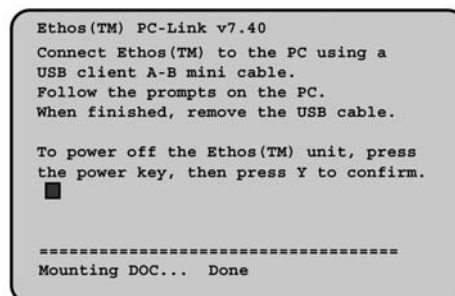

Figure 5-5 Mounting screen

5.1.4 MICROSCAN

▶ Establishing communication:

1. Connect the diagnostic tool to the PC using the applicable USB cable, see ["Connecting the USB Cable and Communicating" on page 13](#).

The MICROSCAN automatically powers up and displays the service menu.

2. Select **Connect to PC** from the menu (Figure 5-6), then press **Y** to make the selection.

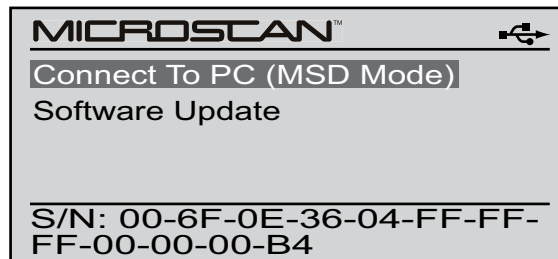

Figure 5-6 Connect to PC screen

The MICROSCAN screen changes to indicate it is now connected to the PC.

3. On the PC, start the ShopStream Connect software (if it does not automatically start), see ["Connecting the USB Cable and Communicating" on page 13](#).
4. ShopStream Connect should default to display the data stored on your MICROSCAN diagnostic tool. If not, select **MICROSCAN** from the end of the file directory list.

5.1.5 MICROSCAN III

▶ Establishing communication:

1. Connect the diagnostic tool to the PC using the applicable USB cable, see ["Connecting the USB Cable and Communicating" on page 13](#).

The MICROSCAN III automatically powers up and displays the USB Menu (Figure 5-7).

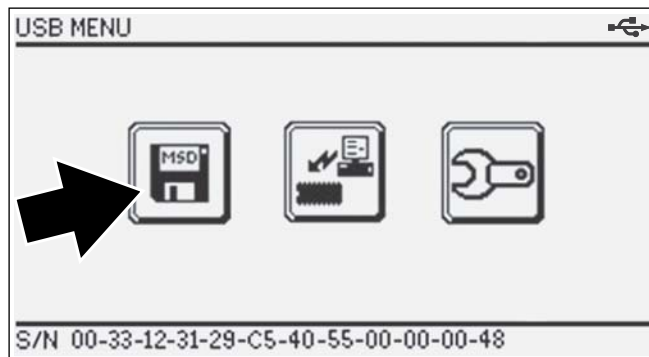

Figure 5-7 USB menu

2. Select the **Connect to PC** icon (Figure 5-7).
The MICROSCAN III screen changes to indicate it is now connected to the PC.
3. On the PC, start the ShopStream Connect software (if it does not automatically start), see ["Connecting the USB Cable and Communicating" on page 13](#).
4. ShopStream Connect should default to display the data stored on your MICROSCAN III diagnostic tool. If not, select **MICROSCAN III** from the end of the file directory list.

5.1.6 MODIS

▶ Establishing communication:

IMPORTANT:

Older MODIS diagnostic tools do not have a USB jack, and cannot be connected to a PC using a USB cable. However, saved files can be viewed using ShopStream Connect.

See "[Communicating with Early MODIS diagnostic tools](#)" on page 63 for additional information.

1. Connect the AC/DC power adapter, then turn on the diagnostic tool.
2. From the Main Menu, select **UTILITIES > Connect to PC**, and then press **Y**.
3. Press **Y** to turn off the diagnostic tool when the configure for Connect to PC message displays.
4. Turn off the diagnostic tool.

The Connect to PC message displays ([Figure 5-8](#))

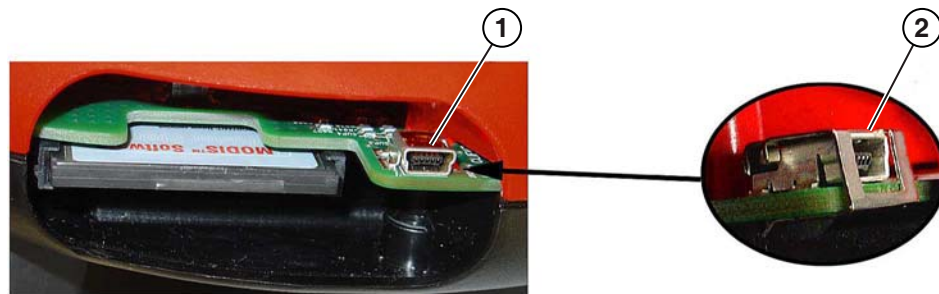

Figure 5-8 Connect to PC mode message

5. Connect the diagnostic tool to the PC using the applicable USB cable, see "[Connecting the USB Cable and Communicating](#)" on page 13.

IMPORTANT:

A strain relief clip must be installed ([Figure 5-9](#)) to help secure the connector to the circuit board, contact Technical Support for information.



1— without strain relief clip

2— with strain relief clip

Figure 5-9

If a "removable disk" dialog automatically opens on your PC, select **Cancel**.

6. On the PC, start the ShopStream Connect software (if it does not automatically start), see "[Connecting the USB Cable and Communicating](#)" on page 13.

ShopStream Connect should default to display the data stored on your MODIS diagnostic tool. If not, select **MODIS** from the end of the file directory list.

6.1 Main Screen Layout

The following explains the screen layout for ShopStream Connect™ software.

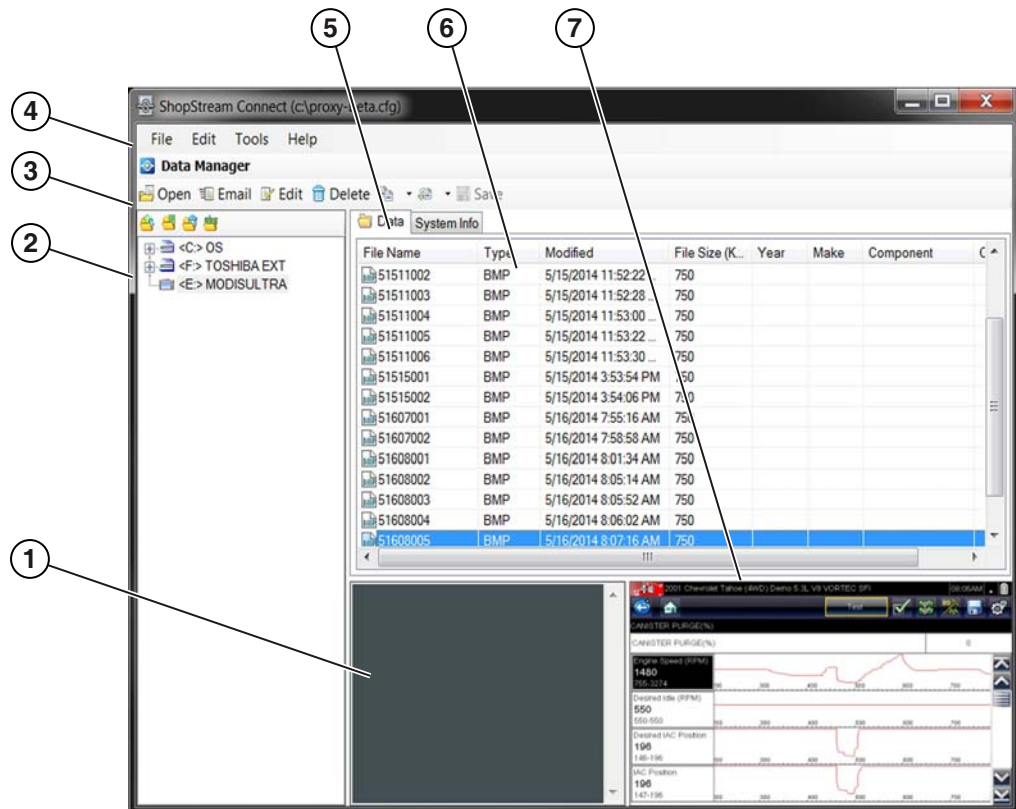

- 1— **Notes Window**—allows you add notes to select data files. Select **Save** from the menu bar to save your notes. *NOTE: Not all file types allow notes, the Notes window will be grayed out when a file type that does not support notes is highlighted. Some image files may display notes for reference purposes (the notes are grayed out and not editable).*
- 2— **File directory structure**—displays the file directory structure of your PC in standard Windows format, and shows any connected diagnostic tools at the bottom of the data list.
- 3— **Data Manager Toolbar**—provides control icons that perform a variety of operations on data files.
- 4— **Main Menu bar**—contains File, Edit, Tools, and Help menus.
- 5— **Tabs**—provides access to data files and presets stored on the diagnostic tool or on the PC, and also allows viewing of software revision details of the diagnostic tool.
- 6— **Main display**—shows stored data files details. *NOTE: The files listed are sortable (ascending/descending) by clicking on the column tab at the top (e.g. File Name, Type, etc.) Sort preferences are saved when the ShopStream Connect program is closed.*
- 7— **Preview**—displays a sample of the file if the selected file is a image file.

Figure 6-1 ShopStream Connect screen layout

6.2 Main Menu Bar

The Main Menu Bar includes the following menu options.

- **File**
- **Edit**
- **Tools**
- **Help**

Descriptions are provided in the following sections.

6.2.1 File Menu

The following functions are available from the **File** menu:

- **Exit**—Closes the ShopStream Connect software.
- **Open File**—This function is used to open data files for viewing. The ShopStream Connect software lets you view data files stored on both the computer and the diagnostic tool. This operation is also available with a right-click of the mouse.
- **Copy to...**—This function creates a duplicate of the selected files at the other location (PC if the file is on the diagnostic tool or diagnostic tool if the file is on the PC). This operation is also available with a right-click of the mouse.
- **Move to...**—This function moves selected files to another location (to the PC from the diagnostic tool, or to the diagnostic tool from the PC). This operation is also available with a right-click of the mouse.
- **Delete**—This function erases the selected files. This operation is also available with a right-click of the mouse.
- **Edit**—Edit lets you quickly change the name of a file, or depending on the file type, add vehicle information and/or rename a data file. This operation is also available with a right-click of the mouse.
- **Email**—This function starts an E-mail message with a copy of file selections attached. This operation is also available with a right-click of the mouse.
- **Refresh File List**—Resamples and cleans up the display screen.
- **Print**—Sends the current screen to a printer.

6.2.2 Edit Menu

The **Edit** menu functions, follow Windows operational standards.

The following functions are available from the **Edit** menu:

- **Cut File(s)**—Removes the selected file and places it on the clipboard.
- **Copy File(s)**—Copies the selected file to the clipboard.
- **Paste File(s)**—Inserts the contents of the clipboard at the current location.

6.2.3 Tools Menu

The Tools menu includes the following options:

- **Update Software**
- **Options**

Update Software

This function allows you to download updates and upgrades for your diagnostic tools and ShopStream Connect software. See [“Updating and Upgrading Software” on page 58](#).

Options

This function allows you to enter shop information to be added to printed files and to change the location of the saved data files on the PC. Selecting **Options** opens a submenu that offers the following:

- **Autostart**—automatically launches ShopStream Connect whenever a diagnostic tool in Connect-to-PC mode is connected to the computer.
- **Edit Shop Info**—allows you to add your shop name and information to printed files.
- **Change ShopStream Data Folder Path**—allows you to select a different target destination for the diagnostic tools folder on your PC.

Autostart

ShopStream Connect automatically launches if a diagnostic tool is in Connect-to-PC mode, or the CF card from a MODIS, SOLUS, or Vantage PRO, is recognized by your PC when Autostart is active. This feature can be switched off and on by selecting it from the options submenu. A check mark alongside the name indicates Autostart is active.

Edit Shop Info

Selecting **Edit Shop Info** opens a dialog box that allows you to enter the name address, and phone number for your shop, which can be included as a header on printed files. The date and time are automatically placed on the top line, and messages of up to three lines can also be added below the shop information. A preview panel at the bottom of the box shows how the information will appear on a print out (Figure 6-2).

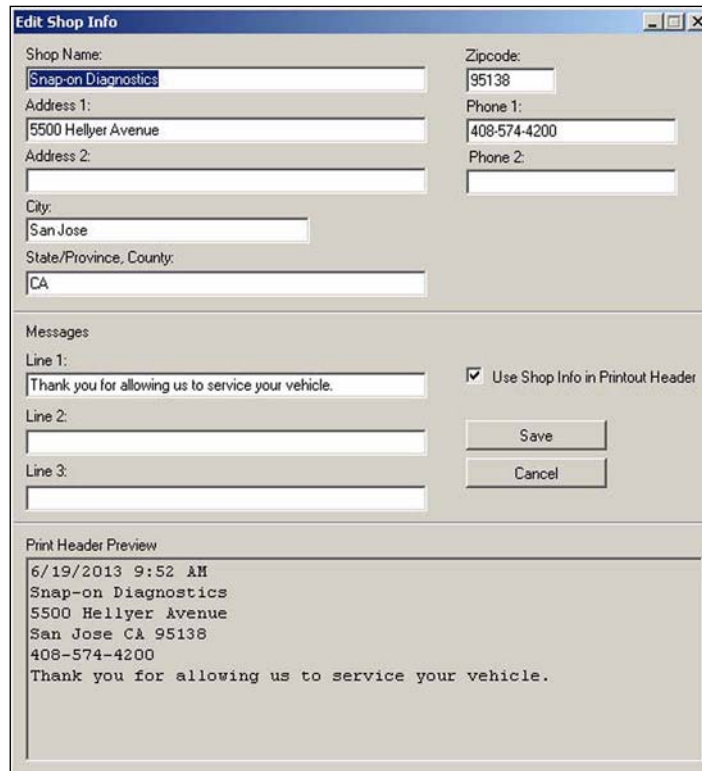

Edit Shop Info

Shop Name: Snap-on Diagnostics

Address 1: 5500 Hellyer Avenue

Address 2:

City: San Jose

State/Province, County: CA

Zipcode: 95138

Phone 1: 408-574-4200

Phone 2:

Messages

Line 1: Thank you for allowing us to service your vehicle. Use Shop Info in Printout Header

Line 2:

Line 3:

Save

Cancel

Print Header Preview

```
6/19/2013 9:52 AM
Snap-on Diagnostics
5500 Hellyer Avenue
San Jose CA 95138
408-574-4200
Thank you for allowing us to service your vehicle.
```

Figure 6-2 *Edit Shop Info dialog box*

Check the **“Use Shop Info in Printout Header”** box to automatically include the header on printed files. Select **Edit Shop Info** from the Options submenu to modify or add messages before printing.

Change ShopStream Data Folder Path

When a diagnostic tool is initially connected to a PC using ShopStream Connect, a diagnostic tool folder is created and named after the connected tool (e.g. ETHOS+, SOLUS, MODIS Ultra, etc).

Selecting **Change ShopStream Data Folder Path** allows you to change the location of the diagnostic tool folder. Selecting this option opens a dialog box that allows you to browse the menu structure on your computer (Figure 6-3). Follow the onscreen instructions to select or create your new “target destination” folder and/or location.

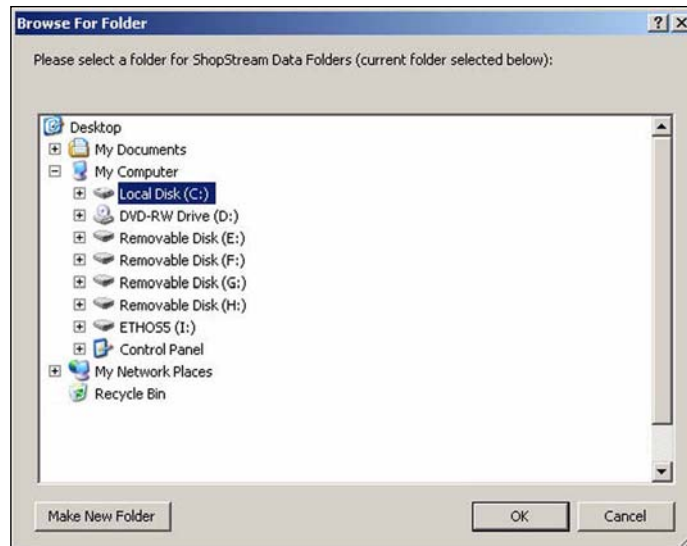

Figure 6-3

6.2.4 Help Menu

The Help menu includes useful information and links to help you get acquainted with and learn how to use ShopStream Connect.

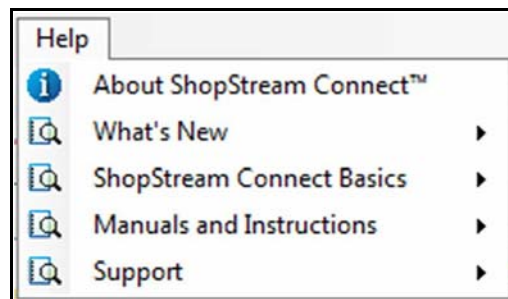

Figure 6-4 Help menu

About ShopStream Connect - Displays ShopStream Connect software version information.

Whats New - Opens a submenu of links to learn about new platform information, accessories and the Subscription Manager Feature.

- ShopStream Connect Subscription Manager Feature (*User Manual Link*).
- What's New in Platform Coverage (*Webpage Link*).
- Optional Platform Accessories (*Webpage Link*).

ShopStream Connect Basics - opens quick links to the following topics in the *User Manual*.

- How to transfer files from diagnostic tool to PC.
- How to view files.
- How to download and install a software service release using Update Manager.
- How to download and install a software upgrade using Subscription Manager.

Manuals and Instructions - opens quick links to the *User Manual* and Installation Instructions.

- ShopStream Connect Installation Instructions (*User Manual Link*).
- ShopStream Connect User Manual.

Support - opens quick links found on the Snap-on Diagnostic webpage.

- ShopStream Connect FAQ's - lists Frequently Asked Questions about ShopStream Connect.
- ShopStream Connect User Forum - connect with other ShopStream Connect users to ask questions and find answers to your questions.
- Customer Support - lists customer support contact information.

6.3 Data Manager Screen Controls and Icons

6.3.1 Display Tabs

Tabs positioned at the top of the ShopStream Connect main display control the visible file information. The active tab is highlighted.

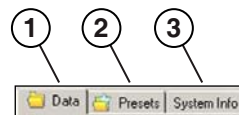

- 1— Data**—displays a list of the data files on the diagnostic tool or stored on the PC.
- 2— Presets**—displays a list of the preset files stored in the diagnostic tool or PC memory. This tab only displays when connected to a diagnostic tool that has presets, such as MODIS or Vantage PRO.
- 3— System Info**—displays the serial number and version number of the connected diagnostic tool.

Figure 6-5 Tabs

Data Tab

A typical ShopStream Connect data screen is shown below:

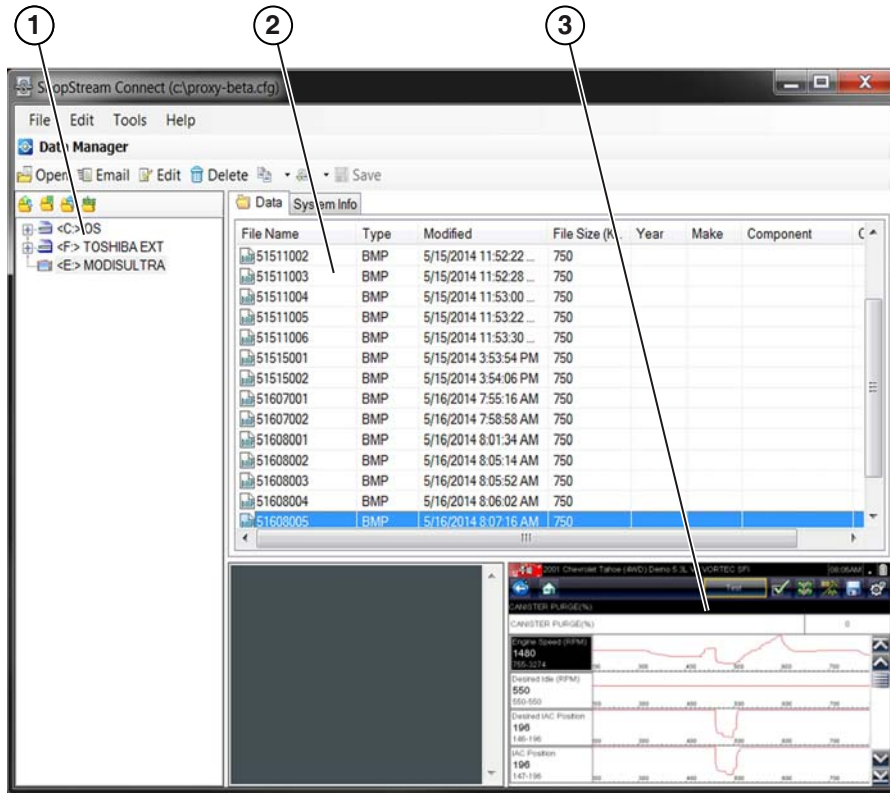

- 1— **File directory structure**—shows the file directory structure in Windows format.
- 2— **Main display**—shows a list of diagnostic tool data stored in the directory selected in the file structure frame.
- 3— **Preview**—shows a sample of the selected image file.

Figure 6-6 Data screen

System Info Tab

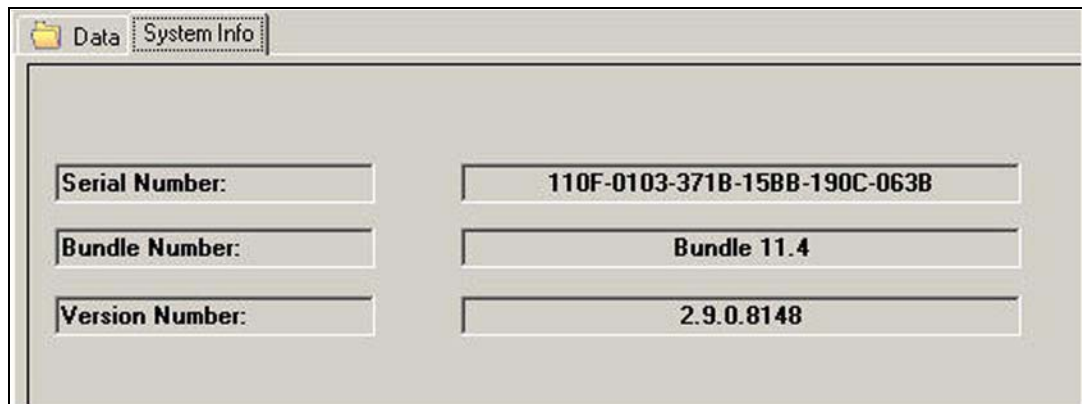

Figure 6-7 System Info Tab

**NOTE:**

The System information tab is only displayed when a diagnostic tool is connected and communicating with the PC. To view the tab, select (highlight) the diagnostic tool (drive) from the file directory structure list as shown in (Figure 6-6).

The System information screen displays details about the currently installed software in the display area of the screen. System information includes:

- **Serial Number**—used to uniquely identify your diagnostic tool.
- **Bundle Number**—used to identify the software release date.
- **Version Number**—used to identify the specific software version.

6.3.2 Controls

A mouse or keyboard can be used to navigate the program.

Using a Mouse

- **Left mouse button:**
 - Select a toolbar control
 - Select an item from a drop-down menu
 - Operate the on-screen arrow keys
- **Right mouse button:**
 - Open the context sensitive menu

Using Drag and Drop

Files stored on the computer may be moved in the file directory structure frame by using Windows-standard drag-and-drop functionality. ShopStream Connect creates individual “Files” folders for each diagnostic tool (e.g. ETHOS, MODIS, MODIS Ultra, SOLUS, SOLUS PRO, Vantage PRO) when the software installs. Drag and drop files from the list to a folder.

Using the Keyboard

- **Left, Right, Up, Down arrow keys:**
 - Move the control selection highlight around the menus and tabs
- Use the **Enter** key to:
 - Activate a selection
- Use the **Esc** key to:
 - Exit a function







6.3.3 Data Manager Toolbar Icons

This section explains toolbar icon operations, refer to “Main Screen Layout” on page 22.



Figure 6-8

The following icons are used in the toolbar:

1		Open	Opens the highlighted file.
2		E-mail	Allows you to send data files by e-mail (if default e-mail is configured).
3		Edit	Allows editing of the data file name, vehicle year, make, component, and condition.
4		Delete	Erases the selected files from diagnostic tool or PC memory.
5		Copy To	Copies data and preset files between the computer and the diagnostic tool internal memory.
6		Move To	Transfers data and preset files between the computer and the diagnostic tool internal memory.
7		Save	Saves the open file. This function is only available after a file has changed.

Open

The ShopStream Connect software lets you to use your computer to view data files stored on both the computer and the diagnostic tool.



To view a file:

1. Select the **Data** tab.
2. Highlight the file that you wish to view.
3. Select **Open** from the toolbar.

The selected file displays on the computer screen (Figure 6-9).

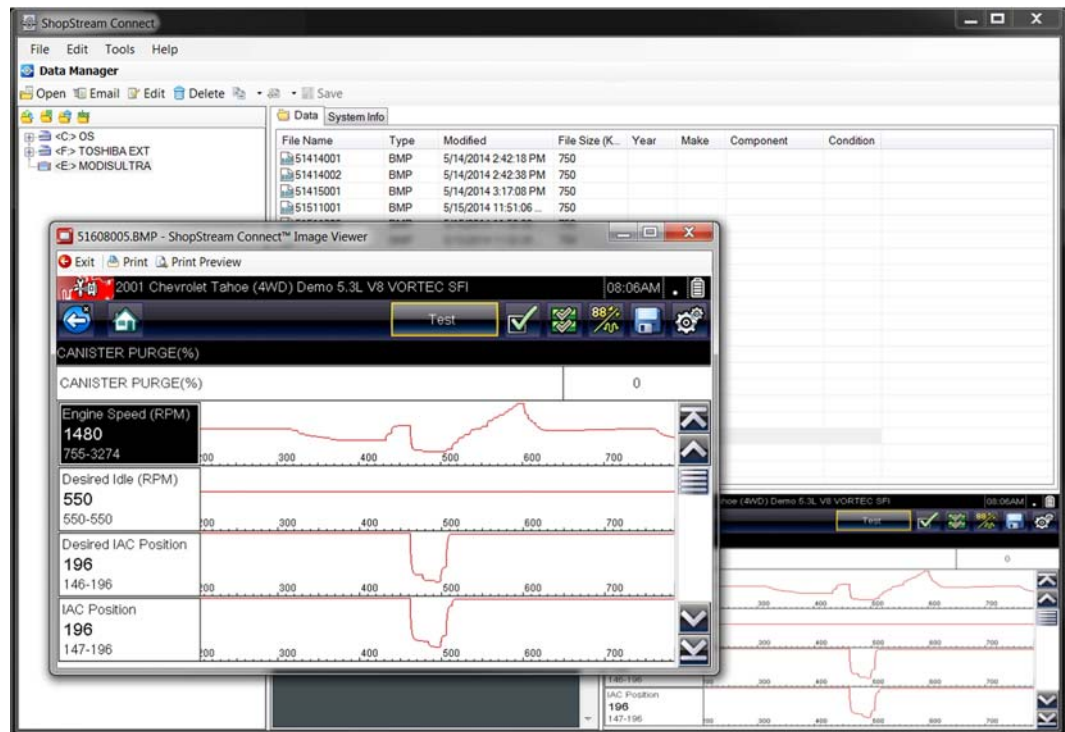

Figure 6-9 BMP file display

**NOTE:**

You can also open a file by selecting **File > Open File** from the File menu or by double-clicking the selected file name.

Email

This function sends a copy of selected files from your PC or diagnostic tool via E-mail.

**NOTE:**

The ShopStream Connect Email feature uses the default e-mail program configured on your computer. If a default e-mail program has not been configured, an error message displays. Default e-mail configuration setup procedures vary depending on your operating system (OS) (e.g. WinXP, Win7, Win10, etc). Review your Windows Help information for default e-mail setup procedures.

**To use the Email function:**

1. Select the **Data** tab.
A list of available files displays.
2. From the on-screen list, highlight the file you wish to send.
3. From the toolbar, select **Email**.
An e-mail message window opens, with the selected file(s) attached.
4. Enter the e-mail address, subject, message text.
5. Select **Send**.

Edit

Edit lets you quickly change the name of an image file, or add vehicle information and rename a data file.



To edit a file:

1. Select the **Data** tab.
2. With the file that you wish to edit highlighted, select **Edit** from the toolbar.
The Edit File Information window opens (Figure 6-10).

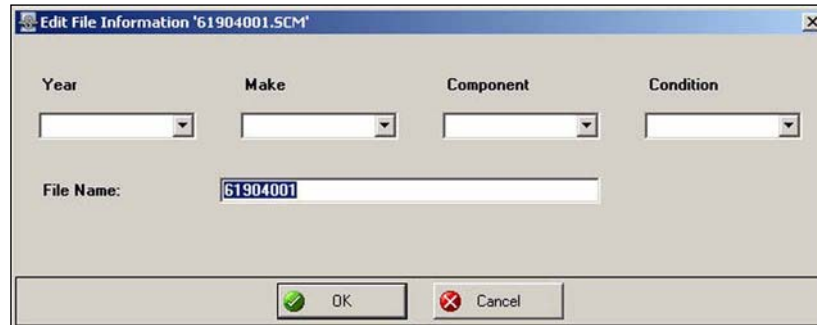

Figure 6-10 Edit File Information window

3. For a data file, either use the dropdown menus to select the year, make, component, and condition, or type in the information.
4. Type in the new name for the file.



NOTE:

File Name is the only editable field, for image file types.

5. Select **OK** to close the window.

Delete

Files stored on the computer are typically sent to the recycle bin on your PC but vary depending on your Windows settings. Files stored in diagnostic tool memory are always permanently deleted.



To delete a file:

1. Select the **Data** tab.
2. Highlight the file that you wish to delete.
3. Select **Delete** from the toolbar.
4. A confirmation screen displays:
 - a. Select **Yes** to permanently erase the file.
 - b. Select **No** to cancel.

Copy To

The **Copy To** function creates a duplicate of the selected file or files on either the PC Data Folder or the diagnostic tool. Depending on where the original files reside, the duplicates copy to the other device. Select **Copy To** and a dropdown menu opens allowing you to choose where the file will be copied to. The original files are still available in the original location.

Move To

Use the **Move To** function to move files between the diagnostic tool and your PC.



To move a file:

1. Select the **Data** tab.
A list of files (if available) displays.
2. From the list, select one or multiple files to move.
3. Select **Move To**.
A dropdown menu displays.
4. Select the location, either PC Data Folder or diagnostic tool.
The selected files move to the selected location.

Save

Saves the open file. This function is only available after a file has changed.

Data and image files can be viewed using the Data Manager Viewers. There are multiple viewers that open the various data and image file extensions saved on diagnostic tools.



NOTE:

File extension types vary depending on the diagnostic tool. Not all the file extensions described here may be available on your diagnostic tool.

- **Scanner DataViewer** - Opens files with the following extensions:
 - .pids - ShopStream Scanner “movie”
 - .scm - Scanner “movie”
 - .scp - Scanner Snapshot
 - .scs - Scanner Screen Snapshot
 - .spm - ETHOS Scanner “movie”
 - .lcm - Microscan Scanner “movie”
- **Scope File Viewer** - Opens files with the following extensions:
 - .ism - Ignition Scope “movie”
 - .isp - Ignition Scope Snapshot
 - .lsm - Lab Scope “movie”
 - .lsp - Lab Scope Snapshot
 - .lss - Lab Scope Screen Snapshot
 - .mmm - Multimeter “movie”
 - .mmp - Multimeter snapshot
 - .mms - Multimeter Screen Snapshot
 - .vsm - Verus Scope “movie”
 - .vss - Verus Scope Screen Snapshot
- **Image Viewer** - Opens files with the following extensions:
 - .bmp - Screen Snapshot (bitmap image file)
 - .jpg - Screen Snapshot (JPEG image file)
 - .sps - Scanner Screen Snapshot
- **Scanner Codes Viewer** - Opens files with the following extensions:
 - .xml - Scanner Code Files

7.1 Scanner DataViewer

Your ShopStream Connect software allows you to view data files recorded with your diagnostic tool on you PC. When a Scanner data file is selected, it opens and displays in the Scanner DataViewer (Figure 7-1). Scanner DataViewer allows you to custom configure the displayed data in a number of ways, and also provides a number of navigation options.

Scanner DataViewer - Opens .pids, .scm, .scs, .scp, .spm, and .lcm file extensions



- 1— Menu bar
- 2— Display toolbar
- 3— Graph display
- 4— Properties icon
- 5— Vertical Scroll bar
- 6— Zoom controls
- 7— Slider bar
- 8— Navigation toolbar
- 9— Parameter text list
- 10—Highlighted PIDs - indicates graphs currently displayed
- 11—Parameter configuration tabs

Figure 7-1 Scanner Data Viewer

7.1.1 Menu Bar

The menu bar at the top of the screen contains the File, View, Tools, and Help menus.

File Menu

The File menu offers the following selections (Figure 7-2):

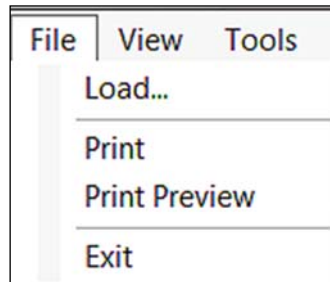

Figure 7-2 Scanner DataViewer File menu

- **Load**—locate and open data files, launches a navigation window
- **Print**—print selected PIDs
- **Print Preview**—preview PIDs before printing
- **Exit**—closes Scanner DataViewer

When Print or Print Preview is selected, a dialog box opens that allows you to choose (Figure 7-3):

- Which PIDs to print
- To print only as a list
- To print only as a screenshot
- How many PIDs graphs print per page
- Printed font

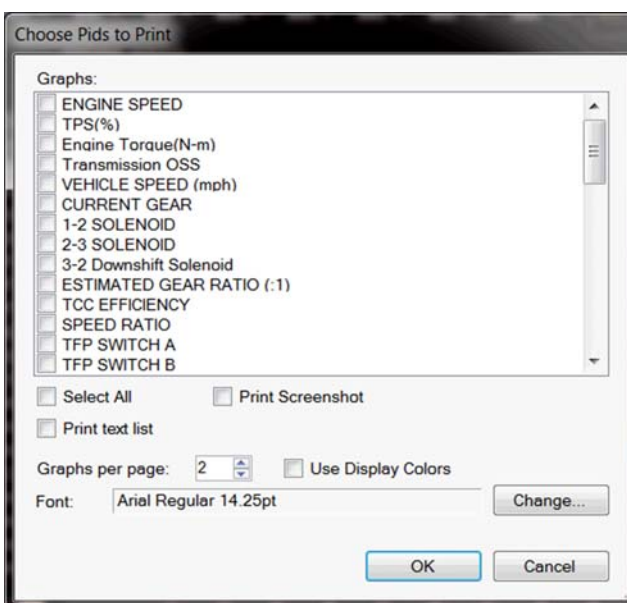

Figure 7-3



To use Print or Print Preview:

1. From the dialog box select the PIDs to be printed. A checked box indicates the PID will be printed.

Use the **Select All** check box to simultaneously select all the PIDs at once.

By default, PID graphs will be printed.

- To print as a PID text list, select the **Print text list** check box.
- To print a screenshot, select the **Print Screenshot** check box.

2. To change the printed font, select **Change**.

3. Once all selections are made, select **OK**.

A standard print dialog box opens.

4. Select **OK** to print.

a. If **Print** was selected, the file is sent to the printer.

b. If **Print Preview** was selected, a preview window opens (Figure 7-4). Select the printer icon to send the file to the printer.

The following examples, show:

- Default PID graphs print preview Figure 7-4 (left)
- PID text list print preview Figure 7-4 (right)
- Screenshot print preview Figure 7-5



Figure 7-4



Figure 7-5

View Menu

The View menu allows you to change how data is displayed on the screen (Figure 7-6).

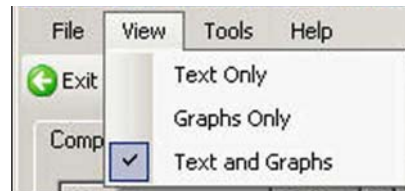

Figure 7-6 Scanner DataViewer View menu

Select from the following menu options:

- **Text Only**—shows all parameters and their values as text only
- **Graphs Only**—shows all parameters as graphs only
- **Text and Graphs**—shows all parameters and their values as text in the left panel of the screen, and shows them as graphs in the right panel of the screen

Tools Menu

The Tools menu allows you opens the Properties dialog box (Figure 7-7).

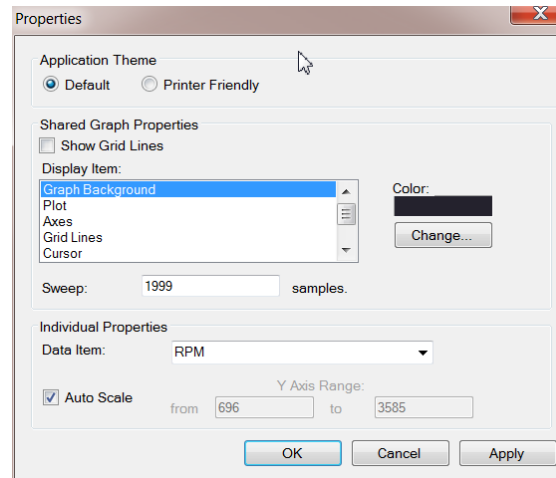

Figure 7-7 Properties dialog box



NOTE:

The Properties icon on each graph also opens the Properties dialog box (Figure 7-7).

The Properties dialog box includes three primary sections:

- **Application Theme**
- **Shared Graph Properties**
- **Individual Properties**

Application Theme

- **Application Theme** - overall graph display properties. There are two settings:
 - **Default** - displays graphs with a black background
 - **Printer Friendly** - displays graphs with a white background.See (Figure 7-8) for examples.

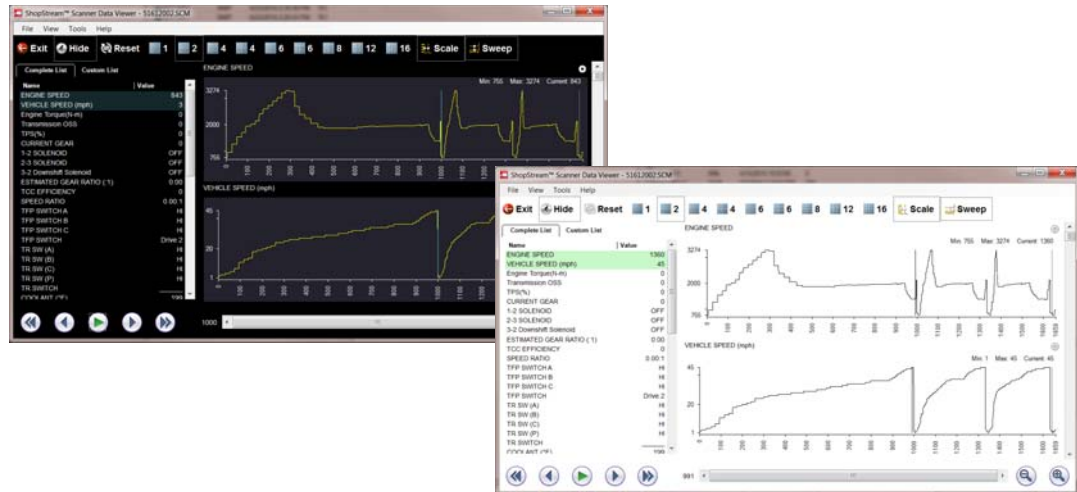

Figure 7-8 View Settings - Default (left) and Printer Friendly (right)

Shared Graph Properties

This section provides settings for all graphs.

- **Show Grid Lines (checkbox)**—when selected, a line displays at each major division of the graphs.
- **Display Item**—used to view the display color of the listed items. Highlight an item, and the associated color appears in the Color box.
 - **Color Change (button)**—use to change the color of the highlighted item, select to open the color palette.
- **Sweep**—enter a number to adjust the number of data frames that appear onscreen (zoom in or out).

Individual Properties

This section provides settings to the selected graph only.

- **Data Item**—use this pulldown menu to select individual graphs for modification.
- **Auto Scale**—minimum and maximum (Y axis) values automatically adjust to the signal when the box is checked, uncheck the box if you want to custom set the values.
- **Y Axis Range**—use to type desired minimum (from) and maximum (to) values in the selection boxes. This field is only active when Auto Scale is deselected.

Dialog Box Control Buttons

- **OK**—applies the changes and closes the properties dialog box.
- **Cancel**—closes the properties dialog box without making changes.
- **Apply**—applies the changes and leaves the properties dialog box open.

Help Menu

The Help menu provides Scanner Viewer software version information.

7.1.2 Display Toolbar

The Display toolbar provides the following controls (Figure 7-9).

- **Exit**—closes Scanner DataViewer.
- **Hide PID List**—toggles display between parameter text and graph views.
- **Reset**—returns the listed parameters to the default sort setting (if previously sorted)
- **Display Views (1 to 16)**—determines how many graphs display at a time.
- **Scale**—switches the scale values shown to the left of the graph off and on.
- **Sweep**—switches the sweep values shown below the graph off and on.



Figure 7-9 Display toolbar

When the window size is too small to display all the toolbar buttons, select **more** to display the hidden options.

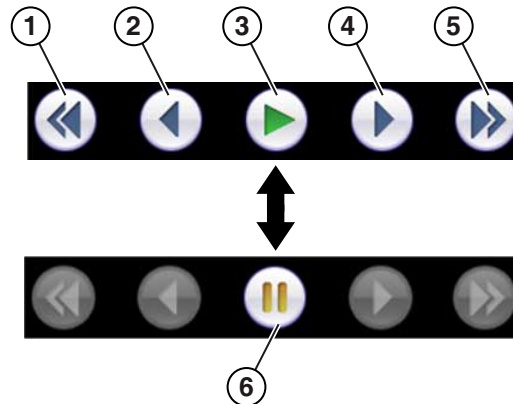

Figure 7-10

7.1.3 Navigation Tools

Playback Controls

The playback controls allow you to navigate through saved data (Figure 7-11).



- 1— **Skip Back**—Allows quick backward movement by graph screen length. Each click moves the cursor to the next screen of data, while the cursor remains at the same screen position in the next screen of data.
- 2— **Step Back**—Allows backward movement in singular steps.
- 3— **Play**—Select to play.
- 4— **Step Forward**—Allows forward movement in singular steps.
- 5— **Skip Forward**—Allows quick forward movement by graph screen length. Each click moves the cursor to the next screen of data, while the cursor remains at the same screen position in the next screen of data.
- 6— **Pause**—Select to pause playback.

Figure 7-11 Playback controls

Zoom Controls

The zoom controls allow you to incrementally increase or decrease the screen magnification (Figure 7-12).



Figure 7-12 Zoom controls

Slider / Scroll Bars and Cursor

Use the slider bar to quickly navigate through the data (Figure 7-13). During playback the number displayed on the left side of the slider bar indicates the current position of the cursor in the data file.

The cursor can be repositioned during playback or when paused, by selecting and dragging, or by double-clicking on the desired new location.

When using the slider bar to navigate through data, the cursor does not move. This allows you to mark a point of interest with the cursor, and search for other data of interest, then go back to the cursor if needed.

Use the scroll bar (right side) to vertically scroll through the parameter list and graphs.

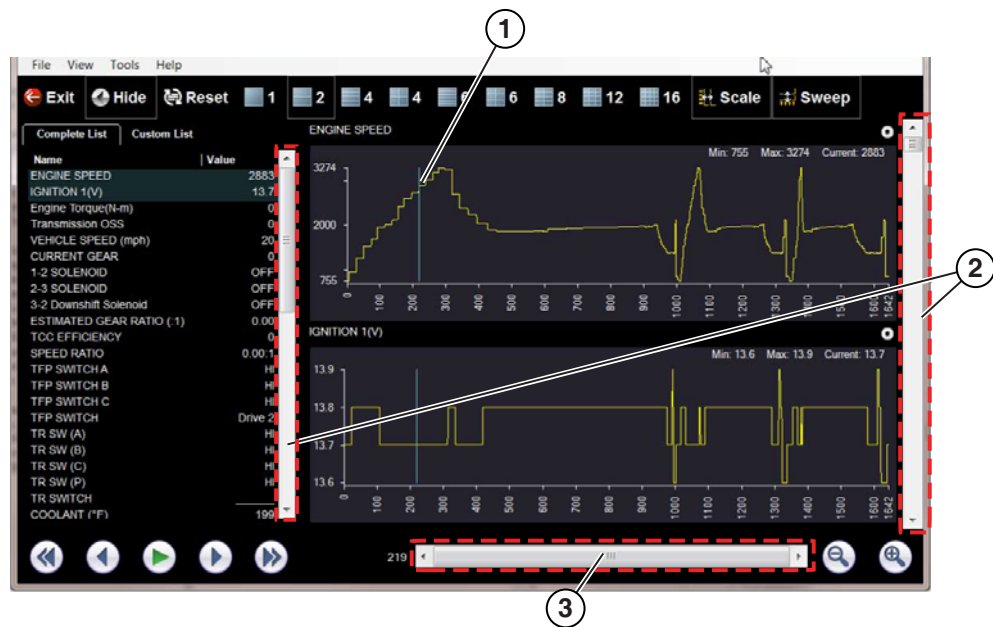

- 1— Cursor
- 2— Scroll bar
- 3— Slider bar

Figure 7-13

7.1.4 Customizing the Display

The parameter text list (left side) displays parameter names and current values.

The display can be customized by selecting and dragging parameters from the text list or graph display to a different location in the text list or in the graph display (Figure 7-14). The highlighted parameters in the text list indicate which parameters are displayed as graphs.



NOTE:

The parameter text list is sortable by name and value. Select Name or Value at the top of the list to change the sorted view. Use the Reset button to reset the list to the default setting.



Figure 7-14

7.1.5 Customizing the Parameter List

The parameter configuration tabs allow you to choose between displaying all available parameters (Complete List), or only those from a (Custom List) (Figure 7-15).

The parameter listed are sortable (ascending/descending) by clicking on the Name and Value tabs at the top of the list.



To customize the parameter list:

1. Select the **Custom List** tab (Figure 7-15).
2. Select **Edit List** in the custom window.

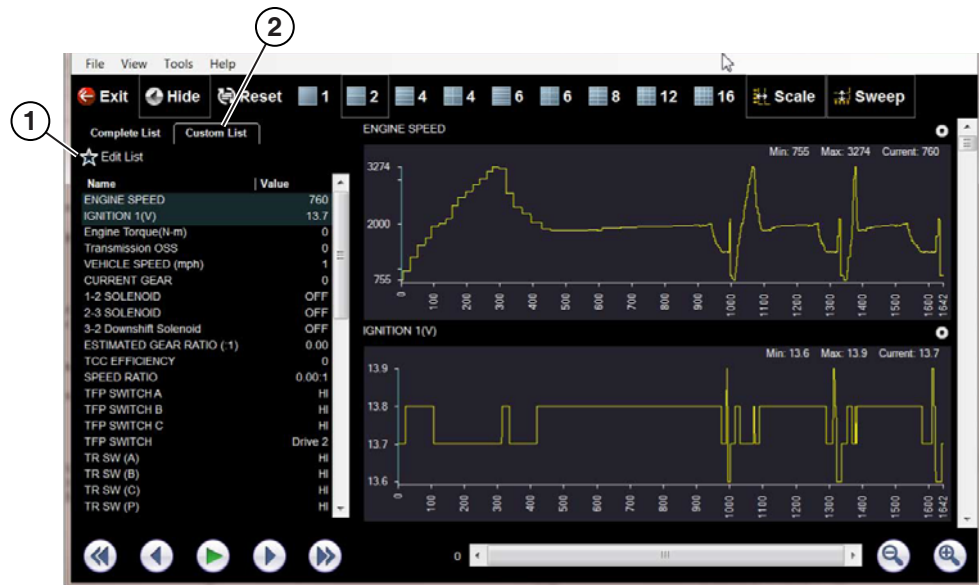

1— Edit List

2— Custom List tab

Figure 7-15

A list of available parameters displays (Figure 7-16).

3. Select the parameters to include in your custom list. Select All and Deselect All controls are also available to assist in the selection process.



Figure 7-16 Creating a custom parameter list

4. Select **Save & Exit** to close the window.
Only the parameters selected in your custom list are displayed.

7.2 Scope File Viewer

Your ShopStream Connect software allows you to print and playback recorded trace signals captured on your diagnostic tool. When a scope file is selected, it opens and displays in the Scope File Viewer.

Scope File Viewer - Opens .ISM, .ISP, .LSM, .LSP, .LSS, .MMM, .MMP, .MMS, .VSM, and .VSS file extensions.



NOTE:

The Scope File Viewer is intended to be used to review scope and meter files originally captured on a diagnostic tool. Some features (control icons) of the Scope File Viewer may not be available "grayed out". This is normal as those features are only applicable when viewing live data on a diagnostic tool.

The Scope File Viewer screen includes the following sections ([Figure 7-17](#)):







- 1— **Toolbar** - contains control icons
- 2— **Main Body** - displays recorded trace results
- 3— **Profile Controls Window** - displays profile control icons and trace display settings
- 4— **Playback Control Toolbar** - contains playback and display controls

Figure 7-17 Scope File Viewer screen layout

7.2.1 Toolbar

The Scope Viewer toolbar includes controls to configure display settings and print traces. The following table provides brief descriptions of the toolbar controls:

Table 7-1

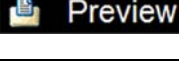
Name	Icon	Description
Setup	 Setup	Opens preferences submenu to setup personal preferences and review captured data settings.
Cursors	 Cursors	Toggles cursor display on/off. Cursors are two vertical rules that can be repositioned on the screen to measure intervals.
Refresh	 Refresh	Not Used - This control is not operational.
File	 File	Opens a dialog box that allows you to select options for saving data.
Print	 Print	Opens a dialog box that allows you to configure and print.
Preview	 Preview	Opens a dialog box that allows you to preview and change page settings before you print.

Setup

Setup includes the following display options for setting preferences to review captured traces.

- **Traces** - shows original captured trace settings. Changes are not allowed, except adjustment of the baseline setting.
- **Sweep** - shows original captured sweep setting. Changes are not allowed.
- **Trigger** - shows original captured trigger setting. Changes are not allowed.
- **View** - allows you to change display settings.
 - **Display** - adjust display information and appearance.
 - **Show Grid** - toggles grid lines on and off.
 - **Invert Colors** - toggles screen background black to white.
 - **Show RPM** - displays RPM display. (Not Used)
 - **Layout** - use to set how many trace display windows are shown and how they display on the screen.
 - **Units** - use to adjust trace display settings.
- **Setup** - shows original captured trace settings.
 - **Units** - shows original captured trace unit setting.
 - **Snapshot** - shows original percentage of how much data was captured after the snapshot was triggered.
 - **Ignition** - shows original captured trace ignition setting.

Cursors

Select **Cursors** from the toolbar to open the Cursors dialog box (Figure 7-18).

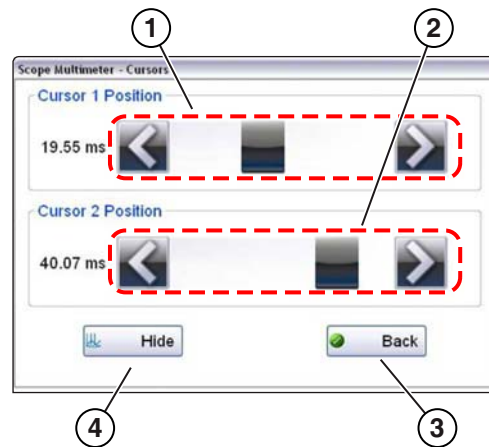

- 1— Cursor 1 controls
- 2— Cursor 2 controls
- 3— Back
- 4— Show or Hide

Figure 7-18 Cursor controls

Cursor 1, the top slider and arrows, is the left-hand cursor on the screen. Cursor 2, the lower set of controls, is the right-hand cursor on the screen. Drag the slider or select the arrows to position the cursors. Each tap of the stylus moves the cursor incrementally in the direction of the arrow.

Select **Show** to display the cursors (the icon changes to Hide).

Select **Hide** to conceal the cursors (the icon changes to Show).

Select **Back** to close the dialog box.

Refresh

This function is not operational in Scope Viewer.

File

Selecting **File** from the toolbar opens a dialog box with a menu of save options:

- **Save Configuration** - allows the current settings to be saved using a different name using the VSC file format. (.VSC files can be viewed by selecting the Presets tab)
- **Save Single Frame** - allows the current screen data to be saved using a different name using the VSS file format. (.VSS files are “single frame” or partial files)
- **Save All Frames** - allows the current file to be saved using a different name using the VSM file format. (.VSM files include “all frames” or complete files)

**To save a file:**

1. Select **File** from the toolbar.
2. Select a Save option from the dialog box.



Figure 7-19 Save options

The Save As dialog box opens.

3. Select the location where you want the file to be saved, and name the file.
4. Select **Save**.

A file description dialog box opens.

**NOTE:**

The description entered here is what displays in the Notes Window panel of the Data Manger main screen.

5. Enter a description of the file.
6. Select **OK**.
7. Select **OK** to close the file setup dialog box.

Print

Selecting **Print** opens dialog box (Figure 7-15). choose one of the following:

- Select **Yes** to print only the Scope window
- Select **No** to print the entire screen

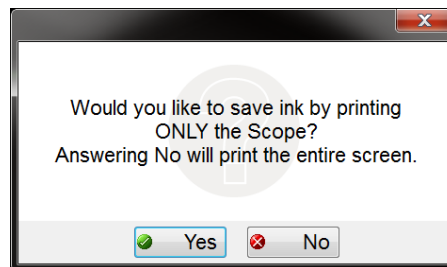

Figure 7-20

A standard Windows Print dialog box opens.

Make the desired print setting selections, then select **OK** to print.

Print Preview

Selecting **Print Preview** opens a print preview window. The Print Preview menu options allow you to adjust the page layout before printing.

7.2.2 Main Body

The main body of the screen varies depending on what display options have been selected. Up to four traces, signal status and triggering conditions can be displayed simultaneously on the main body of the screen.

Each trace is displayed on a standard oscilloscope screen.

- The vertical scale (Y-axis) represents what is being measured (voltage, amperage, pressure etc.), and the unit of measurement it is displayed in.
- The horizontal scale (X-axis) represents time, and the unit of measurement it is displayed in.

Trace adjustments are made from the Toolbar and the Profile Controls window. From the main body you can adjust:

- Cursor position: touch and drag the cursor to reposition it.
- The baseline position (0 value) of the trace can be repositioned on the horizontal scale by touching and dragging the solid bar at the right-side of the channel baseline.

7.2.3 Profile Controls Window



The Profile Controls Window displays the original captured trace profile settings.

Profile	1	2	3	4	Min	Live	Max	Cursor 1	Cursor 2	Delta	Frequency
	20 V	100 V	100 V	40 A				4.48	4.47	0.01	
				100 ms				0.23	0.11	0.13	
								10.83	10.21	0.62	
								4	10	7	
								29.17	66.67	37.50 ms	26.67 Hz

Figure 7-21 Profile Controls Window

Profile settings cannot be changed, except the signal channel Show/Hide settings.

The show/hide trace icons are used to toggle the displayed signal channel off/on.

Show/Hide	Icon	Description
On		Channel displayed
Off		Channel not displayed

Select the icon to toggle the channel off/ on.



NOTE:

Selecting the Channel number from the Profile Control Window opens the Trace Setup dialog box. The Trace Setup dialog box shows the original captured trace settings. Changes are not allowed, except for the zero baseline setting.



NOTE:

Selecting the Trigger indicator from the Profile Control Window opens the Trigger Setup dialog box. The Trigger Setup dialog box shows the original captured trace settings. Changes are not allowed.

7.2.4 Playback Control Toolbar

The playback control toolbar includes navigation controls to review recorded data, change the display view and change the screen magnification.



Figure 7-22 Playback Controls Toolbar

A position counter in the toolbar displays a numerical value of where the current displayed screen is in relation to the entire recorded file.

Use the slider in the middle of the toolbar to quickly move through paused data.

Table 7-2 Data buffer toolbar icons

Name	Icon	Description
Step Back		Allows backward movement in singular steps
Skip Back		Allows backward movement in multiple steps
Stop		Stops playback
Play		Starts playback. Plays the recording in a continuous loop.
Skip Forward		Allows forward movement in multiple steps
Step Forward		Allows forward movement in singular steps
Position Indicator		Numerical playback position indicator
Expand/Collapse		Toggles Main body view between split and full profile views
Zoom		Increases or decreases the magnification of the display

7.3 Image Viewer

The Image Viewer allows you to open and view .bmp, .jpg and .sps image files (screenshots).

**NOTE:**

File extension types vary depending on the diagnostic tool. Not all the file extensions described here may be available on your diagnostic tool.



- 1— **Exit** - closes the Image Viewer
- 2— **Print** - prints the image
- 3— **Print Preview** - allows the image to be previewed before printing
- 4— **Captured Screen Image**

7.4 Scanner Codes Viewer

The Scanner Codes Viewer allows you to view and print XML trouble code files from your diagnostic tool. XML trouble code files can be saved when codes are read from an individual vehicle system or when performing a Code Scan of multiple systems.



NOTE:

XML files are not applicable on all diagnostic tools.

XML file formats vary depending on the diagnostic tool. Examples are shown in the following sections, with descriptions of toolbar functions.

7.4.1 Vehicle System Report Screen

On select diagnostic tools (e.g. MODIS Edge), results are displayed using an enhanced report format, utilizing colors and icons as quick visual indicators of important data.

Vehicle System Report

VEHICLE INFORMATION

MAKE	Peugeot
YEAR	2009
MODEL	407
ENGINE	1.6L 16V T-Diesel (9HZ)
SYSTEM	Engine Management

CODE SCAN RESULTS

Systems Analyzed: 12

- ▲ Engine Management - Codes: 2
- ▲ Transmission - Codes: 3
- ▲ Anti-Lock Brakes - Codes: 1
- ▲ Airbag - Codes: 2
- Alarm - Codes: 0
- ▲ Battery Charge Status Unit (If Fitted) - Codes: 3
- ▲ Climate Control - Codes: 3
- ▲ Electric Steering - Codes: 3
- ▲ Tire Pressure Monitoring - Codes: 2
- ▲ Xenon/ Directional Lights Left - Codes: 3
- ▲ Xenon/ Directional Lights Right - Codes: 3
- ▲ OBDII - Codes: 5

Engine Management

- P0117 | Engine Coolant Temperature Signal, Short Circuit To Earth (Temperature Very High)
- P0112 | Inlet Air Temperature Signal (Flowmeter), Short Circuit To Earth

Transmission

- 0FF2 | Control Unit Fault No Signal
- 0FFF | Configuration Fault No Signal
- U3003 | Battery Voltage

Figure 7-23 Typical - Vehicle System Report Screen

7.4.2 Results Screen

A typical Code Scan results screen is shown below. This screen includes the following toolbar options:

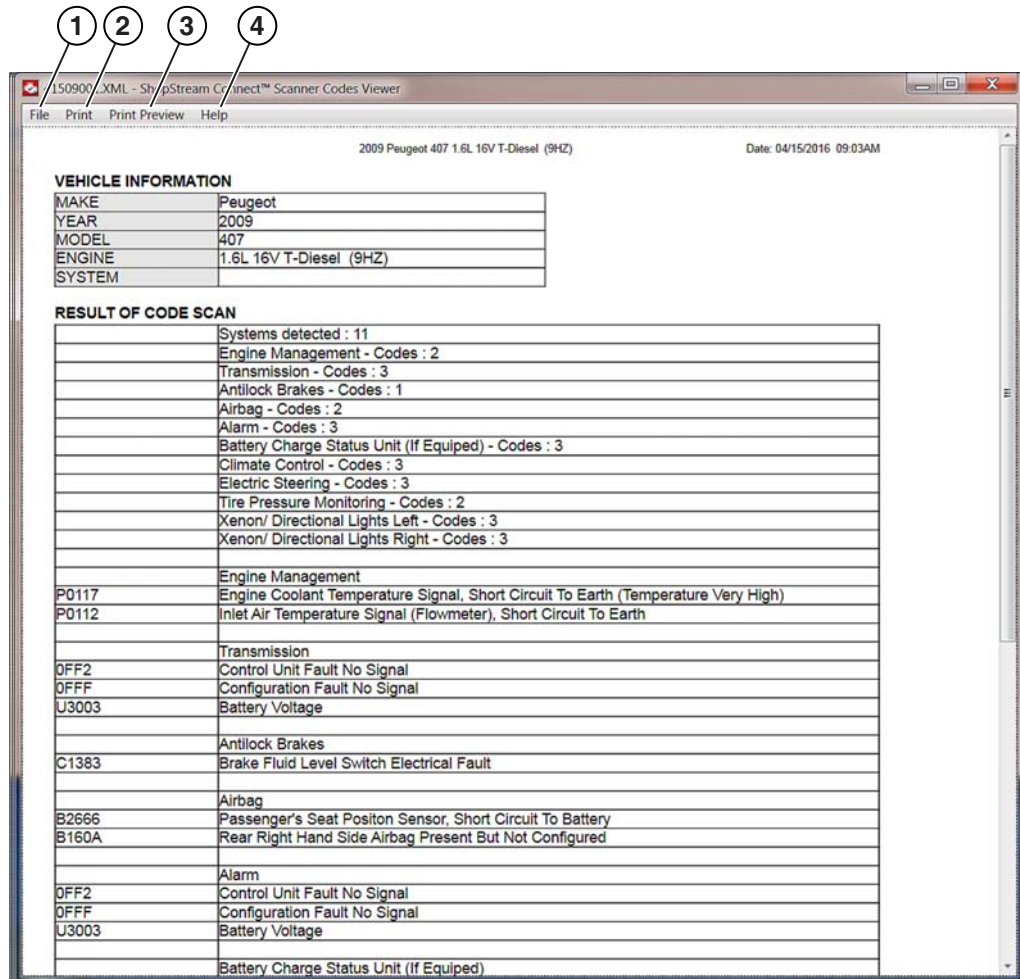

1— **File** - opens the Exit submenu

- **Exit** - closes the Scanner Code Viewer

2— **Print** - prints the XML file

3— **Print Preview** - allows the image to be previewed before printing

4— **Help** - Includes the following submenus

- **About Scanner Codes Viewer** - displays Scanner Code Viewer software version information

Figure 7-24 Scanner Codes Viewer Toolbar

8.1 File Transfer Basics

ShopStream Connect uses a basic Windows interface and familiar copy, paste, move and drag and drop controls to allow you to transfer files bi-directionally between your diagnostic tool and your PC.

To transfer files bi-directionally between your diagnostic tool and your PC, the following basic procedures must be performed:

- Start the ShopStream Connect application, see [“Starting SSC” on page 11](#)
- Connect the diagnostic tool, see [“Connecting the USB Cable and Communicating” on page 13](#)

8.1.1 Folder and Files

When a diagnostic tool is connected to your PC using ShopStream Connect, a diagnostic tool folder is created on your PC named after the platform (e.g. Vantage PRO, MODIS Ultra, etc). This folder allows you to store and transfer files.

The location of the diagnostic tool “target destination” folders on your PC is defined during the installation of ShopStream Connect. The “target destination” folder names and location can be changed at anytime by choosing (from main menu) **Tools > Options > Change ShopStream Data Path**. Follow the onscreen instructions to create or rename your new “target destination” folder and/or location. See [“Change ShopStream Data Folder Path” on page 25](#) for additional information.

8.1.2 Displaying Files

From the ShopStream Connect Main Screen, you can display the File Directory Structure (left side) which shows folders on your PC and the diagnostic tool (if connected to PC). The Data tab on the Main Display, displays only ShopStream Connect compatible files within the folders.

- To display data files on your diagnostic tool, select your diagnostic tool from the File Directory Structure window (e.g. <E> MODISULTRA) and files stored on the diagnostic tool are displayed in the Data tab on the Main Display window.

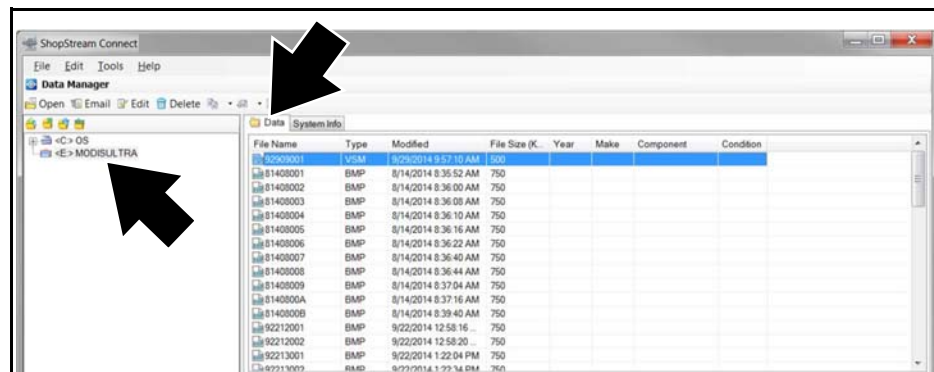

Figure 8-1

- To display data files on your PC, select your “target destination” folder from the File Directory Structure window (e.g. <C> ShopStream \ MODIS Files) and the files stored on your PC are displayed in the Data tab on the Main Display window. See “[Data Manager Screen Controls and Icons](#)” on page 27 for additional information.

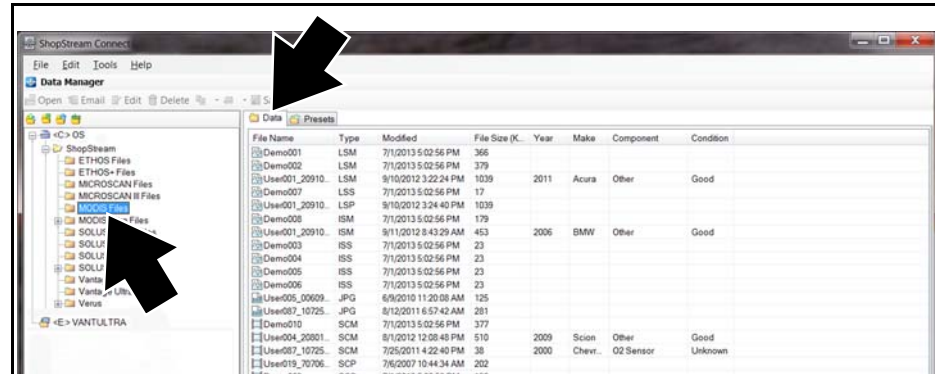

Figure 8-2

**NOTE:**

If the optional “Autostart” control is activated, whenever you connect your diagnostic tool (or memory card) to your PC, the ShopStream Connect software on your PC will automatically recognize your diagnostic tool and open the ShopStream Connect interface. The “Autostart” feature can be turned on or off by selecting or deselecting it from the options submenu **Tools > Options > Autostart**. A check mark alongside “Autostart” indicates the feature is active, see “[Autostart](#)” on page 24 .

From the ShopStream Connect Main Screen, you can also transfer files bi-directionally between your diagnostic tool and your PC using the following methods:

8.1.3 Copying Files

The “Copy To” and “Copy Files” functions create a duplicate of the selected file or files on either the PC or the diagnostic tool. These controls are available from the Main Menu Bar, Data Manager Toolbar or by selecting the file and right clicking and choosing from the dropdown menu. See “[Copy To](#)” on page 32 for additional information.

8.1.4 Moving Files

The “Move To” function moves the selected file or files to either the PC or the diagnostic tool. These controls are available from the Data Manager Toolbar or by selecting the file and right clicking and choosing from the dropdown menu. See “[Move To](#)” on page 32 for additional information.

Files can also be moved by selecting the file and using the Windows-standard drag-and-drop functionality. Simply select the file (left click mouse button and hold) and drag the file to the desired location in the File Structure Directory and drop it (release left mouse button).

8.1.5 Alternate Method

Files and folders can also be moved, copied and renamed using the standard Windows Explorer interface. Select files and folders from within Windows Explorer and move, copy, delete or rename using the standard Windows controls.

Updating and Upgrading Software

This chapter describes procedures for downloading and installing SSC software updates, and diagnostic tool software (service releases), and upgrades (new software versions):

- [Software Updates for ShopStream Connect](#)
- [Software Updates \(Service Releases\) for Diagnostic Tools](#)
- [Software Upgrades for Diagnostic Tools](#)

There are two software update/upgrade methods:

- **Automatic Method** — When a compatible Snap-on diagnostic tool is connected to a PC using ShopStream Connect (SSC), the SSC software will automatically check for updates/upgrades and provide installation instructions. Follow the screen prompts to accept, download and install the software.
- **Manual Method** — To manually check for software updates/upgrades select **Tools > Update Software**, then select either **ShopStream Connect** or your diagnostic tool (**diagnostic tool type - e.g. MODIS, SOLUS PRO, Vantage Pro etc.**) from the Menu bar.

The following procedures are described using the manual method. The automatic method navigation procedures are the same, except the initial Tools menu selection is not needed as the program checks for updates/upgrades automatically.



Initial Steps:

Perform the following initial steps before proceeding.

1. On your PC start the SSC software program.
2. Connect the AC/DC power adapter to the diagnostic tool (if applicable). It is highly recommended to power the tool using the adapter during any update or upgrade procedure.
3. Connect your diagnostic tool to the PC. See the applicable instructions for connecting and establishing communication your diagnostic tool to a PC. See, [“Connecting the USB Cable and Communicating” on page 13](#).



NOTE:

The SSC software must be able to access the Internet on your PC.

9.0.1 Software Updates for ShopStream Connect



Updating ShopStream Connect software:

1. Select **Tools > Update Software > ShopStream Connect** from the Menu bar (Figure 9-1).

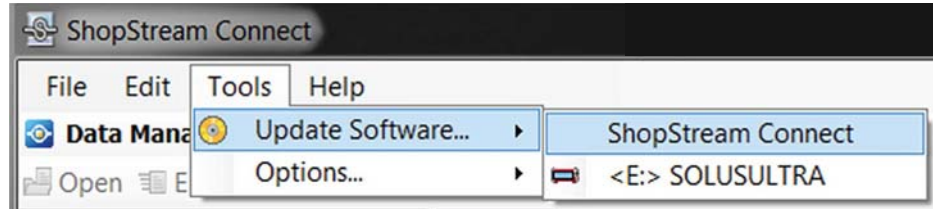

Figure 9-1

The software checks the Snap-on Web server for available updates.

2. If updates are available, select **Next** to continue, then select **Download** and follow the on-screen instructions to complete the installation (Figure 9-2).

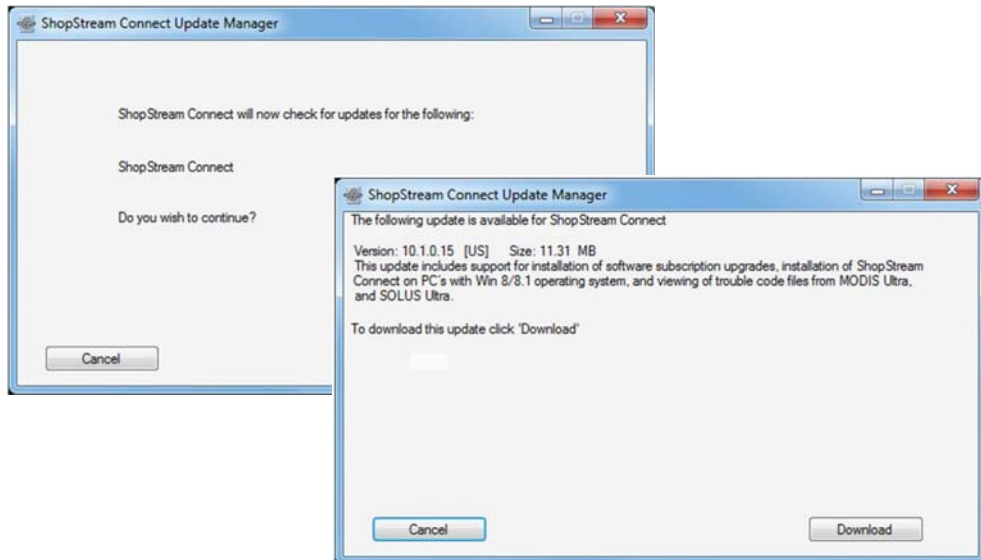

Figure 9-2

9.0.2 Software Updates (Service Releases) for Diagnostic Tools



Updating diagnostic tool software:

1. Select **Tools > Update Software > (diagnostic tool type - e.g. MODIS, SOLUS PRO, Vantage Ultra etc.)** from the Menu bar (Figure 9-3).

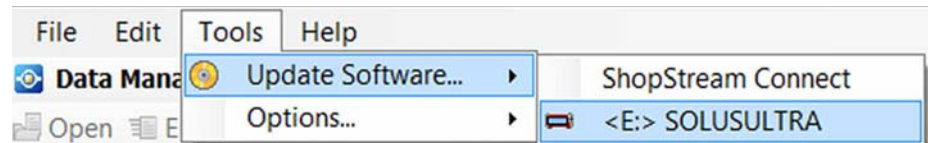

Figure 9-3

The software checks the Snap-on web server for available updates.

2. If service release updates are available, select **Next** to continue, then select **Download** and follow the on-screen instructions to complete the installation (Figure 9-4).

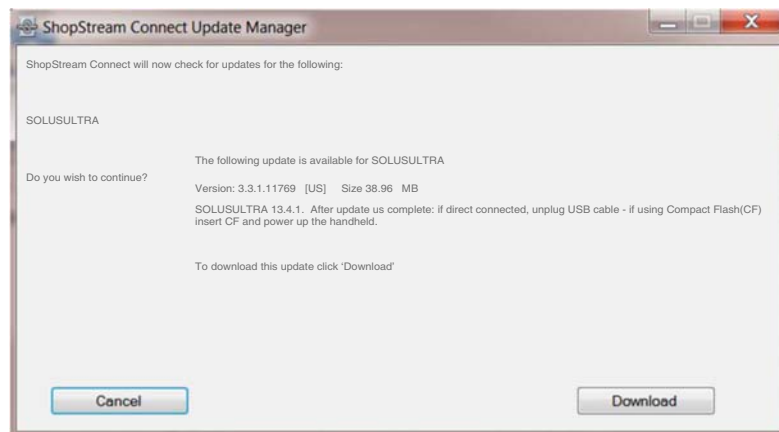

Figure 9-4

9.0.3 Software Upgrades for Diagnostic Tools



Upgrading diagnostic tool software:

1. Select **Tools > Update Software > (diagnostic tool type - e.g. MODIS, SOLUS PRO, Vantage Ultra etc.)** from the Menu bar (Figure 9-5).

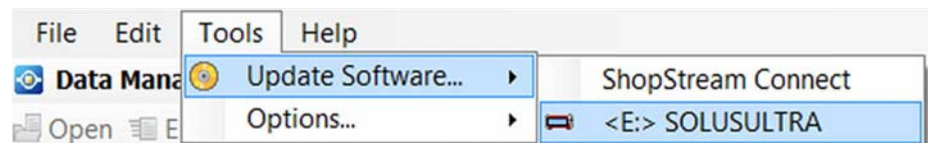

Figure 9-5

- If the diagnostic tool is authorized to receive software upgrades and one is available, an upgrade window is displayed (**see step 2**).
- If the diagnostic tool is authorized to receive software upgrades and already has the latest software, the following message will be displayed “ShopStream Connect did not find any updates”.

- If the diagnostic tool is not authorized to receive software upgrades, SSC software will automatically check the Snap-on web server for a Service Release update. If a Service Release update is available, an update window is displayed. Follow the screen prompts to install the Service Release update.
2. Read and follow the instructions displayed in the message box, then select **Install** to begin the download and installation (Figure 9-6).



NOTE:

Selecting **Upgrade Detail** automatically connects to the Snap-on web server and opens a PDF file with information about the new upgrade.

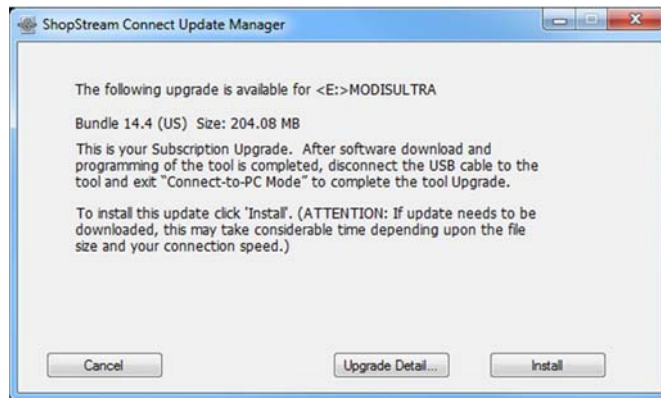

Figure 9-6

The Online Update status window is displayed (Figure 9-7).

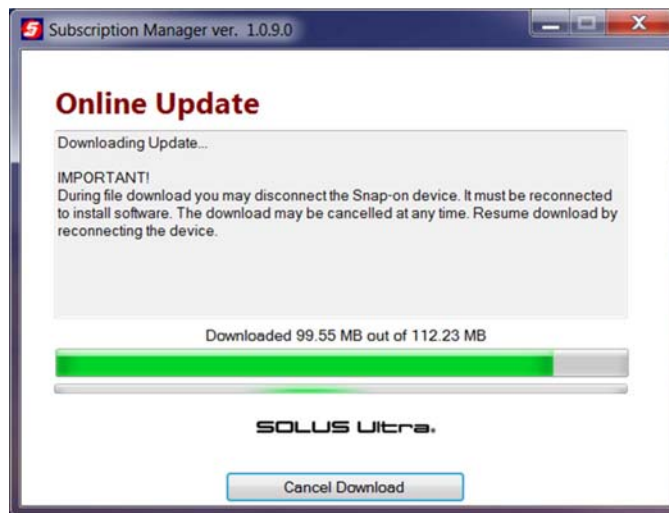

Figure 9-7

3. After the download is complete, the installation confirmation message is displayed. Select **Continue** to proceed with the software upgrade installation (Figure 9-8).

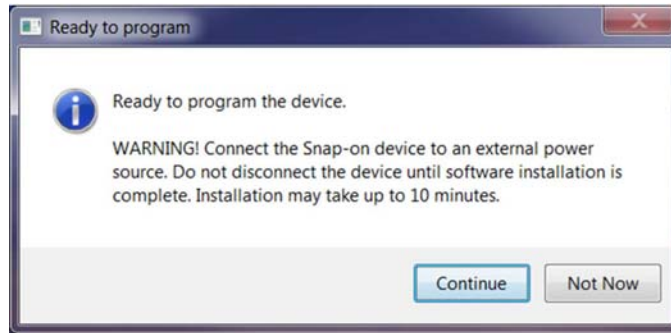

Figure 9-8

The Programming status window is displayed until programming is completed. Once programming is completed select **Exit**, then restart the diagnostic tool (Figure 9-9).

IMPORTANT:

Do not disconnect or remove the diagnostic tool during programming.

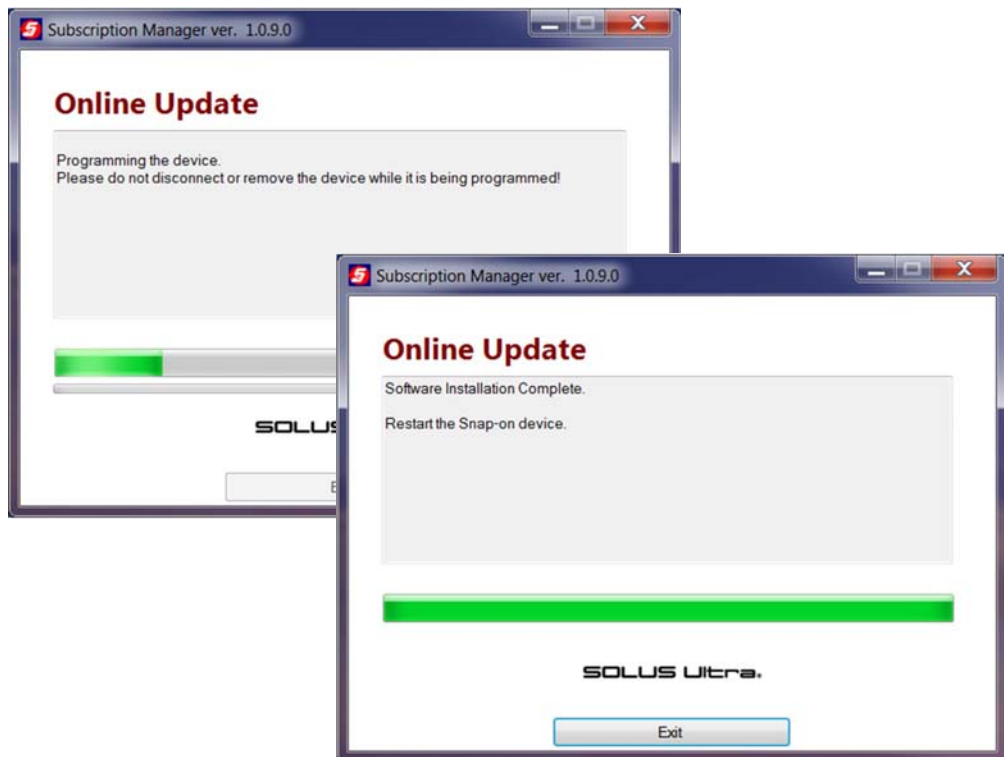

Figure 9-9

Communicating with Early MODIS diagnostic tools

The original MODIS printed circuit board design did not have a Mini-b USB port by the side CompactFlash® (CF) card slot. Therefore, these diagnostic tools cannot be directly linked to a computer with a USB cable. However, it is possible to view files stored on an early MODIS with the ShopStream Connect™ software, it just requires a few extra steps.

A.1 Viewing Early MODIS Files

A CF card reader that connects to your personal computer (PC) is required to view early MODIS files. The CF reader is a standard item that may be purchased from most computer and office supply retailers.



To view early MODIS files:

1. Turn off the MODIS diagnostic tool.
2. Remove the CF card from your MODIS.
3. Connect the CF card reader to your PC and insert the MODIS CF card.
4. If a “removable disk” dialog automatically opens on your PC, select **Cancel**.
5. Launch ShopStream Connect.

ShopStream Connect should recognize the CF card as a MODIS and show it as an available selection in the directory tree. If not:

- a. Open the CF card through Windows®.
- b. Open the User folder, then open the Data folder.
A list of saved data files displays.
- c. Copy the files you want to view in ShopStream Connect.
- d. Open the target folder (C:\Documents and Settings\All Users\Application Data\ShopStream\MODIS Files) on your computer.
- e. Paste the files into the target folder.

These files are now ready for viewing with ShopStream Connect.

IMPORTANT:

Do not change or alter files in any of the other locations on the CF card, as this could impact the operation of your MODIS diagnostic tool

A.2 Service Releases and early MODIS diagnostic tools



To deliver service releases to early MODIS diagnostic tools:

1. Turn off the MODIS diagnostic tool.
2. Remove the CF card from your MODIS.
3. Connect the CF card reader to your PC and insert the MODIS CF card.
4. If a “removable disk” dialog automatically opens on your PC, select **Cancel**.
5. Launch ShopStream Connect.
6. ShopStream Connect should recognize the CF card as a MODIS and show it as an available selection in the directory tree.
7. Select the MODIS from the directory tree.

Refer to [“Software Updates \(Service Releases\) for Diagnostic Tools”](#) on page 60 to complete the update.