

SOLUS^{PRO}

User Manual

August 2009

ZEESCGB316B Rev. A

Trademarks

Snap-on, Sun, SOLUS, and Scanner are trademarks of Snap-on Incorporated, registered in the United States and other countries.

All other marks are trademarks or registered trademarks of their respective holders.

Copyright Information

©2009 Snap-on Incorporated. All rights reserved.

Disclaimer of Warranties and Limitation of Liabilities

The information, specifications and illustrations in this manual are based on the latest information available at the time of printing. While the authors have taken due care in the preparation of this manual, nothing contained herein:

- Modifies or alters in any way the standard terms and conditions of the purchase, lease, or rental agreement under the terms of which the equipment to which this manual relates was acquired.
- Increases in any way the liability to the customer or to third parties.

Snap-on reserves the right to make changes at any time without notice.

IMPORTANT:

Before operating or maintaining this unit, please read this manual carefully paying extra attention to the safety warnings and precautions.

Visit our websites at:

snapon.com (North America)

snapondiag.com (United Kingdom)

sun-diagnostics.com (United Kingdom)

For Technical Assistance Call

1-800-424-7226 (North America)

CALL +44 (0) 845 601 4736 (United Kingdom)

E-mail DiagnosticsUKproductsupport@snapon.com (United Kingdom)

For technical assistance in all other markets, contact your selling agent.

Safety Information

For your own safety and the safety of others, and to prevent damage to the equipment and vehicles upon which it is used, it is important that these Safety Messages be read and understood by all persons operating, or coming into contact with, the equipment.

This product is intended for use by properly trained and skilled professional automotive technicians. The safety messages presented throughout this manual are reminders to the operator to exercise extreme care when using this test instrument.

There are many variations in procedures, techniques, tools, and parts for servicing vehicles, as well as in the skill of the individual doing the work. Because of the vast number of test applications and variations in the products that can be tested with this instrument, we cannot possibly anticipate or provide advice or safety messages to cover every situation. It is the automotive technician's responsibility to be knowledgeable of the system being tested. It is essential to use proper service methods and test procedures. It is important to perform tests in an appropriate and acceptable manner that does not endanger your safety, the safety of others in the work area, the equipment being used, or the vehicle being tested.

It is assumed that the operator has a thorough understanding of vehicle systems before using this product. Understanding of these system principles and operating theories is necessary for competent, safe and accurate use of this instrument.

Before using the equipment, always refer to and follow the safety messages and applicable test procedures provided by the manufacturer of the vehicle or equipment being tested. Use the equipment only as described in this manual.

Read, understand and follow all safety messages and instructions in this manual, the accompanying safety manual, and on the test equipment.

Safety Message Conventions

Safety messages are provided to help prevent personal injury and equipment damage. All safety messages are introduced by a signal word indicating the hazard level.

DANGER

Indicates an imminently hazardous situation which, if not avoided, will result in death or serious injury to the operator or to bystanders.

WARNING

Indicates a potentially hazardous situation which, if not avoided, could result in death or serious injury to the operator or to bystanders.

CAUTION

Indicates a potentially hazardous situation which, if not avoided, may result in moderate or minor injury to the operator or to bystanders.

Safety messages contain three different type styles.

- Normal type states the hazard.
- Bold type states how to avoid the hazard.
- Italic type states the possible consequences of not avoiding the hazard.

An icon, when present, gives a graphical description of the potential hazard.

Example:



Risk of unexpected vehicle movement.

- **Block drive wheels before performing a test with engine running.**
A moving vehicle can cause injury.

Important Safety Instructions

For a complete list of safety messages, refer to the accompanying safety manual.

SAVE THESE INSTRUCTIONS

Contents

Safety Information	iii
Contents	v
Chapter 1: Using This Manual	1
Conventions.....	1
Bold Text.....	1
Symbols	1
Terminology	2
Notes and Important Messages	2
Procedures.....	2
Additional Manuals	3
Chapter 2: Introduction	4
Functional Description	4
Technical Specifications	6
The Stand	7
Control Buttons.....	8
N/X Button.....	9
Y/✓ Button.....	9
Thumb Pad	9
Brightness/Contrast Button	9
S Button	9
Power Button	9
Connections.....	10
DC Power Input.....	10
Mini USB Port	10
USB Port	10
Data Cable Connector	10
Power Supply	10
Vehicle Power	11
Battery Pack.....	11
AC/DC Power Supply.....	12
Cables	12
Data Cable	13
Auxiliary Power Cables	13
Chapter 3: Getting Started	14
Demonstration Mode	14
Supplying Power.....	15
Connecting to Vehicle Power	15
Using the Battery Pack.....	16
Connecting the AC/DC Power Supply	18
Powering On the Unit	19
Setting Up to Print	19

Connecting to a Computer.....	20
Powering Off the Unit	20
Adjusting Brightness and Contrast	20
Chapter 4: Navigation	22
Screen Layout	22
Upper Toolbar	22
Buffer Bar	24
Main Body	24
LED Indicators	25
Status Bar	25
Making Selections	25
Using Easy Scroll	26
Screen Messages.....	26
Confirmation Messages.....	26
Warning Messages.....	26
Error Messages	26
Chapter 5: Operations.....	27
Selecting the Manufacturer.....	28
Identifying the Vehicle	28
Selecting a System.....	29
Connecting to a Vehicle.....	29
Selecting from the System Main Menu.....	30
Using the Scanner Functions	30
Data Display.....	31
Codes Menu.....	31
Functional Tests.....	33
Generic Functions	33
Terminating Vehicle Communication	34
Exiting Scanner Mode.....	34
Viewing Data Graphically	34
Changing Screen Views.....	34
PID List View.....	35
Text View	38
Graph View	38
Pausing Data	43
Clearing the Data Buffer	43
Sorting the Data	43
Using Cursors	44
Using Zoom.....	44
Saving Captured Data	45
Viewing Saved Data	47
Identifying Saved Files.....	48
Loading Saved Files	49
Editing Saved Data	49
Reviewing Saved Data.....	49
Deleting Saved Files	50
Copying and Moving Saved Data	50
Selecting All Files.....	51

Viewing Saved Data Information.....	51
Setting a Destination for Saved Data.....	52
Printing	52
Tools Button	53
Custom Setup	53
Save Data	54
Custom Data List	54
LED Setup.....	55
Utilities.....	55
Tool Setup.....	56
System Tools	61
Easy Scroll	61
Connect to PC.....	62
Run	62
Shop Info.....	62
System Info	63
Chapter 6: Maintenance	64
Cleaning and Damage Inspection	64
Battery Pack	64
Replacing the Battery Pack.....	64
Storage Tips	64
Disposing of the Battery Pack	65
Replacing the Display Window	65
Appendix A: Frequently Asked Questions.....	66
Can I use my other Snap-on® test adapters with this scan tool?.....	66
What should I do if my printer is not responding?	66
What should I do if the unit doesn't respond as expected when I press the Power button?	66
Why does my unit shut down unexpectedly?	67
Appendix B: Troubleshooting	68
No Communication Message	68
Battery Pack Not Charging	68
Unit Will Not Power On.....	69
Forced Shutdown	69
Beep Codes.....	69
Appendix C: Downloading and Installing Software Updates	70
Check for Service Upgrades Before Use.....	70
Verifying Minimum PC Requirements.....	70
Verifying PC System Properties.....	71
Downloading and Installing ShopStream Connect	71
Downloading Service Upgrades	73
Before You Begin.....	74
Installing a Service Upgrade	74
Index	77

This manual contains tool usage instructions.

Some of the illustrations shown in this manual may contain modules and optional equipment that are not included on your system. Contact your sales representative for availability of other modules and optional equipment.

1.1 Conventions

The following conventions are used.

1.1.1 Bold Text

Bold emphasis is used in procedures to highlight selectable items such as buttons and menu options.

Example:

- Press the **Y/✓** button.

1.1.2 Symbols

Different types of arrows are used.

The “greater than” arrow (>) indicates an abbreviated set of selection instructions.

Example:

- Select **Utilities > Tool Setup > Date**.

The example statement abbreviates the following procedure:

1. Navigate to the **Utilities** button.
2. Use the Thumb Pad to navigate to and highlight the **Tool Setup** submenu.
3. Use the Thumb Pad to navigate to and highlight the **Date** option from the submenu.
4. Press **Y/✓** to confirm the selection.

The solid arrows (◀, ▶, ▼, ▲) are navigational instructions referring to the four directions of the Thumb Pad.

Example:

- Press the down ▼ arrow.

1.1.3 Terminology

The term “select” means highlighting a button or menu item using the Thumb Pad and pressing the **Y/✓** button to confirm the selection.

Example:

- Select **Reset**.

The above statement abbreviates the following procedure:

1. Navigate to and highlight the **Reset** button.
2. Press the **Y/✓** button.

1.1.4 Notes and Important Messages

The following messages are used.

Notes

A NOTE provides helpful information such as additional explanations, tips, and comments.

Example:

**NOTE:**

For additional information refer to...

Important

IMPORTANT indicates a situation which, if not avoided, may result in damage to the test equipment or vehicle.

Example:

IMPORTANT:

Do not force the CompactFlash[®] card into the slot.

1.1.5 Procedures

An arrow icon indicates a procedure.

Example:

**To change screen views:**

1. Select the **View button**.
The drop-down menu displays.
2. Select an option from the menu.
The screen layout changes to the format you selected.

1.2 Additional Manuals

This tool works in conjunction with other software products. All of the required manuals are included on the *Diagnostic User Documentation CD*, which was supplied with your scan tool kit. See the appropriate manual for information regarding these products.

The scan tool uses Vehicle Communication Software to provide vehicle-specific trouble codes for various vehicle control systems such as engine, transmission, antilock brake system (ABS) and more, selected functional tests, and troubleshooting information. The scan tool can also graph live data parameters on-screen.



Figure 2-1 SOLUS PRO™

2.1 Functional Description

Figure 2-2, Figure 2-3, and Figure 2-4 show the external features of the scan tool.

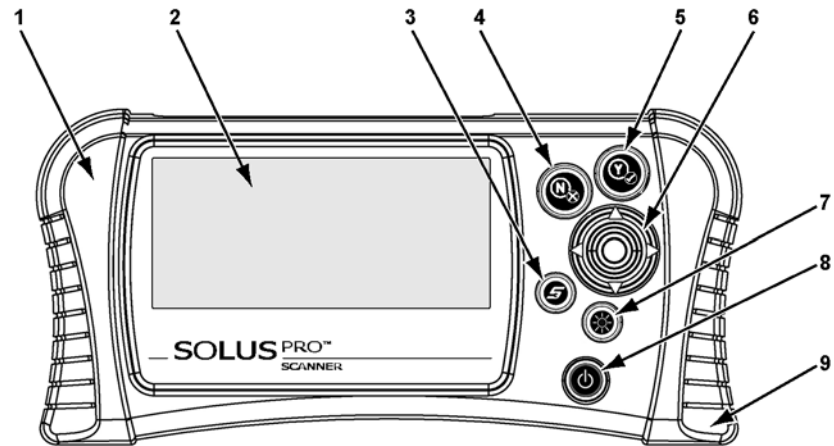

- 1— Left handgrip
- 2— Liquid Crystal Display (LCD)
- 3— S button
- 4— N/X (No) button
- 5— Y/✓ (Yes) button
- 6— Thumb Pad
- 7— Brightness/Contrast button
- 8— Power button
- 9— Right handgrip

Figure 2-2 *Front view*

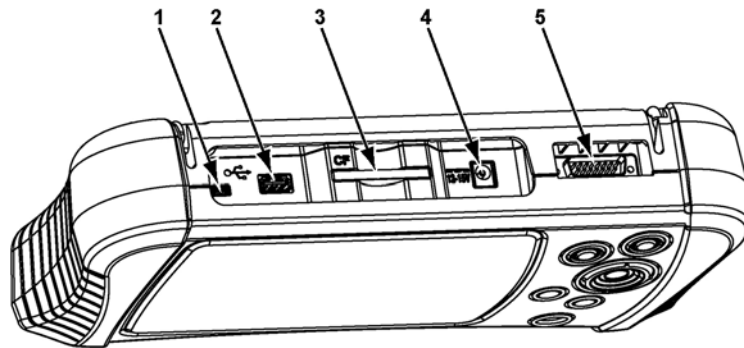

- 1— Mini USB port
- 2— USB port
- 3— CompactFlash® (CF) Card Slot
- 4— DC power supply input
- 5— Data cable connector

Figure 2-3 *Top view*

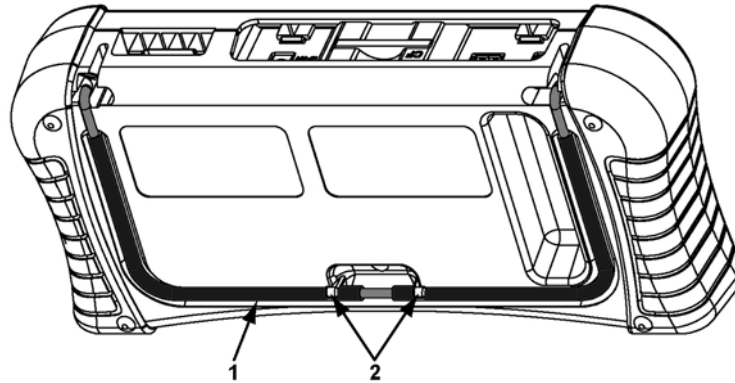

- 1— Stand
2— Casing hook

Figure 2-4 Back view

2.2 Technical Specifications

Display:

Liquid Crystal Display (LCD)
640 x 240 resolution
256 colors
6.2 inches (157.5 mm)

CompactFlash® Card Slot:

The data storage CF card

IMPORTANT:

Never remove the CF card while saving data. Doing so will result in lost data.

Battery Pack:

Nickel-metal hydride
Rechargeable
Weight:
15.4 oz
437 g

External Battery Charger:

Input: 14.5–15.5 VDC, 18 watts
Output: 0–12 VDC, 1.5A

AC/DC Power Supply:

Input: 100–240 VAC @ 0.5A, 47–63 Hz
Output: 12 VDC @ 1.2A

Weight:

With battery pack:

3.37 lbs

1528 g

Dimensions:

Width:

11.85 inches

301 mm

Height:

5.63 inches

143 mm

Depth:

2.56 inches

65 mm

Operating Temperature Range:

14 to 104°F

-10 to 40°C

Storage Temperature Range:

-4 to 149°F

-20 to 65°C

Communication Protocols

Your SOLUS PRO™ scan tool supports the following OBD-II/EODB communications protocols:

SAE J1850 (VPW)

SAE J1850 (PWM)

ISO 9141-2

ISO 14230-4 (KWP 2000)

ISO 15765-4 (CAN)

In addition, the vehicle communications software allows you to access “enhanced” diagnostic information for specific North American, Japanese, and Korean vehicle manufacturers.

2.3 The Stand

The scan tool has a built-in, metal stand attached to the back. When the stand is not in use, it is secured to the back of the unit by an integrated casing hook (Figure 2-4 on page 6).

When extended, the stand allows the unit to rest at a 45° angle for hands-free viewing (Figure 2-5).

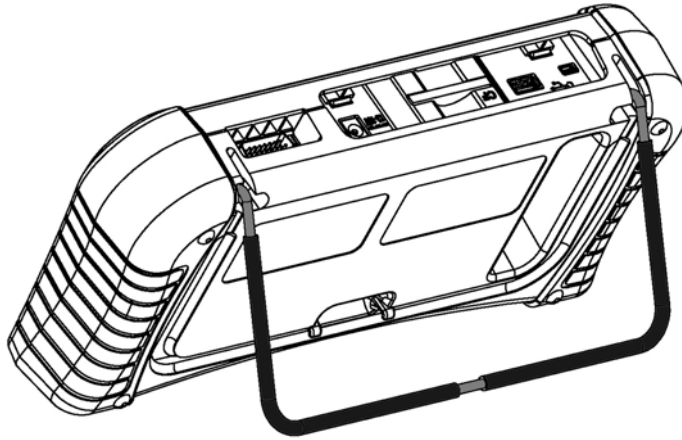

Figure 2-5 *Stand extended*

The stand can also be extended to a hanging position by pressing the left side towards the right and rotating forward (Figure 2-6).

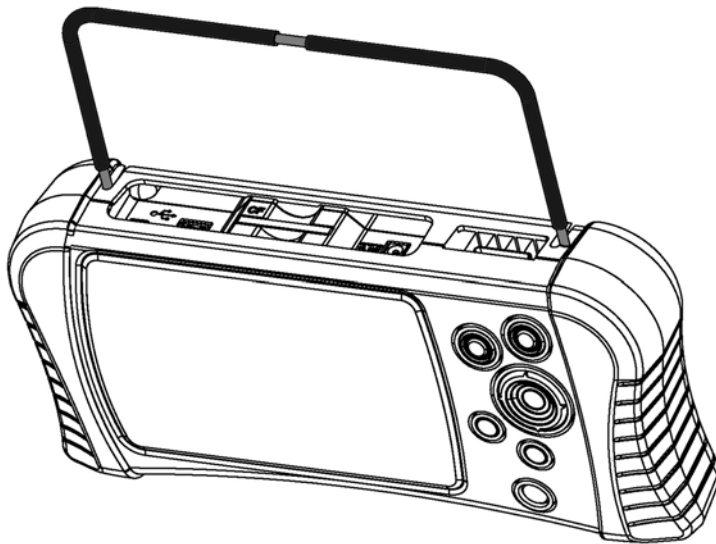

Figure 2-6 *Stand in hanging position*

2.4 Control Buttons

This scan tool has the following control buttons (Figure 2-2 on page 5):

- No (**N/X**) button
- Yes (**Y/✓**) button
- Thumb Pad
- Brightness/Contrast button
- S button
- Power button

2.4.1 N/X Button

The **N/X** button is used to do the following:

- To exit a menu or program.
- To close an open list and return to the previous menu.
- To answer “No” when a Yes or No choice is given.
- To return to the main menu.

2.4.2 Y/✓ Button

The **Y/✓** button is used to do the following:

- To select the item you highlighted using the Thumb Pad.
- To answer “Yes” when a Yes or No choice is given.

2.4.3 Thumb Pad

The **Thumb Pad** moves the highlight, allowing vertical and horizontal on-screen movement. The Thumb Pad is typically used in combination with the **Y/✓** and **N/X** buttons.

2.4.4 Brightness/Contrast Button

The **Brightness/Contrast** button opens the dialog box that allows you to adjust the screen for optimum viewing. See “Adjusting Brightness and Contrast” on page 20 for details.

2.4.5 S Button

The **S** button can be customized to perform different functions from the Utilities > Tool Setup menu. See “S Button” on page 59 for details.

2.4.6 Power Button

The **Power** button powers on and powers off this scan tool. See “Powering On the Unit” on page 19 and “Powering Off the Unit” on page 20 for details.

The Power button is also used to force the scan tool to shut down. This feature should only be used if the tool is not performing correctly, such as the display locks-up or data is not updating.



To perform a forced shutdown:

1. Press and hold down the **Power** button for five seconds.
2. The scan tool sounds a series of beeps, then turns off.
The unit can now be restarted.

2.5 Connections

This scan tool uses the following connections (Figure 2-3 on page 5):

- DC power adapter input
- Mini USB port
- USB port
- Data cable connector

2.5.1 DC Power Input

The AC/DC power supply provides power to the scan tool through the DC power input on top of the unit (Figure 2-3 on page 5). For related information, see the following sections:

- “AC/DC Power Supply” on page 12
- “Connecting the AC/DC Power Supply” on page 18

2.5.2 Mini USB Port

This scan tool has a Mini USB port for connecting the scan tool to a PC.

2.5.3 USB Port

This scan tool has a USB port for connecting computer peripherals, such as a printer, a keyboard, or a mass storage device.

2.5.4 Data Cable Connector

The connector on the data cable attaches to adapters that in turn attach the scan tool to a vehicle for testing.

For related information, see the following sections:

- “Cables” on page 12
- “Connecting to Vehicle Power” on page 15

2.6 Power Supply

This scan tool can receive power from three sources:

- Vehicle power
- Battery pack (rechargeable)
- AC/DC power supply

For related information, see “Supplying Power” on page 15.

2.6.1 Vehicle Power

This scan tool can receive 12V vehicle power via the data cable either by itself or in conjunction with the optional auxiliary power cables.

For related information, see the following sections:

- “Data Cable Connector” on page 10
- “Cables” on page 12
- “Connecting to Vehicle Power” on page 15

2.6.2 Battery Pack

The scan tool can be powered by a rechargeable nickel-metal hydride battery pack installed in the unit behind the right handgrip (Figure 2-7).

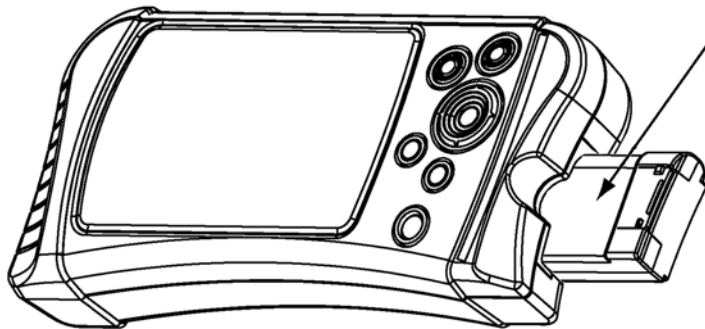

Figure 2-7 Battery pack partially removed

The internal battery allows you to power the scan tool, identify the test vehicle, and view the connection message prior to connecting the scan tool to the vehicle. The connection message lets you know which cable adapters and keys are used to connect to the vehicle, and also provides the location of the vehicle data link connector (DLC). Once connected to the vehicle scan tool power must be provided either through the DLC or by the auxiliary power cables when performing vehicle tests or accessing data. A no communication message displays if vehicle power is not available to the scan tool.

IMPORTANT:

A fully-charged battery pack should be installed in the scan tool whenever you are testing a vehicle, even though the scan tool can operate on vehicle power without the battery installed. The battery pack compensates for voltage drops caused by engine cranking.

Battery Charger

The battery pack is recharged by an external battery charger (Figure 2-8). See “Using the Battery Pack” on page 16 for information on charging and installing the battery pack.

The battery charger uses the same AC/DC power supply that can also be used to power the scan tool. See “AC/DC Power Supply” on page 12 for more details.

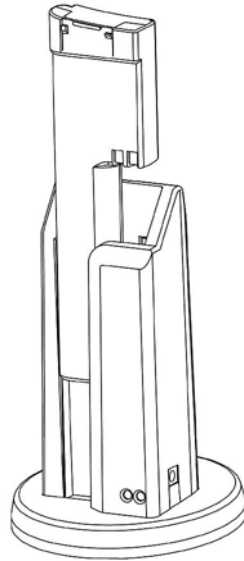

Figure 2-8 Battery and battery charger

2.6.3 AC/DC Power Supply

This scan tool can be powered from a wall socket using the AC/DC power supply (Figure 2-9). The AC/DC Power Supply provides a constant 12V, and must be used when updating the scan tool software to prevent accidental power loss. The power supply also helps preserve battery life during operations that do not require a connection to the vehicle, such as using Demonstration mode or reviewing and managing saved data files.

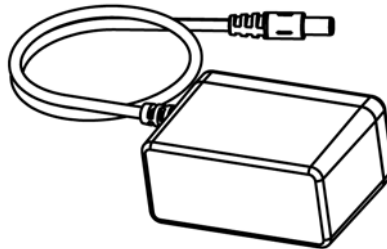

Figure 2-9 AC/DC power supply

For related information, see the following sections:

- “DC Power Input” on page 10
- “Connecting the AC/DC Power Supply” on page 18

2.7 Cables

This scan tool uses the following cables:

- Data cable
- Auxiliary power cables, lighter and battery, optional.

2.7.1 Data Cable

The data cable (Figure 2-10) is included with your scan tool and uses interchangeable test adapters for connecting to vehicle diagnostic connectors.

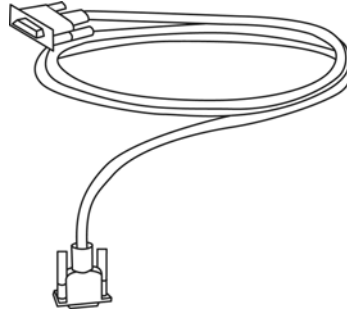

Figure 2-10 *Data Cable*

Captive screws secure the data cable ends to the scan tool and test adapter. An optional data cable extension is available.

2.7.2 Auxiliary Power Cables

Two auxiliary power cables, the Lighter Power Cable (Figure 2-11) and the Battery Power Cable (Figure 2-12), are available as an option. The auxiliary cables are used for testing vehicles without battery power on the diagnostic connector.

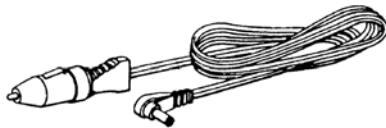

Figure 2-11 *Lighter Power Cable*

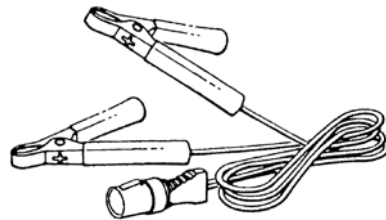

Figure 2-12 *Battery Power Cable*

Refer to the *Accessory Guide*, included with your kit, for a complete listing of accessories and replacement parts.

The following steps get you started using the scan tool:

1. Familiarize yourself with SOLUS PRO™ controls and connections. Refer to “Control Buttons” on page 8 for details.
2. Charge the battery. Allow two to three hours for charging. Refer to “Using the Battery Pack” on page 16 for details.



NOTE:

Use battery power for Vehicle identification purposes only (example: locate the data link connector (DLC) and identify the adapter and keys required for vehicle communication). Always operate your SOLUS PRO™ with the battery pack installed.

3. When fully charged insert the battery pack in the battery slot. See “To install the battery pack:” on page 18 for details.
4. Press the **Power** button to turn the scan tool on.
Once the tool is powered up, you can use Demonstration mode to become familiar with scan tool navigation and functionality without connecting to a vehicle.

3.1 Demonstration Mode

The scan tool contains programs to demonstrate scan tool test capabilities without actually connecting to a vehicle. Sample vehicle data with mock test results are provided to help you become familiar with menus, navigation, and basic operations.



To use the EOBD demonstration:

1. Highlight EOBD on the scan tool Main Menu and press **Y/✓**.

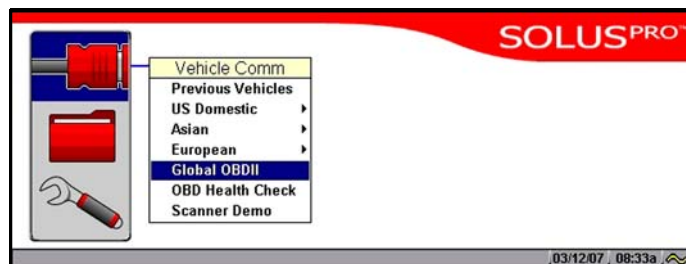

Figure 3-1 Global OBD-II/EOBD menu selection

2. Press **Y/✓** to open the EOBD database.
3. Highlight **OBD Training Mode** and press **Y/✓**.

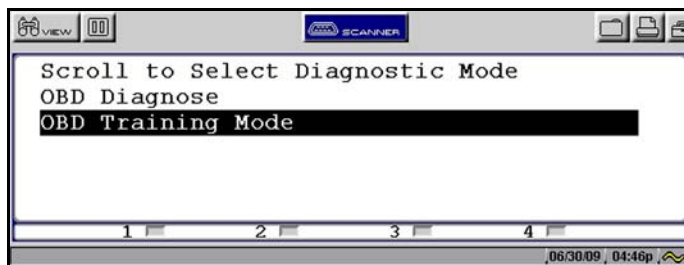

Figure 3-2 Sample OBD Training Mode selection

4. Highlight **Start Communication** on the Main Menu OBD, and Press **Y/✓** to select.
5. Press **Y/✓** when the vehicle connection message displays.
6. The ECU/Protocol Information screen displays, Press **Y/✓** to continue.
7. Highlight any of the item on the Select Service menu, and Press **Y/✓** to select. Simulated test data now displays.
8. To exit, press **N/X** until you return to the Main Menu OBD.
9. Highlight **End of Diagnose** at the bottom of the list and press **Y/✓**.
10. Highlight the **View** button on the upper toolbar and press **N/X** to return to the Main Menu.

3.2 Supplying Power

There are three ways to supply power to the scan tool:

- Connect to vehicle power
- Use the battery pack
- Connect to an AC adapter

For related information, see “Power Supply” on page 10.



NOTE:

To extend the life of your battery pack, always power the scan tool with vehicle power or use the AC/DC Power Supply. The battery pack is intended to be used during the vehicle identification process and to get vehicle connection information.

3.3 Connecting to Vehicle Power

You need the following to connect the scan tool to vehicle power:

- Data cable
- Test adapter

For related information, see the following sections:

- “Data Cable Connector” on page 10
- “Vehicle Power” on page 11
- “Connecting to Vehicle Power” on page 15

To connect to vehicle power:

1. Connect one end of the data cable to the data cable connector on the top of the scan tool (Figure 2-3 on page 5).
2. Connect the other end of the data cable to the appropriate test adapter. The scan tool displays relevant adapter and key usage for the identified vehicle.
3. Connect the test adapter to the vehicle diagnostic connector. The scan tool displays the location of the diagnostic connector.
4. Turn the ignition on.

For vehicles that do not supply power through the diagnostic connector, you must use the optional auxiliary power cables (see “Auxiliary Power Cables” on page 13).

NOTE:

Do not plug the Lighter Power Cable into the DC power input port on the top of the unit. Vehicle power must be supplied to the test adapter for the scan tool to communicate with the vehicle.

To use auxiliary power cables:

1. Connect the required test adapter to the data cable (Figure 3-3).

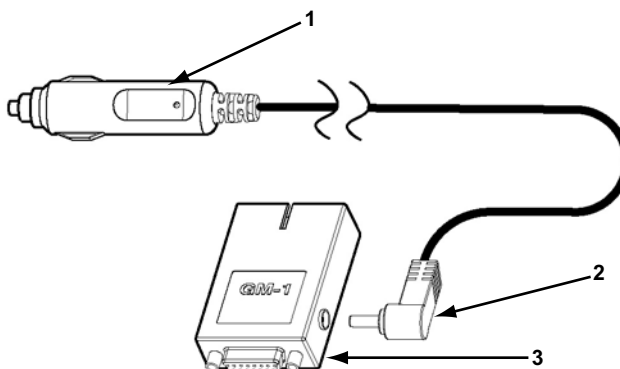

- 1— Lighter Power Cable, large end
 2— Lighter Power Cable, small end
 3— Vehicle test adapter

Figure 3-3 Auxiliary power cable connections

2. Plug the small end of the Lighter Power Cable into the port on the test adapter.
3. Plug the large end of the Lighter Power Cable into the socket of the Battery Power Cable.
4. Connect the clamps of the Battery Power Cable to the vehicle battery. Be sure to observe correct polarity when connecting to the vehicle battery.

3.4 Using the Battery Pack

The scan tool comes with a rechargeable nickel-metal hydride battery pack and an external battery charger.

For related information, see the following sections:

- “Battery Pack” on page 11

- “Battery Charger” on page 11
- “Replacing the Battery Pack” on page 64
- “Battery Pack Not Charging” on page 68

Before using the battery pack for the first time, you must fully charge it.



To charge the battery pack:

1. Remove the battery from the scan tool:
 - a. Remove the right handgrip from the scan tool.
 - b. Press down on the retaining tab on the side of the battery pack and slide the battery pack out of the battery slot.
2. Plug the AC/DC power adapter into the DC power jack of the battery charger.



NOTE:

Do not put a hot battery pack in the battery charger unit. Allow the battery pack to cool first. For optimal battery charging, the ideal room temperature is 77°F (25°C) ±5°.

3. Vertically insert the battery pack into the charger (Figure 3-4).

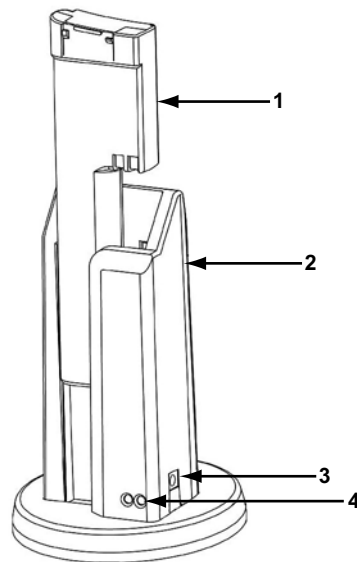

- 1— Battery pack
- 2— Battery charger
- 3— DC power jack
- 4— Charge status light

Figure 3-4 Battery pack charge orientation

When charging begins, a red status light displays.

4. Let the battery pack charge until a steady green status light displays.

When the battery pack is too hot, too cold, or unable to hold a charge, both red and green charge status lights will flash. If the charge status lights flash for more than two hours, the battery pack may need replacing. See “Battery Pack Not Charging” on page 68.

**NOTE:**

A fully discharged battery pack takes four hours to charge.

**To install the battery pack:**

1. Remove the right handgrip.
2. Insert the battery pack into the battery slot (Figure 3-5).
3. Replace the handgrip.

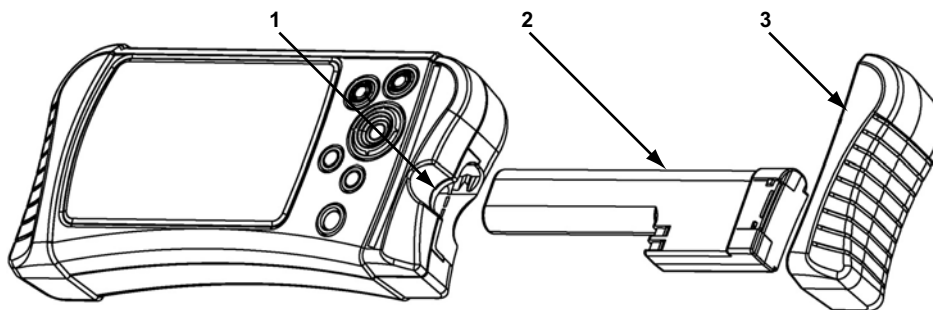

- 1— Battery slot
 2— Battery pack
 3— Right handgrip

Figure 3-5 Battery pack installation

**To extend the life of the battery pack:**

- Before recharging the battery pack, let it become completely discharged. A warning message displays four minutes before the battery pack is completely discharged.

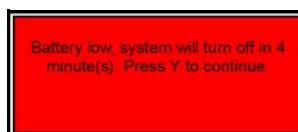

Figure 3-6 Sample low battery warning

**To continue working after the battery warning displays:**

- Connect the AC/DC power adapter.

The scan tool may not be able to communicate with the vehicle if 12-volt vehicle power is not available to the test adapter.

3.5 Connecting the AC/DC Power Supply

The AC/DC power supply (included) provides power from a wall socket. For related information, see the following sections:

- “DC Power Input” on page 10
- “AC/DC Power Supply” on page 12



To connect an AC/DC power supply:

1. Plug the 2.5 mm end of the AC/DC power supply cord into the DC port on the tool (Figure 3-7).

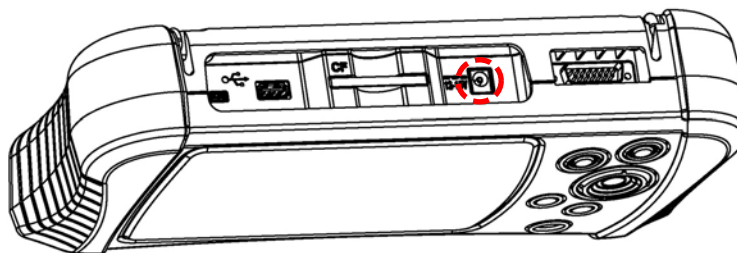

Figure 3-7 DC power supply input

2. Plug the other end of the power adapter into an appropriate wall socket.

3.6 Powering On the Unit

When a charged battery pack is installed, you can power on your scan tool.

For related information, see “Powering Off the Unit” on page 20.



To power on the scan tool:

- Press the **Power** button (Figure 2-2 on page 5).
The unit beeps and the main menu screen (Figure 3-8) displays after a few seconds.

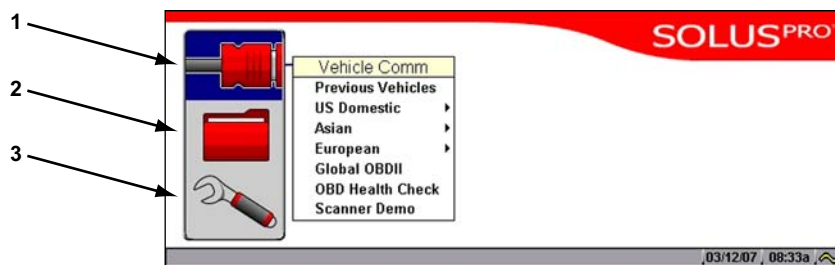

- 1— Scanner—use to access vehicle tests
- 2— Saved Data—use to access files stored in memory
- 3— Utilities—use to access tool setup and operation functions

Figure 3-8 Sample main menu

3.7 Setting Up to Print

This scan tool prints when connected to a compatible printers with a USB cable. Before you can use the Print button in the upper toolbar, you must do the following:

1. Set up the printer.
2. Connect a USB cable between the scan tool and the printer.
3. Configure the scan tool to print.

**To set up the printer:**

- Refer to your printer's documentation for powering and paper loading instructions.

**To configure the scan tool to print:**

- Select a printer manufacturer and port from the **Utilities > Tool Setup > Printer** dialog box. See "Printer" on page 57 for details.

3.8 Connecting to a Computer

Connecting your scan tool to a computer for file sharing requires the use of the optional ShopStream Connect™ software. ShopStream Connect is a free software program that can be downloaded from the Internet at software.snapon.com.

3.9 Powering Off the Unit

Use the **Power** button (Figure 2-2 on page 5) to turn the scan tool off.

IMPORTANT:

Do not attempt to turn off the scan tool with the power button while it is operating in Scanner mode. Exit Scanner mode before powering down.

**To power off the unit:**

1. Make sure you have exited the vehicle communication software as described in "Terminating Vehicle Communication" on page 34.
2. Exit Scanner mode as described in "Exiting Scanner Mode" on page 34.
3. Press the **Power** button.

The Turn off dialog box displays (Figure 3-9).

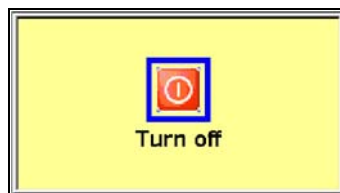

Figure 3-9 Turn off dialog box

4. Press **Y/✓** to turn the power off, or press **N/X** to cancel.

3.10 Adjusting Brightness and Contrast

The **Brightness/Contrast** button lets you to adjust the screen for optimum viewing.

**To adjust screen brightness and contrast:**

1. Press the **Brightness/Contrast** button.
The Set Brightness/Contrast dialog box displays (Figure 3-10).
2. Select a slider control using the right ► or left ◀ arrow.
3. Press the up ▲ or down ▼ arrow to increase or decrease Brightness and Contrast.
4. Press **N/X** to close the Set Brightness/Contrast dialog box when you are finished.

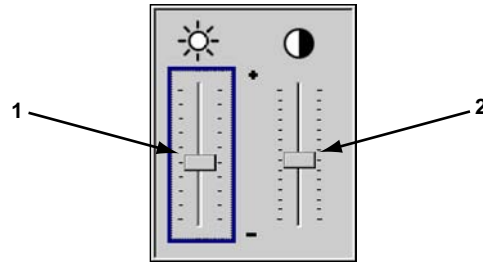

1— Brightness slider control

2— Contrast slider control

Figure 3-10 *Set Brightness/Contrast dialog box*

4.1 Screen Layout

Scan tool screens (Figure 4-1) typically include the following sections:

- The **upper toolbar** contains test controls.
- The **main body** displays menus and test data.

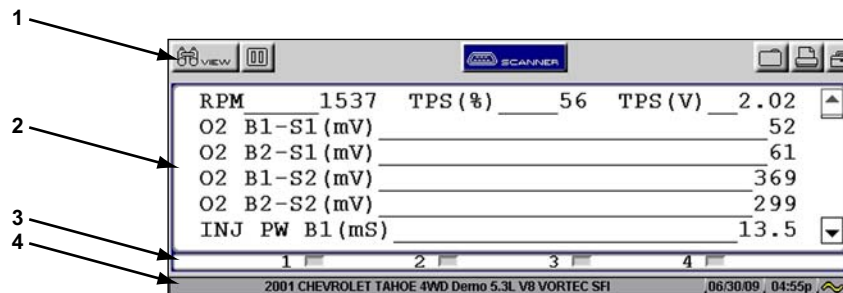

- 1— Upper toolbar
- 2— Main body
- 3— LED Indicators
- 4— Status bar

Figure 4-1 Sample screen layout

4.1.1 Upper Toolbar

The upper toolbar (Figure 4-2 and Figure 4-3) controls vary depending on the mode and stage of operations. Toolbar buttons and their function are shown in Table 4-1.



Figure 4-2 Sample upper toolbar—Text view



Figure 4-3 Sample upper toolbar—Graph view

Table 4-1 Upper toolbar controls (sheet 1 of 2)













Name	Button	Description
View		Lets you change the way data displays
Pause		Stops data collection and lets you review the buffered data

Table 4-1 Upper toolbar controls (sheet 2 of 2)

Name	Button	Description
Play		Continuously captures data and stores it in the Data Buffer
Clear		Erases all data from the Data Buffer
Sort		Lets you select the order in which the data displays
Scanner		Indicates when the Scanner screen is active
Cursor		Lets you make digital amplitude measurements of graph data
Zoom		Lets you change the magnification of the data in Graph View, or pick the number of PIDs displayed on-screen in PID List view
Snapshot		Lets you capture a snapshot using the PID Trigger or Manual Snapshot
Save		Lets you store scanned vehicle data or save the current screen in memory
Print		Lets you print the displayed screen or a list of the current parameter values
Tools		Offers a shortcuts to Custom Setup, Save Data, Custom Data List, and LED Setup. Custom Setup opens the Scanner Units dialog box, which lets you select how certain data values display. Save Data opens the Save Data dialog box that lets you configure how data is saved. Custom Data List lets you select which parameters are displayed. LED Setup lets you select which parameters are displayed on the LEDs.

Scanner Button

When the Scanner button is selected, the background of the main body turns white, indicating that the Text view is active (Figure 4-4) and the up ▲ and down ▼ arrows and the **Y/✓** and **N/X** buttons are used for screen navigation.

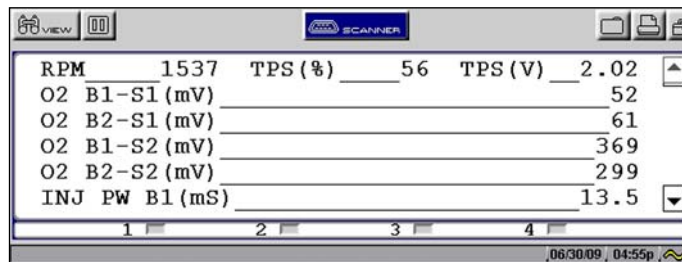

Figure 4-4 Active Scanner screen

When you select a different button from the upper toolbar using the left ◀ and right ▶ arrows in Text view, the background of the main body turns gray, indicating the screen is inactive (Figure 4-5). See “Terminating Vehicle Communication” on page 34 for more information.

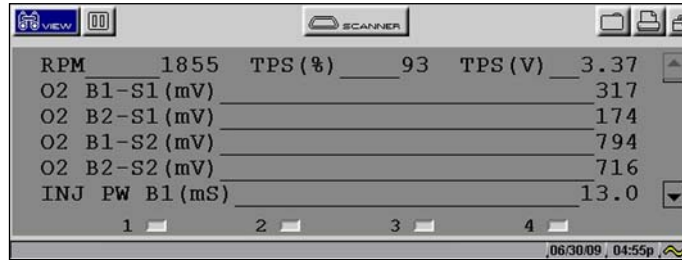

Figure 4-5 Inactive Scanner screen

4.1.2 Buffer Bar

The buffer bar displays in Graph View and PID List View and indicates the amount of data the scan tool is holding in temporary storage.

As data collects, the buffer bar fills from left to right across the screen. A full buffer is indicated by a flashing vertical line at the right end of the buffer bar (Figure 4-6). Data continues to collect once the buffer is full, older data is deleted one frame at a time as new data is added.



Figure 4-6 Sample full data buffer

You can adjust the percentage of data that is saved before and after the trigger through the Utilities Menu. See “Save Data” on page 57 for details.

4.1.3 Main Body

The main body (Figure 4-7) of the screen provides prompts. The prompts guide you through vehicle identification and task selection. Once communication is established with an electronic control module (ECM), parameter information can be displayed.

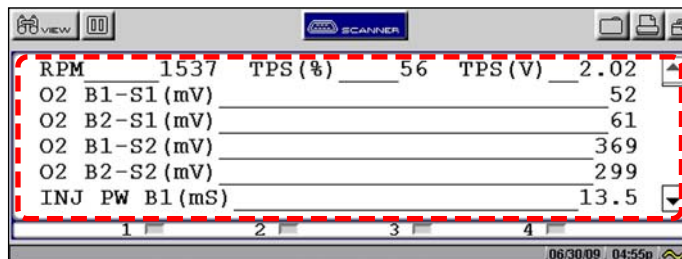

Figure 4-7 Sample Scanner main body

4.1.4 LED Indicators

Four LED indicators appear at the bottom of the screen and show designated operating conditions. The LEDs can be programmed to show change of state for certain digital parameters, which vary by manufacturer.

4.1.5 Status Bar

The status bar (Figure 4-8) at the bottom of the screen shows the test vehicle identification, the time, the date, and a power source indicator.



Figure 4-8 Sample status bar

You can adjust how the date and time display by selecting **Utilities > Tool Setup** from the tool main menu. See “Tool Setup” on page 56 for details. Power source indicator definitions are shown in Table 4-2.

Table 4-2 Power supply indicators

Indicator	Description
	Power supplied by the internal battery
	Power supplied by the vehicle
	Power supplied by the AC/DC Power Supply



NOTE:

Vehicle power is needed to ensure scan tool communication with the vehicle. Make sure the vehicle power icon displays on the status bar before attempting to perform tests.

4.2 Making Selections

Use the following instructions to navigate the interface and make selections.



To navigate the upper toolbar:

- Press the left ◀ and right ▶ arrows of the Thumb Pad.



To navigate the main body:

- Press the up ▲ and down ▼ arrows of the Thumb Pad.



To make selections:

1. Highlight a button or menu option.
2. Press **Y/✓** to confirm the selection.

4.3 Using Easy Scroll

Instead of using the Thumb Pad to highlight an item and the **Y/✓** button to select it, Easy Scroll lets you use only the Thumb Pad arrows to highlight and select items.

Easy Scroll works in the following ways:

- The up ▲ and down ▼ arrows navigate menus.
- The right ► arrow works like the **Y/✓** button to confirm the selection of menu items.
- The left ◀ arrow works like the **N/X** button for cancelling, exiting, and closing menus.

See “Easy Scroll” on page 61 for information on activating Easy Scroll.

4.4 Screen Messages

There are three types of on-screen messages:

- Confirmations
- Warnings
- Errors



To manage on-screen messages:

- Press **Y/✓** or **N/X** as indicated in the message.

4.5 Confirmation Messages

Confirmation messages inform you when you are about to perform an action that cannot be reversed or when an action has been initiated and your confirmation is needed to continue.

When a response is not required, the message displays briefly then automatically disappears.

4.6 Warning Messages

Warning messages inform you when completing the selected action may result in an irreversible change or loss of data.

4.7 Error Messages

Error messages inform you when a system or procedural error has occurred.

Examples of possible errors include:

- A cable is disconnected.
- A peripheral, such as a printer is powered off.
- A CompactFlash® card is inserted improperly.

This section explains general scan tool operations and offers instructions for customizing certain tool functions.

The following is an outline of basic operations.



NOTE:

The sequence of steps may vary depending on manufacturer or model of the test vehicle. See the Vehicle Communication Software manuals for the test vehicle for detailed procedures.

1. **Select the manufacturer**—Select and load the software database for the manufacturer of the test vehicle. See “Selecting the Manufacturer” on page 28.
2. **Identify the vehicle**—Identify the test vehicle to the scan tool by entering VIN characters and answering questions. See “Identifying the Vehicle” on page 28.
3. **Select the system**—Enter the system to be tested (engine, transmission, ABS, etc.). See “Selecting a System” on page 29.
4. **Connect the scan tool to the vehicle**—Follow the on-screen connection instructions to connect the scan tool to the vehicle. See “Connecting to a Vehicle” on page 29.
5. **Select the required test from the Scanner main menu**—Select tests for the vehicle you have identified. See “Selecting from the System Main Menu” on page 30.

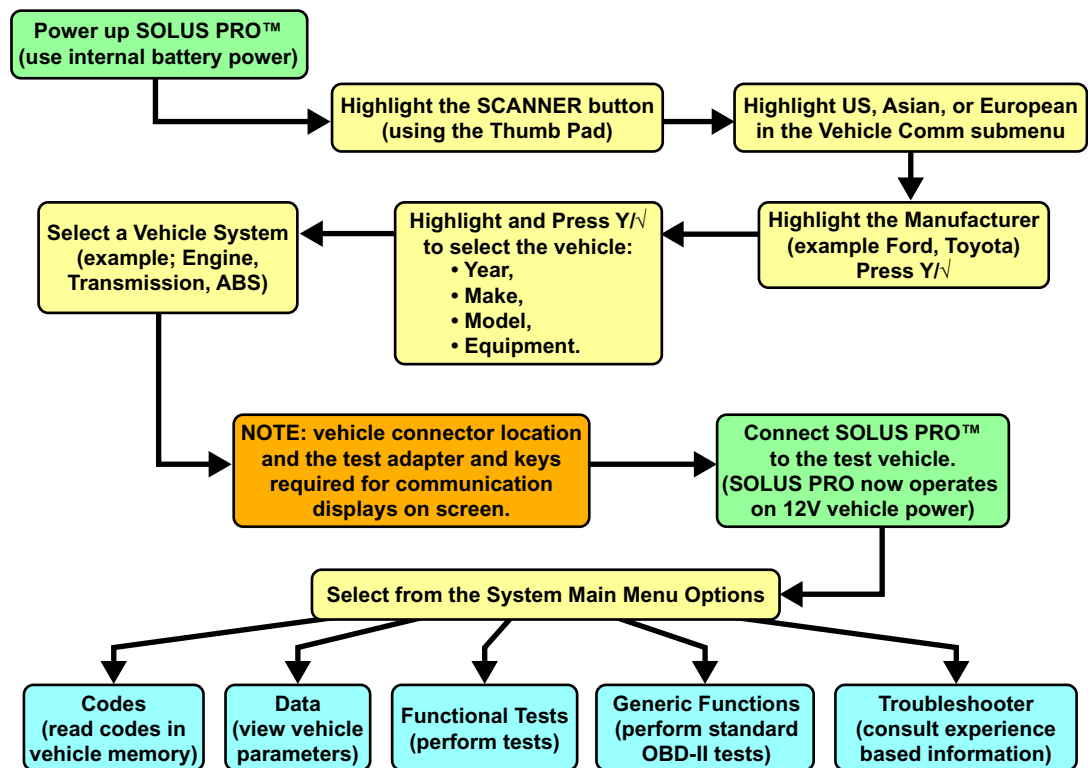

Figure 5-1 Basic scan tool operations

5.1 Selecting the Manufacturer



Vehicle manufacturers are organized into categories (Figure 5-2):

- Previous Vehicles—for recently tested vehicles
- Global OBDII—for any OBD-II/EOBD vehicle
- OBD Health Check—for any OBD-II/EOBD vehicle
- An alphabetical list of manufacturers

Each category represents a software database that includes information for a group of manufacturers.

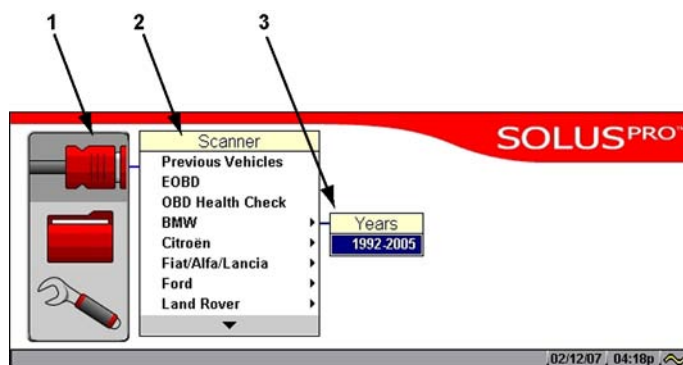

- 1— Scanner function
 2— Vehicle Communication menu
 3— Submenu

Figure 5-2 Scanner main menu software selection



NOTE:

A Years submenu displays for some selections.



To select the manufacturer:

1. From the main menu, select **Scanner**.
The Vehicle Communication menu displays (Figure 5-2):
2. Select from the submenus as necessary.
The database loads, then the first of a series of vehicle identification (ID) screens display (Figure 5-2).

5.2 Identifying the Vehicle

After you select the manufacturer, you are ready to identify the specific vehicle to be tested.



NOTE:

The exact procedure varies depending on the manufacturer. Screen prompts will guide you through the procedure.

**To identify a vehicle:**

1. Once the database loads, the first vehicle identification (ID) screen displays (Figure 5-3).
2. Press the up ▲ and down ▼ arrows on the Thumb Pad until the correct character is shown, then press **Y/✓**.

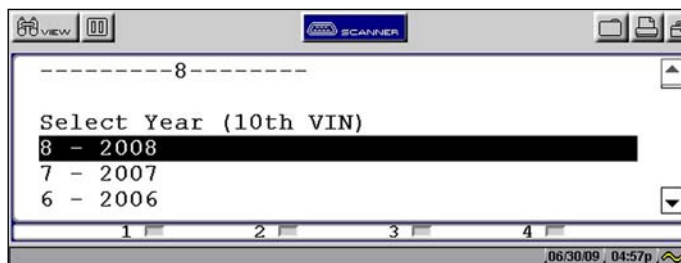

Figure 5-3 Sample Vehicle ID screen

3. Continue by entering VIN characters and pressing **Y/✓** or **N/X** to answer the on-screen questions as necessary.

Once the vehicle identification is complete, a Select System menu displays (Figure 5-4).

5.3 Selecting a System

You must select the vehicle control system you wish to test (Figure 5-4).

**To select a system:**

1. Press the up ▲ and down ▼ arrows so the cursor is at the system you wish to test.
2. Press **Y/✓** to select.

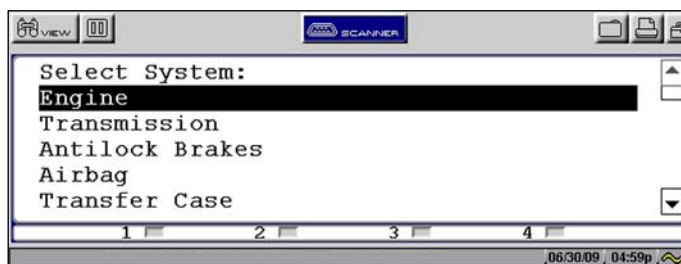

Figure 5-4 Sample system selection screen

5.4 Connecting to a Vehicle

Connection instructions prompt you to connect the scan tool to a vehicle diagnostic connector for testing (Figure 5-5).

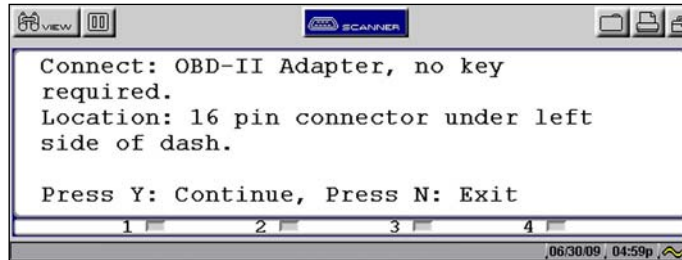

Figure 5-5 Sample connection instruction screen

Follow the on-screen connection instructions, then press **Y/✓** to open the system Main Menu.

5.5 Selecting from the System Main Menu

Depending on the vehicle, a number of options may be available on the system Main Menu (Figure 5-6). Scanner options are explained in “Using the Scanner Functions” below.

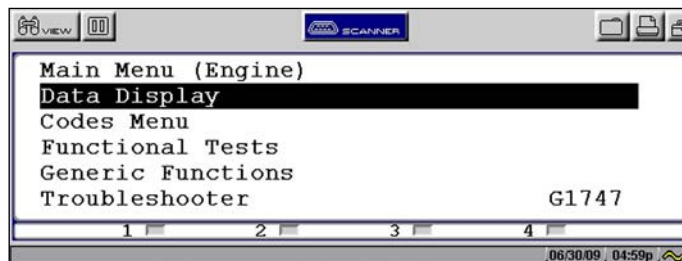

Figure 5-6 Sample system Main Menu

5.6 Using the Scanner Functions

System main menu options vary by make and model and may include the following:

- **Data Display**— displays data parameter information from the vehicle control module. selecting may open a submenu of viewing options.
- **Codes Menu**—displays diagnostic trouble code (DTC) records from the vehicle control module. selecting may open a submenu of viewing options.
- **Service Codes**—performs self-tests and displays codes after performing these tests.
- **Functional Tests**—provides specific subsystem and component tests. The tests vary depending on the manufacturer and model.
- **Actuator Tests**—similar to functional tests, these tests check the operation of certain actuators, such as solenoid valves and relays.
- **System Tests**—provides specific subsystem testing.
- **Generic Functions**—lets you access Generic OBD-II/EOBD functions.

5.6.1 Data Display

Selecting **Data Display** on the system Main Menu has one of the following results:

- A submenu of data viewing choices displays.
- Vehicle data displays.

A submenu displays when more than one data viewing mode is available on the identified vehicle (Figure 5-7).

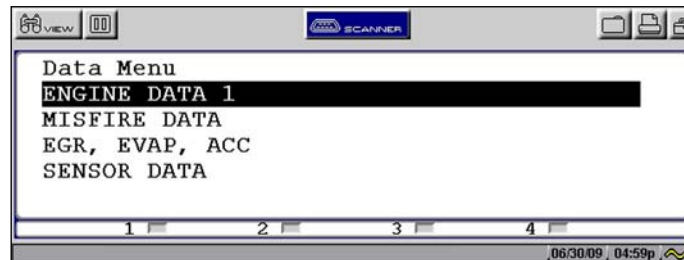

Figure 5-7 Sample data submenu

On some models, the engine must be started or cranked before data can be displayed. For these models, a "Waiting to Communicate" message displays if the engine was not cranked or started.

Data Screens

When a Data selection is made, the screen displays the data list for the selected module. The items available for any control module vary from one vehicle to another.

The top line of the display remains fixed. In some cases, the second line shows the test mode name and also indicates whether or not the vehicle can be driven during testing.

5.6.2 Codes Menu

Selecting **Codes Menu** from the system main menu opens a list of data parameter viewing options. Codes Menu selections typically include:

- Trouble Codes
- Clear Codes
- Freeze Frame/Failure Records
- DTC Status

Trouble Codes

Trouble Codes displays a list of diagnostic trouble codes (DTCs) stored in the selected electronic control module (ECM). Selecting opens a submenu of DTC viewing options on some models. Submenu options allow you to view more detailed DTC information (Figure 5-8).

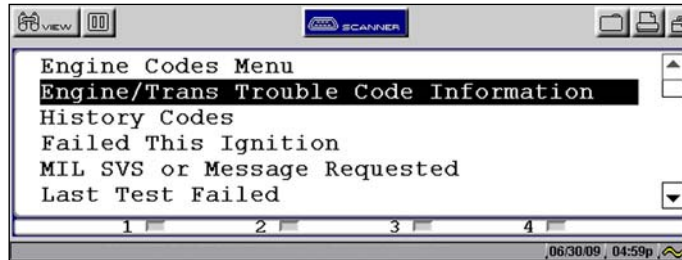

Figure 5-8 Sample Trouble Codes submenu

Clear Codes

The scan tool clears trouble codes from the control module memory on some vehicles. If this function is not available on the test vehicle, Clear Codes does not appear as a menu option.

Freeze Frame/Failure Records

This selection displays the DTC that was set, along with corresponding data, when the ECM commanded the malfunction indicator lamp (MIL) to turn on.

DTC Status

This selection allows you to see if a particular DTC caused the MIL to turn on.



To check DTC status

1. Select **DTC Status** from the Codes Menu.

The DTC Status screen displays with the cursor at the second character of the code (Figure 5-8).

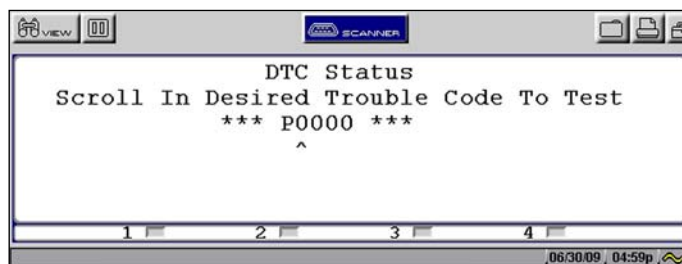

Figure 5-9 Sample DTC Status entry screen

2. Use the up ▲ and down ▼ arrows to enter the second character.
3. Press **Y/✓** and the cursor moves to the third character.
4. Use the up ▲ and down ▼ arrows to enter the third character.
5. Press **Y/✓** and the cursor moves to the fourth character.
6. Use the up ▲ and down ▼ arrows to enter the fourth character.
7. Press **Y/✓** and the cursor moves to the fifth character.
8. Use the up ▲ and down ▼ arrows to enter the fifth character.

9. Press **Y/✓** and the status of the selected DTC displays (Figure 5-10).

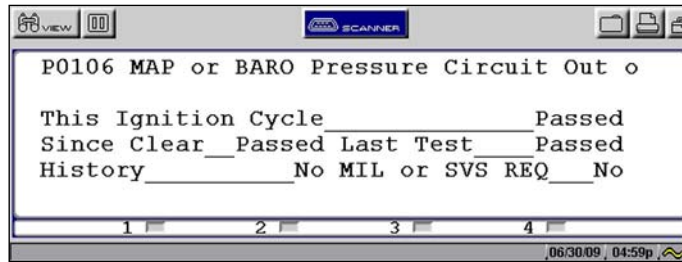

Figure 5-10 Sample DTC Status screen

10. Press **N/X** to return to the DTC status entry screen.
11. Press **N/X** again to return to the Codes menu.

5.6.3 Functional Tests

The **Functional Tests** selection is used to access vehicle-specific subsystem and component tests. Available tests vary by manufacturer, year, and model, and only the available tests display in the menu.

There are four general types of functional test operations:

- **Information Tests**—are read-only tests, like selecting “VIN” from a Functional Tests menu to display the VIN of the identified vehicle.
- **Toggle Tests**—switch a component, such as a solenoid, relay, or switch, between two operating states. The terms “on/off,” “open/clsd” (open/closed), “enab/disa” (enable/disable), and others may be used to identify the different states.
- **Variable Control Tests**—command a certain value for a system or component, such as varying the spark timing in 1° increments or the EGR valve duty cycle in 10% increments.
- **Reset Tests**—reset the adaptive, or learned, values that are stored in the control module.

5.6.4 Generic Functions

The **Generic Functions** selection opens a menu of available OBD-II/EOBD functions on 1996 and newer vehicles. Menu options typically include:

- Freeze Frame—displays data stored in ECM memory when a DTC is set
- Readiness Monitors—displays the status of the OBD-II/EOBD required monitors
- Mode 6 Non Cont—displays the status of non-continuous OBD-II/EOBD monitors
- Mode 9 Calib. ID—displays the calibration identification numbers of the vehicle ECMs
- Mode 9 (CVN)—displays the calibration verification numbers of the vehicle ECM
- Mode 9 (VIN)—displays the vehicle identification number

5.6.5 Terminating Vehicle Communication

You must terminate communication with the vehicle control module in order to safely shut down the scan tool. Use the following procedure to terminate correctly.



To terminate communication:

- Press **N/X** until you reach the main menu (Figure 5-11).

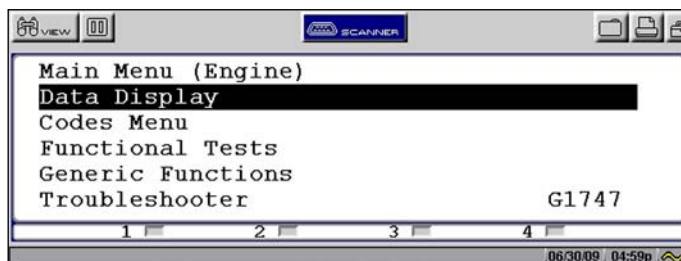

Figure 5-11 Sample main menu

A “stopping communication” message appears briefly before the main menu displays.

5.6.6 Exiting Scanner Mode

Always exit Scanner mode before powering off. Exiting Scanner mode is different depending on the view option selected.

IMPORTANT:

Exiting Scanner mode does not ensure that you have safely terminated communication with a vehicle. See “Terminating Vehicle Communication” on page 34.



To exit Scanner mode from text screens:

1. Use right ► and left ◀ arrows to scroll the highlight off of the **Scanner** button.
2. Press **N/X** to return to the main menu.



To exit Scanner mode from PID List or Graphs views:

- Press **N/X** until you return to the main menu.

5.7 Viewing Data Graphically

The scan tool provides multiple options for viewing and sorting collected data.

5.7.1 Changing Screen Views

Data can be viewed in the following formats:

- PID List view

- Text view
- Graph view



To change screen views:

1. Select the **View** button to open the drop-down menu (Figure 5-12).

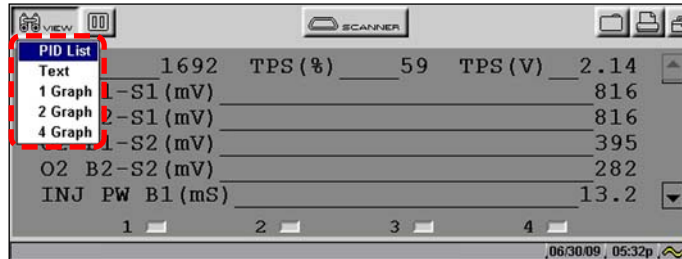

Figure 5-12 Sample View menu

2. Select an option from the menu and the screen layout changes to the selected format.

5.7.2 PID List View

The parameter identification (PID) List view displays all parameters in a table format. As many as eight parameters (Figure 5-13) can be viewed on one screen depending on the Zoom setting.

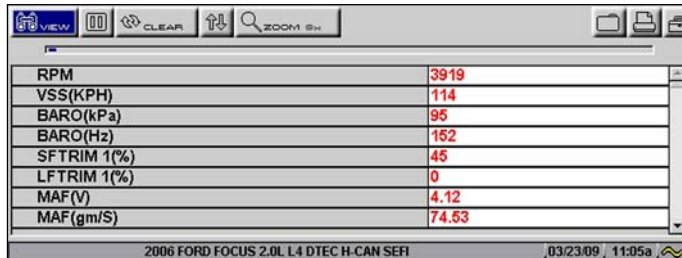

Figure 5-13 Sample PID List view



To adjust the Zoom setting

1. Select the **Zoom** button on the upper toolbar to open the dropdown menu (Figure 5-14).

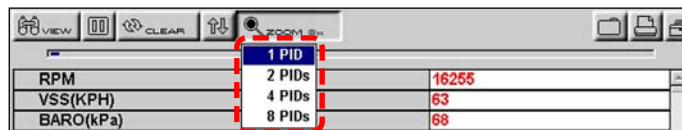
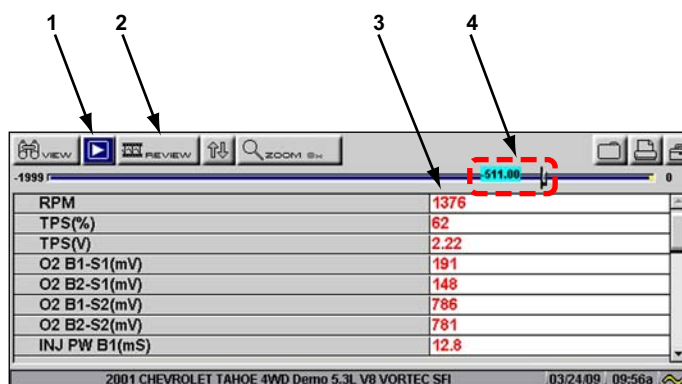

Figure 5-14 Sample Zoom dropdown menu

2. Highlight a menu option and press **Y/✓**.
The menu closes and the display changes to show the selected number of PIDs.

Reviewing PIDs

You can review up to 2000 frames of collected PID data by pausing the screen (Figure 5-15).



- 1— Pause/Play button
- 2— Review
- 3— PID data
- 4— Buffer bar indicator

Figure 5-15 Sample paused upper toolbar in PID View



To review collected PID data:

1. Select the **Pause** button to stop the data collection.
2. Select the **Review** button and use the right ► and left ◀ arrows to scroll through the data stored in the buffer. The status bar indicator shows your position in the stored data.
3. Press **N/X** to release the **Data Review** control.
4. Select the **Play** button to cancel the pause and resume live data collection.

Clearing the Buffer

The Clear button on the toolbar erases all of the data in the buffer.



To clear the data buffer:

1. Select **Clear** on the upper toolbar.
A confirmation screen displays.
2. Press **Y/✓** to erase the data, **N/X** to cancel.

New data begins saving after the buffer has been cleared.

Sorting the PID List

The Sort button on the toolbar allows you to arrange the parameter list three ways:

- Factory Sort—in the order transmitted by the electronic control module (ECM)
- A-Z Sort—in alphabetical ascending order
- Z-A Sort—in alphabetical descending order



To sort the PID List:

1. Select the **Sort** button on the upper toolbar.
2. Highlight an option on the dropdown menu (Figure 5-16).



Figure 5-16 Sample sort dropdown menu

3. Press **Y/✓** to sort.



NOTE:

Any PIDs that were locked are unlocked whenever a selection is made from the Sort button.

Locking PIDs

You can lock PIDs in place for customized list viewing.



To lock a PID:

1. From the upper toolbar, press the down ▼ arrow.
2. Select the PID you want to lock.
The parameter menu displays (Figure 5-17).

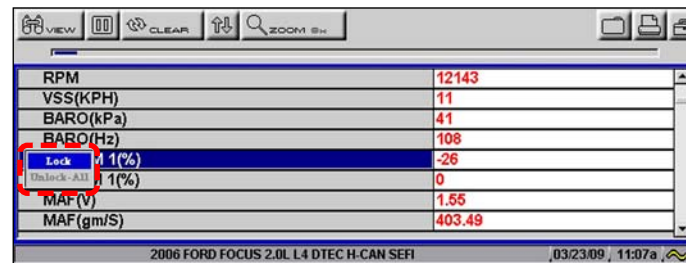

Figure 5-17 Sample parameter menu

3. Select **Lock**.

A lock icon displays to the left of the parameter name (Figure 5-18) and the locked PID stays in place when your scroll through the PID list.

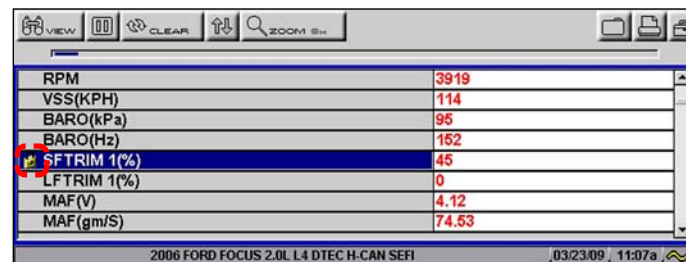

Figure 5-18 Locked PID sample

4. Repeat the above steps to lock multiple PIDs.

5. Press **N/X** to return to the upper toolbar.



To unlock PIDs:

1. Select a locked PID and when the parameter menu displays, select **Unlock**.
The lock icon disappears and the parameter can be scrolled as before.
2. Press **N/X** to return to the upper toolbar.



NOTE:

Select **Unlock All** to release all of the locked parameters at once.

5.7.3 Text View

Text view displays parameters as plain text (Figure 5-19).

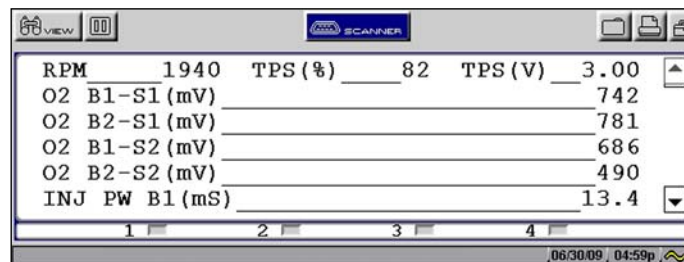
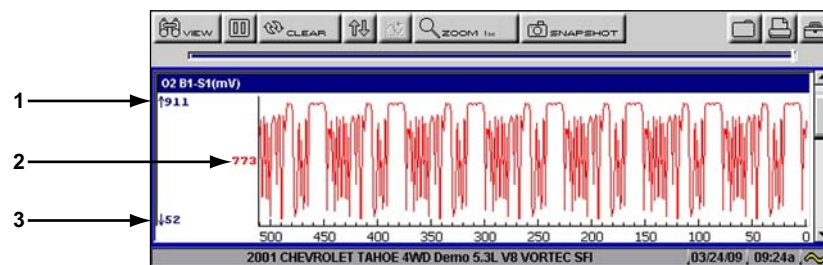

Figure 5-19 Sample Text view

5.7.4 Graph View

The Graph view let you view data in line graph format (Figure 5-20).



- 1— Maximum value of captured data
- 2— Current value
- 3— Minimum value of captured data

Figure 5-20 Sample 1 Graph screen

Parameter Menu

When viewing data in the Graph view, the scan tool offers a parameter menu (Figure 5-21) with the following options:

- **Lock**—lets you lock a parameter into position to compare readings.
- **Unlock**—lets you unlock a single parameter.
- **Unlock All**—lets you unlock all locked parameters.
- **Scale**—lets you rescale the minimum and maximum graph values captured within the last 2000 points.
- **Scale All**—lets you rescale all the minimum and maximum graph values.
- **Set Trigger Levels**—lets you specify automatic screen-freezing conditions when **Snapshot > PID Trigger** is used.
- **Clear Trigger Levels**—lets you remove set trigger conditions from the selected parameter.
- **Clear All Trigger Levels**—lets you remove set trigger conditions from all parameters simultaneously.

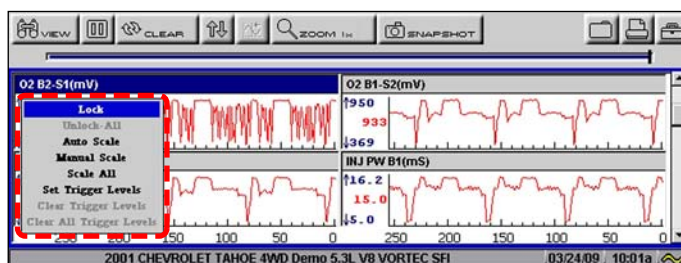

Figure 5-21 Sample parameter menu



To lock a parameter:

1. From the upper toolbar, press the down ▼ arrow to highlight the first parameter graph.
2. Select the parameter you want to lock.
The parameter menu displays.
3. Select **Lock**.

A lock icon displays (Figure 5-20). The locked graph will not move when you scroll through the remaining graphs.

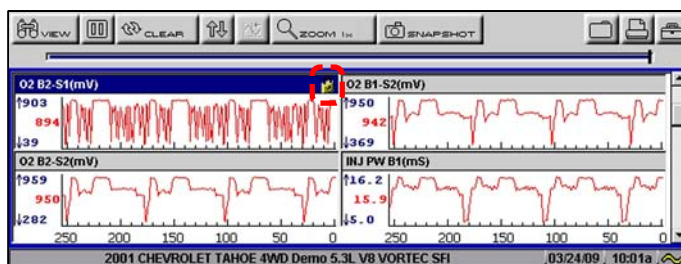

Figure 5-22 Lock icon indicating a locked parameter

4. Scroll other parameters into place to compare readings.



To unlock a parameter:

1. Select the locked parameter.
The parameter menu displays.
2. Select **Unlock**.
The lock icon disappears and the parameter can be scrolled as before.



To unlock all parameters:

1. When a PID is locked on-screen, select any parameter.
The parameter menu displays.
2. Select **Unlock All**.
All of the lock icons disappear and all of the locked parameters can now be scrolled.



To scale a parameter:

1. Select a parameter.
The parameter menu displays.
2. Select **Auto Scale**.
The minimum and maximum graph values are reset for the selected parameter.



To manually scale a parameter:

1. Select a parameter.
The parameter menu displays.
2. Select **Manual Scale**.
A line displays across the top of the graph along with a box that displays the maximum recorded value (Figure 5-23).

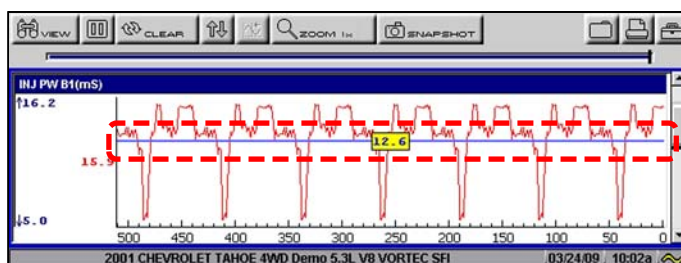

Figure 5-23 Sample manually scaling a parameter

3. Use the down ▼ arrow to move the maximum displayed value into position.
4. Press **Y/✓** to set the selected value.
5. Press **Y/✓** to scale the minimum value.
6. Use the up ▲ arrow to move the maximum displayed value into position.
7. Press **Y/✓** to set the selected value.
8. Press **N/X** to exit manual scale.
The top and bottom of the graph is now clipped so that only the portion that falls between the selected minimum and maximum values displays.



To scale all parameters:

1. Select a parameter.
The parameter menu displays.
2. Select **Scale All**.
The minimum and maximum graph values are reset for all of the parameters.



To set trigger levels:

1. Select a parameter.
The parameter menu displays.
2. Select **Set Trigger Levels**.
The active trigger level line displays as a solid line together with a position value (Figure 5-24).

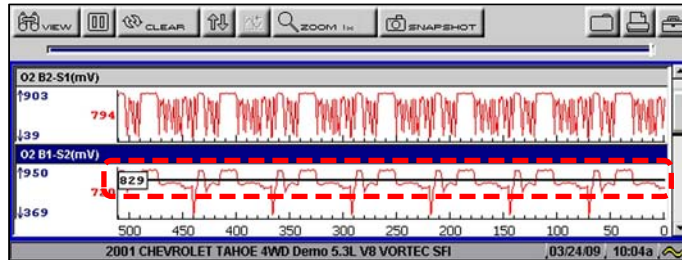

Figure 5-24 Sample active trigger line



NOTE:

Both an upper and lower trigger level must be set.

3. Adjust the upper trigger level using the up ▲ and down ▼ arrows to place the trigger level line where you want it on the PID graph.
 4. Press **Y/✓** to set the trigger.
- When set, the solid black line changes to a dotted line and the position value no longer displays (Figure 5-25).

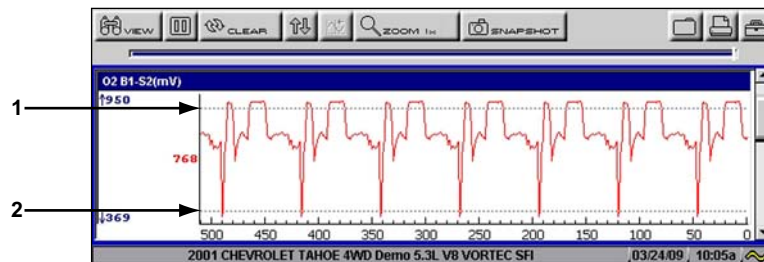

1— Upper trigger level

2— Lower trigger level

Figure 5-25 Sample set trigger levels

5. Adjust the lower trigger level using the up ▲ and down ▼ arrows and press **Y/✓** to set it.
The area between the two trigger levels establishes the triggering condition. Any data points that register outside of your set condition trigger the on-screen graphing to pause.
6. Press **Y/✓** if you want to switch between trigger level lines during the setting process.
7. When you finish setting your trigger level, press **N/X**.



NOTE:

Only three PIDs can have trigger levels set at one time, but only one of the conditions needs to be satisfied for triggering to occur.



To arm PID Triggering:

1. From the upper toolbar, select **Snapshot > PID Trigger**.
2. Select from the dropdown menu (Figure 5-26):
 - **PID Trigger**—begins collecting when a signal outside the set conditions occurs
 - **Manual**—begins collecting the next time the Snapshot button is selected



Figure 5-26 Sample armed triggering

A check mark displays next to the selected menu option.

Trigger Delay

Once the trigger is detected, a collecting snapshot window opens (Figure 5-27).



Figure 5-27 Sample collecting snapshot window

When a snapshot is taken, the scan tool retrieves some of the buffered data, captures data at the trigger point, and records additional data after the trigger point. This gives you a complete picture of what was happening before the fact, what occurred at the trigger point, and what happened after the fact.

The amount of data collected is specified by the **% After Trigger** setting, found in **Utilities > Tool Setup > Save Data**. You can manually stop the snapshot by pressing **Y/✓** at any time during the data collection.

Once data collection is finished, graphing on-screen stops and the Pause button automatically changes to the Play button. A vertical line now appears on each of the data graphs to indicate the triggering point. The trigger line on the parameter that triggered the snapshot is a different color than those on the other graphs (Figure 5-28). This makes it easy to determine which parameter caused the trigger.

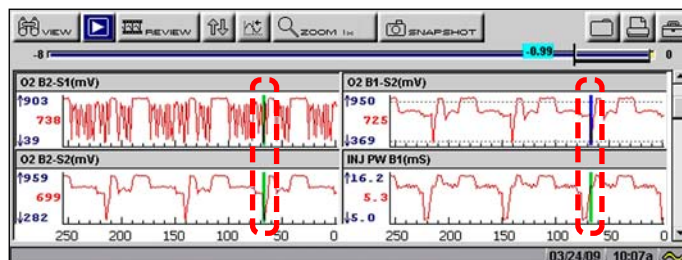

Figure 5-28 Sample trigger detection lines

- ▶ **To restart graphing:**
 - Select the **Play** button (Figure 5-28).

- ▶ **To clear trigger levels:**
 1. Select a parameter.
The parameter menu displays.
 2. Select a **Clear** option.
 - **Clear Trigger Levels**—removes the trigger settings from the one selected PID only.
 - **Clear All Trigger Levels**—removes the trigger settings from all of the PIDs.

- ▶ **To disarm PID Triggering:**
 - Select **Snapshot > PID Trigger**.
The check mark next to the menu option disappears.

5.7.5 Pausing Data

The **Pause** button temporarily stops, or “pauses”, data collection (Figure 5-29).



Figure 5-29 Pause button viewing “live-screen” data

When the **Pause** button is selected, it changes to the **Play** button (Figure 5-30), which resumes data collection.



Figure 5-30 Play button—viewing “paused-screen” data

5.7.6 Clearing the Data Buffer

The Clear button on the toolbar erases all of the data in the buffer. A confirmation screen displays when the clear button is selected. New data begins saving after the buffer has been cleared.

5.7.7 Sorting the Data

The Sort button on the toolbar allows you to arrange the parameter list three ways:

- **Factory Sort**—in the order transmitted by the electronic control module (ECM)
- **A-Z Sort**—in alphabetical ascending order
- **Z-A Sort**—in alphabetical descending order



To sort the data list:

1. Select the **Sort** button on the upper toolbar.
2. Highlight an option on the dropdown menu:
3. Press **Y/✓** to sort.



NOTE:

Any locked parameters are unlocked whenever a selection is made from the Sort button.

5.7.8 Using Cursors

When data is paused in Graph view, the **Cursor** button displays on the upper toolbar (Figure 5-31), which allows you to view digital amplitude measurements of frozen data.

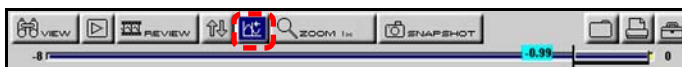

Figure 5-31 Sample paused screen with Cursors active



To use the Cursor:

1. Select the **Pause** button.
2. Select the **Cursor** button.

Cursors lines display (Figure 5-32). The value where the cursor line intersects the data displays above the cursor line.

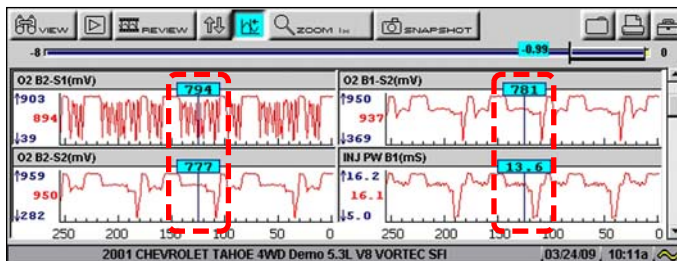

Figure 5-32 Sample cursors on paused data

3. Press the left ◀ and right ▶ arrows to move the cursor.
4. Press **N/X** to exit the Cursor mode.

5.7.9 Using Zoom

The **Zoom** button lets you choose the number of PIDs that display when used in the PID List view and lets you choose different levels of magnification when used in the Graph view (Figure 5-33).

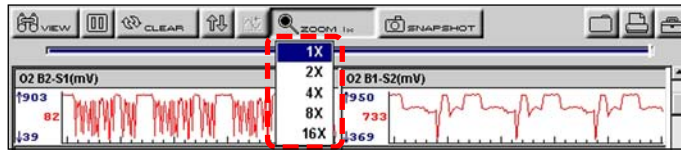

Figure 5-33 Sample Graph Zoom options

With paused data, a Zoom Out selection is available on the dropdown menu (Figure 5-34).

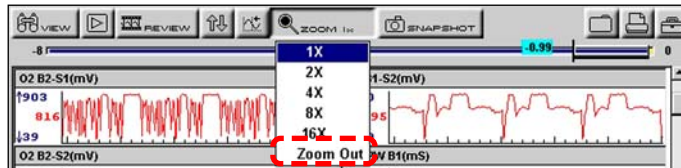

Figure 5-34 Sample Zoom options on paused data

Select **Zoom Out** and all of the data in the buffer displays on the graphs.

5.8 Saving Captured Data

The scan tool provides multiple options for saving and reviewing captured data:

- **Save Frame**—This feature allows you to save up to 512 frames of buffered data (data held in scan tool memory) for each parameter. Pages can be saved from the Text, PID, and Graph views, but can only be replayed in the Graph view.
- **Save Movie**—This feature allows you to save up to 2000 frames of data (buffered data plus data transmitted after triggering) for each available parameter. Files can be saved from the Text, PID, and Graph views, but can only be replayed in the Graph view.
- **Save Image**—This feature allows you to capture a single screen as an image. Image files can be opened with common computer programs, such as Microsoft Paint.



To save a frame:

1. Select the **Save** button from the toolbar.
A dropdown menu of choices displays (Figure 5-35).

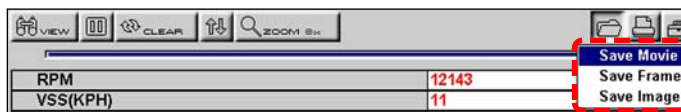

Figure 5-35 Save button menu

2. Select **Save Frame** from the menu.
The Setup Saved Data Notation dialog box displays (Figure 5-36).

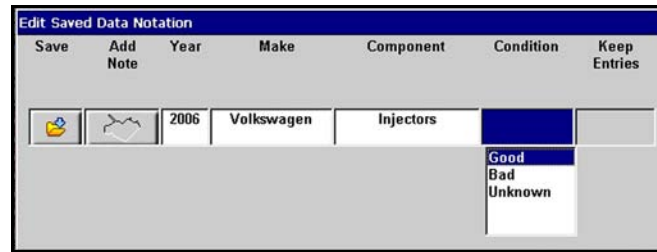

Figure 5-36 Sample saved data notation box

3. Use the dropdown lists to enter vehicle information.
4. Select **Save** to close the dialog box.
A saving data message displays. Once the message clears, the file is ready for reviewing.



To review a Save Frame file:

1. Select the **Saved Data** button from the main menu.
2. Select the **Data Management** option (Figure 5-37).

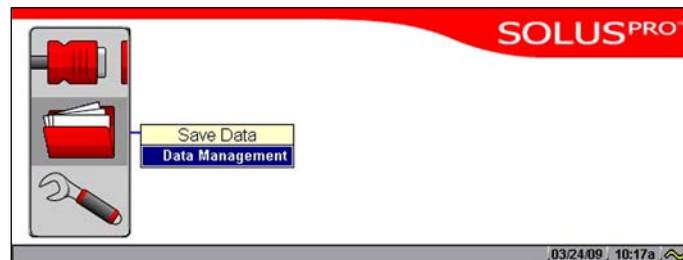

Figure 5-37 Data Management menu option

A list of all saved files displays.

3. Select the file that you would like to review (Figure 5-38).

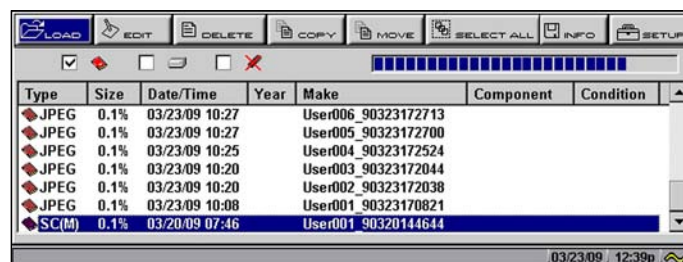

Figure 5-38 Sample saved data list



NOTE:

Frame files are saved with a SC(S) file type designation.



To save movie file:

1. Select the **Save** button from the toolbar.
A dropdown menu of choices displays (Figure 5-35).
2. Select **Save Movie** from the menu.

The Setup Saved Data Notation dialog box displays (Figure 5-36).

3. Use the dropdown lists to enter vehicle information.
4. Select **Save** to close the dialog box.

A saving data message displays. Once the message clears, the file is ready for reviewing.



To review a movie file:

1. Select the **Saved Data** button from the main menu.
2. Select the **Data Management** option (Figure 5-37).
A list of all saved files displays.
3. Select the file that you would like to review (Figure 5-38).



NOTE:

All movie files are saved with a SC(M) file type designation.

4. Select the **Review** button to set the data viewing speed.



To save an image file:

1. Select the **Save** button from the toolbar.
A dropdown menu of choices displays (Figure 5-35).
2. Select **Save Image** from the menu.



To review an image file:

1. Select the **Saved Data** button from the main menu.
2. Select the **Data Management** option (Figure 5-37).
3. A list of all saved files displays.
4. Select the file that you would like to review.



NOTE:

Image files are saved with either a BMP or JPG file type designation.

5.9 Viewing Saved Data



Use the **Saved Data** button to access the Data Management screen option.

The Data Management screen navigates scan tool storage memory and saved files (Figure 5-39).

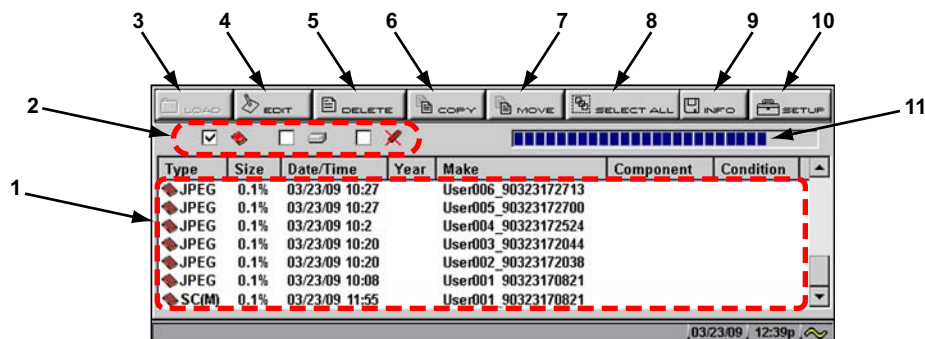

1— Saved data files

2— Saved data location indicators

Displays where the saved files are located; the CF card, internal memory, or a USB mass storage device. A red "X" indicates there is no device installed in that port.

3— Load button

Opens the saved file selected.

4— Edit button

This function is not available in the Scanner software.

5— Delete button

Erases the saved file(s) from storage memory.

6— Copy button

Lets you copy the selected file(s) from one location to another.

7— Move button

Lets you move the selected file(s) from one location to another.

8— Select All button

Selects all files.

9— Info (information) button

Displays the number of files saved and the amount of memory used and available.

10— Setup button

Lets you set the location where files are saved.

11—Memory indicator

Displays the amount of memory available.

Figure 5-39 Sample Data Management screen

5.9.1 Identifying Saved Files

Saved files have the following characteristics:

- **Type** names the kind of saved data file:
 - **SCM**—Movie data file of up to 2000 data points saved from the **Save All Pages** item on the upper toolbar.
 - **SCS**—Frame data file of up to 512 data points saved from the **Save Page** item on the upper toolbar.
 - **SCP**—Snapshot file of one datastream transmission saved from the **Snapshot** button on the upper toolbar.

- **BMP**—Screenshot saved with the **S** button set to save a bitmap image. See “Save Data” on page 57 for details.
- **JPG**—Screenshot saved with the **S** button set to save a jpeg image. See “Save Data” on page 57 for details.
- **Size** is the percentage of available storage space used.
- **Date/Time** is the date and time that the data was saved.
- **Year** is the vehicle model year.
- **Make** is the vehicle manufacturer.
- **Component** is the component tested.
- **Condition** is for good, bad, or unknown status options.



To exit the Data Management screen:

- Press **N/X**.

5.9.2 Loading Saved Files

The **LOAD** button lets you review saved screen data and print the screen.



To load data:

1. Select **Saved Data > Data Management**.
The Data Management screen displays.
2. Select a file from the list.
3. Select **Load** from the upper toolbar.
The selected file displays.



To exit the loaded screen:

1. Press **N/X** to return to the Data Management screen.
2. Press **N/X** again to return to the main menu.

5.9.3 Editing Saved Data

The Edit button opens the Setup Saved Data Notation dialog box (Figure 5-36 on page 46). Use the dropdown lists to modify the vehicle information. Press **N/X** to exit.

5.9.4 Reviewing Saved Data

The **Review** button is used with the directional arrows to review movie data files.

There are two ways to review data files:

- Manually
- Automatically



To review data files manually:

1. Select the **Review** button.
2. Use the right ► and left ◀ arrows to review data one frame at a time.



To automatically scroll data files:

1. With the **Review** button selected, press **Y/✓** again to display a dropdown menu of options (Figure 5-40).

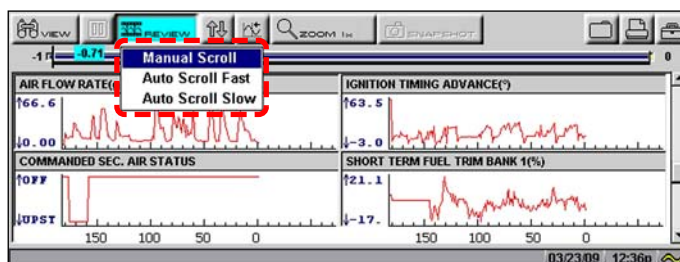

Figure 5-40 Sample Review dropdown menu

2. From the **Review** menu, select an **Auto** option.
 - Auto Scroll Fast automatically scrolls the data at full-speed.
 - Auto Scroll Slow automatically scrolls the data at half-speed.
3. Press **N/X** to close the menu.

5.9.5 Deleting Saved Files

The **Delete** button lets you remove saved files from memory.



NOTE:

Factory-installed files cannot be deleted.



To delete files:

1. Select **Saved Data > Data Management**.
2. Select a file from the list.
3. Select **Delete** from the upper toolbar.
A confirmation message displays.
4. To permanently remove the data from memory, press **Y/✓**, or press **N/X** to keep the data and close the dialog box.
After processing your delete request, you are returned to the Data Management screen.

5.9.6 Copying and Moving Saved Data

The **Copy** and **Move** functions let you transfer saved test data from one location to another.



To copy or move data:

1. From the main menu, select **Saved Data > Data Management**.
The Data Management screen displays.
2. From the upper toolbar, select **Setup**.
The Save Data dialog box displays.
3. Set **CF** as the **Save To** option and press **N/X** to close the dialog box.
The test data saved to the CF card displays.
4. Use the up ▲ and down ▼ arrows to highlight a file from the list on-screen.
5. Use right ► and left ◀ arrows to select **Copy** or **Move** from the upper toolbar.
A confirmation message displays.
6. Press **Y/✓** to close the message box.
You return to the Data Management screen.



NOTE:

Factory installed files can not be deleted, copied or moved.

5.9.7 Selecting All Files

Use **Select All** to highlight all files on-screen so you can delete, copy, or move the files as needed (Figure 5-41).



Figure 5-41 Sample Select All screen

5.9.8 Viewing Saved Data Information

Selecting the **Info** button on the toolbar opens a window that provides detailed information about the saved data files, such as the amount of storage memory used and the capacity of the memory storage media (Figure 5-42). Only details for the selected “Save to” destination display.

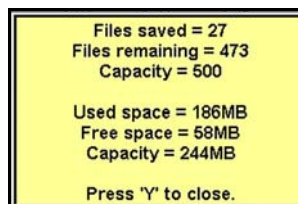

Figure 5-42 Sample Info button window

5.9.9 Setting a Destination for Saved Data

Use **Setup** to identify the destination for saved files (Figure 5-43). The default destination is the CF card slot.

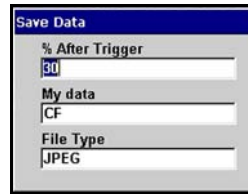

Figure 5-43 Sample Save Data dialog box



To change the destination for saved files:

1. Select **Saved Data > Data Management**.
The Data Management screen displays.
2. Select the **Setup** button.
The **Save Data** dialog box displays (Figure 5-43).
3. Select an option from the **Save to** drop-down menu.
4. Press **N/X** to confirm your selection and close the dialog box.
The checkbox for the location you selected is checked (Figure 5-44).



Figure 5-44 CF slot indicator checked

5.10 Printing

The **Print** button lets you print the displayed screen. The following printing options may be available:

- **Full Screen**—print only what is visible on the screen.
- **Full PID List**—prints the entire list of parameters.
- **Full Codes List**—prints the list of codes in vehicle memory when viewing codes.



To print:

1. Verify that your printer and scan tool are set up properly for printing. See “Setting Up to Print” on page 19 for details.
2. Select **Print >** print option (Figure 5-45).

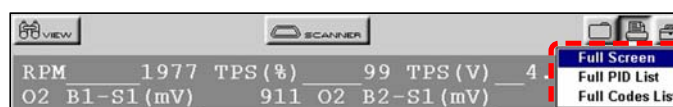

Figure 5-45 Sample Print menu

When printing begins, an “Initializing printer...” message displays. The message box closes when printing is complete.

5.11 Tools Button

The **Tools** button on the upper toolbar provides a shortcut to commonly used scan tool configuration settings (Figure 5-46).

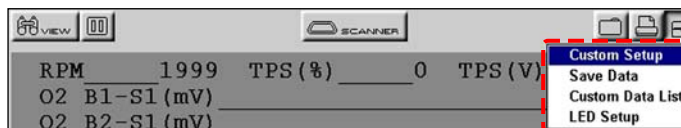

Figure 5-46 Sample Tools button menu

The following choices are available on a dropdown menu:

- Custom Setup
- Save Data
- Custom Data List
- LED Setup



NOTE:

The Custom Data List and LED Setup selections are only available when in the Text view mode, these menu selections do not display when in Graph or PID List modes.

5.11.1 Custom Setup

Selecting **Custom Setup** opens the Scanner Units dialog box. Scanner Units is used to change the units of measurement for certain parameters. You can choose between US Customary or metric units of measure for available data parameters.

All measurement units return to their default values when the internal batteries are disconnected or a different software database is selected.

Table 5-1 Units of measurement—defaults and options

SETTING	DEFAULT	OPTION
Temperature	degrees Celsius (°C)	degrees Fahrenheit (°F)
Air Pressure (including manifold pressure)	kilopascals (kPa)	inches of mercury ("Hg)
Speed	kilometers per hour (kph)	miles per hour (mph)
Other Pressures	kilopascals (kPa)	pounds per square inch (psi)



To change a setting:

1. On the upper toolbar, select **Tool > Custom Setup**.
The Scanner Units dialog box displays (Figure 5-47).

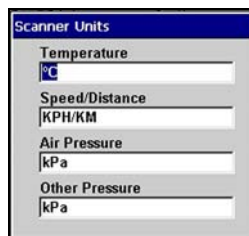

Figure 5-47 Sample Scanner Units Menu

2. Use right ► and left ◀ arrows to move between measurements, press **Y/✓** to open a dropdown menu for the item to be changed.
3. Select the desired measurement and the dropdown closes.
4. Press **N/X** to confirm your selections and return to the Tools Setup menu.

5.11.2 Save Data

Selecting **Save Data** from the dropdown menu opens the Save Data dialog box, which allows you to select where and how data is saved. Refer to "Setting a Destination for Saved Data" on page 52 for details.

5.11.3 Custom Data List

The **Custom Data List** selection, which is used to select specific data parameters to display, is only available in the Text view mode. This allows you to focus on any suspicious or symptom-specific data parameters and may allow for a faster display update rate.

Custom Data List selections are retained in the tool memory until a new vehicle ID is entered or another vehicle control system is selected for testing.

NOTE:



If a parameter is not selected for display in the Custom Data List, it will not be displayed when you enter Troubleshooter.



To select a custom data list:

1. From the Exit menu, select **Custom Data List**.

The Data Selection screen displays. An asterisk (*) next to a parameter title indicates that parameter is selected for display (Figure 5-48).

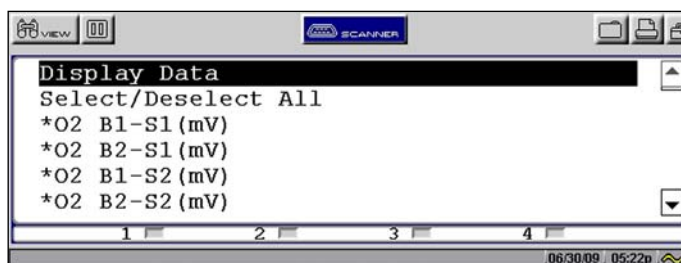

Figure 5-48 Sample Data Selection screen

2. Select or deselect the desired parameters.
3. Select **Display Data** or press **N/X** to confirm your selections and return to the data display to view the customized data list.

5.11.4 LED Setup

The LED Setup selection is used to program the operation of the four LEDs located just below the main body of the Scanner screen. The LEDs switch on and off to reflect a change of state for the assigned digital parameters. An LED turns red when switched on.



To program LED operation:

1. On the upper toolbar, select **Tools > LED Setup**.

The LED assignment menu opens with LED 1 highlighted (Figure 5-49).

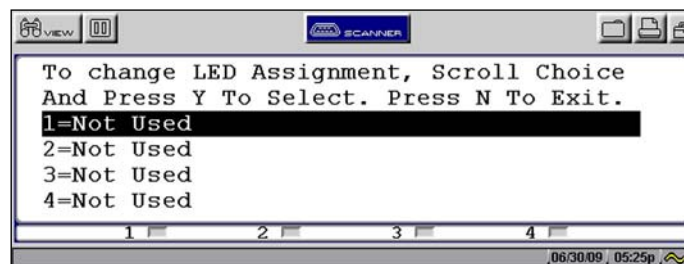

Figure 5-49 Sample LED assignment menu

2. Use the up ▲ and down ▼ arrows to scroll through the list of available parameters.
3. Press **Y/✓** to lock in a selection and move the highlight to the next LED.
4. Press **N/X** to close the menu and return to the data display once all the LEDs are assigned.

5.12 Utilities



The Utilities button provides access to system information and controls (Figure 5-50).

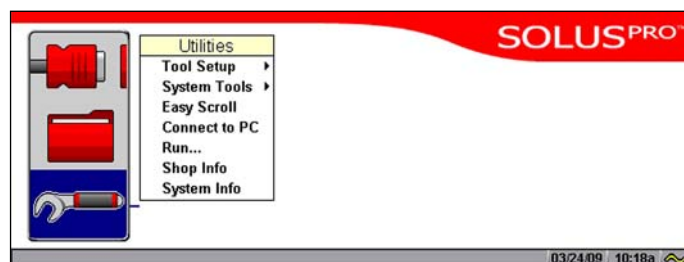

Figure 5-50 Sample Utilities menu

The Utilities options available are discussed in the following sections:

- “Tool Setup” on page 56
- “System Tools” on page 61

- “Easy Scroll” on page 61
- “Connect to PC” on page 62
- “Run” on page 62
- “Shop Info” on page 62
- “System Info” on page 63

5.12.1 Tool Setup

The Tool Setup submenu (Figure 5-51) lets you adjust certain settings for optimum performance.

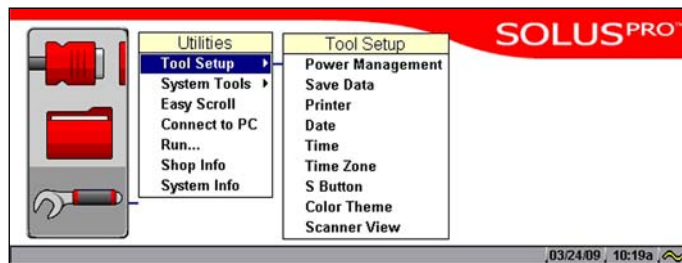

Figure 5-51 Tool Setup sample menu

The Tool Setup submenu includes the following options:

- “Power Management” on page 56
- “Save Data” on page 57
- “Printer” on page 57
- “Date” on page 58
- “Time” on page 58
- “Time Zone” on page 58
- “S Button” on page 59
- “Color Theme” on page 60
- “Scanner View” on page 60

Power Management

The Power Management option lets you select several backlight options.

- **Timer**—The backlight turns off at the set time.
- **On**—The backlight remains on at all times.
- **Off**—The backlight remains off at all times.

For related information, see “Powering Off the Unit” on page 20.



To set power management options:

1. Select **Utilities > Tool Setup > Power Management**.
The Power Management dialog box opens (Figure 5-52)

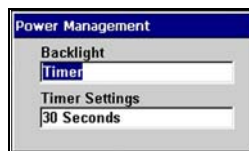

Figure 5-52 Sample Power management dialog box

2. Press **Y/✓** to open a dropdown menu for the highlighted item.
3. Use the up **▲** and down **▼** arrows to move the highlight and **Y/✓** to select settings from the drop-down menus.
4. Press **N/X** to confirm your selection and close the Power Management dialog box.

Save Data

Selecting **Save Data** lets you adjust the size of each recorded movie and the amount of data recorded after a trigger-point. **Save Data** also lets you set the saving and loading location for all saved files, and whether to save image files in bitmap or jpeg format.



To adjust save data preferences:

1. From the main menu, select **Utilities > Tool Setup > Save Data**.
The Save Data dialog box displays (Figure 5-43 on page 52).
2. Select from the dropdown lists as necessary.
The dropdown list closes automatically.
3. Press **N/X** to close the Save Data dialog box.



NOTE:

The Save Data dialog box can also be accessed from the Setup menu on the Saved Data management screen.

Printer

Select **Printer** to configure the scan tool to your printer. Your scan tool supports printing to Hewlett-Packard (HP) PCL 3 and Epson Stylus printers (color and black & white).



To configure for your printer:

1. Select **Utilities > Tool Setup > Printer**.
The Printer dialog box displays (Figure 5-53).

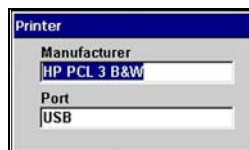

Figure 5-53 Sample Printer dialog box

2. Select from the menus as necessary.
3. Press **N/X** to close the Printer dialog box.

Date

Selecting **Date** lets you set the date that displays in the Saved Data properties.



To set the date:

1. Select **Utilities > Tool Setup > Date**.
The Date dialog box displays.
2. Press **Y/✓** to open a dropdown list of display options (Figure 5-54).

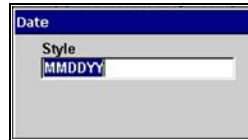

Figure 5-54 *Sample Date dialog box*

3. Select an options from the drop-down list.
The drop-down list closes automatically.
4. Press **N/X** to close the **Date** dialog box.

Time

Selecting **Time** lets you set the time that displays in the Saved Data properties.



To set the time on the system:

1. Select **Utilities > Tool Setup > Time**.
The Time dialog box displays.
2. Select the **Hour**, **Minutes**, or **12/24** field.
A drop-down list displays (Figure 5-55).



Figure 5-55 *Sample Time dialog box*

3. Select an option from the drop-down list.
The drop-down list closes automatically.
4. Press **N/X** to close the Time dialog box.

Time Zone

Selecting **Time Zone** lets you set the time zone for the internal clock, and to select between standard or daylight savings time.



To set the time zone on the system:

1. Select **Utilities > Tool Setup > Time Zone**.
The Time Zone dialog box displays (Figure 5-55).

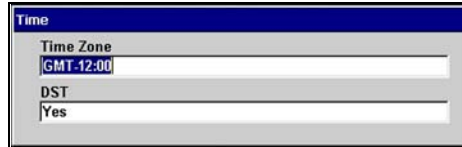

Figure 5-56 Sample Time Zone dialog box

2. Select the **Time Zone** or **DST** field to open a dropdown menu.
3. Select an option from the drop-down list.
The drop-down list closes automatically.
4. Press **N/X** to close the Time dialog box.

S Button

Selecting **S Button** allows you to change the functionality of the **S** button. Possible function assignments include:

- **Save Image**—is the default and takes a snapshot of the current screen. The snapshot is saved as either a bitmap or jpeg image, which can be opened using standard Internet browsers or graphics applications. This feature works anywhere in scan tool operations.
- **Freeze/Run**—works as the Pause/Play button when viewing data in the Graphs or PID List views. See “Pausing Data” on page 43 for details.
- **Save Frame**—works as the **Save Frame** selection from the SAVE button in the upper toolbar when this option is available. See “Saving Captured Data” on page 45 for details.
- **Print List**—works like the **Full PID List** selection from the Print button in the upper toolbar. See “Printing” on page 52 for details.
- **Print Page**—works like the **Full Screen** selections from the Print button in the upper toolbar. See “Printing” on page 52 for details.
- **S Button Popup**—opens the menu when the button is pressed so you can quickly select from any of the available functions.

NOTE:



The **S** button can only perform print functions when the **Print** button is visible in the upper toolbar.



To assign a function to the S button:

1. Select **Utilities > Tool Setup > S Button**.
The **S Button** dialog box displays
2. Press **Y/✓** to open the dropdown list (Figure 5-57).

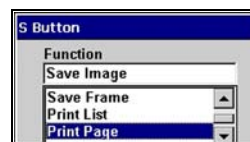

Figure 5-57 Sample S Button dialog box

3. Select a function from the drop-down list.
4. Press **N/X** to close the dialog box.

Color Theme

Selecting Color Theme lets you change the background on the display. Using the black background helps conserve battery power.



To change the screen background:

1. Select **Utilities > Tool Setup > Color Theme**.
The **Color Theme** dialog box displays.
2. Press **Y/✓** to open the drop-down list (Figure 5-58).

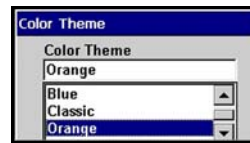

Figure 5-58 Sample Color Theme dialog box

3. Select a function from the drop-down list.
4. Press **N/X** to close the dialog box.

Scanner View

Scanner View lets you set the default setting for how the data displays. Options include:

- Text
- PID List
- Graph
- Last Used View

See “Changing Screen Views” on page 34 for additional information.



To select a Scanner View:

1. Select **Utilities > Tool Setup > Scanner View**.
The Scanner View dialog box displays.
2. Press **Y/✓** to display a dropdown list (Figure 5-59).

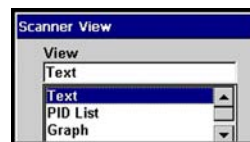

Figure 5-59 Sample Scanner View menu

3. Select an option from the drop-down list.
The drop-down list closes automatically.
4. Press **N/X** to close the Scanner View dialog box.

Navigation Prompts

Navigation prompts, available in European markets only, allows you to select how references to the **Y/✓** and **N/X** buttons display on the screen.



To change navigation prompts:

1. Select **Utilities > Tool Setup > Navigation Prompts**.
The Navigation Prompts dialog box displays.
2. Press **Y/✓** to display a drop-down list.
3. Select an option from the drop-down list.
The drop-down list closes automatically.
4. Press **N/X** to close the Navigation Prompts dialog box.

5.12.2 System Tools

The **System Tools** submenu (Figure 5-60) lets you perform system maintenance functions.

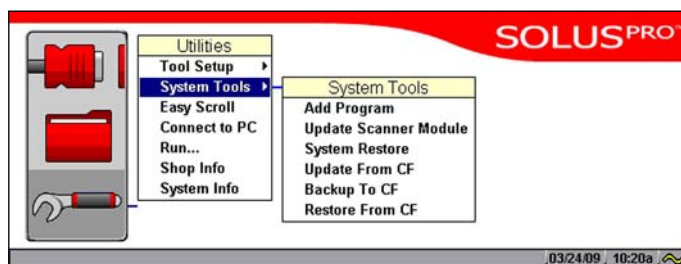

Figure 5-60 Sample System Tools submenu

System Tool options include:

- **Add Program**—lets you add optional software.
- **Update Scanner Module**—When instructed by a Help Desk representative to use, lets you update the Scanner module files.
- **System Restore**—lets you reinstall your system software.
- **Update From CF**—lets you update the system software from a CF card.
- **Backup To CF**—lets you create a backup of the system software on a CF card.
- **Restore From CF**—lets you restore the system software from a backup CF card.

5.12.3 Easy Scroll

The Easy Scroll utility functions as a selection shortcut that lets you use only the Thumb Pad arrows to highlight and select an item.

See “Using Easy Scroll” on page 26 for information on navigating with Easy Scroll.



To turn Easy Scroll on and off:

- Select **Utilities > Easy Scroll**.

A check mark along side the **Easy Scroll** option indicates that the utility is on.

**NOTE:**

Easy Scroll stays on until you manually turn it off.

5.12.4 Connect to PC

The **Connect to PC** selection is used with the optional ShopStream Connect™ software, which lets you view data files on a computer and share files.

5.12.5 Run

The **Run** option is used to access special CF card applications.

**To run special CF card applications:**

1. Insert the CF card containing the special application into CF Slot on the top of the unit (Figure 2-3 on page 5).
2. Select **Utilities > Run**.
The application begins.

5.12.6 Shop Info

The **Shop Info** option lets you add personalized shop information that can be included on printed data files.

**NOTE:**

A keyboard must be connected to the USB port on top of the scan tool in order to enter your shop information.

**To add Shop Info:**

1. Select **Utilities > Shop Info**.
The Shop Information screen displays (Figure 5-61).

The image shows a screenshot of a 'Shop Information' dialog box. It has a blue title bar and several input fields: 'Shop Name', 'Address', 'City', 'State', 'ZIP', and 'Phone'. At the bottom, there is a grey box with instructions: 'When finished entering shop information, Press Esc from the keyboard to exit. If a keyboard is not connected, Press 'N' to exit.'

Figure 5-61 Sample Shop Info dialog box

2. Connect a USB keyboard to the USB port on top of the scan tool, then use the keyboard to enter information into the text fields.
3. Disconnect the keyboard.
4. Press **Y/✓**.
5. A confirmation screen displays:
 - a. Press **Y/✓** to include shop information on printed data files.
 - b. Press **N/X** to not include the shop information on printed files.
 The Shop Information screen closes.

5.12.7 System Info

The **System Info** option lets you view configuration information for your scan tool.



To display the System information screen:

1. Select **Utilities > System Info**.

The System Information screen displays. The left field of the screen shows the information menu and the right field displays the selected information. Navigate the information screens as follows:

- a. Press the down ▼ arrow to move the highlight from the Print button to the menu.
- b. Use the down ▼ and up ▲ arrows to highlight a menu item.
- c. Press **Y/✓** to select the highlighted menu item.

The selection now displays in the right field of the screen (Figure 5-62).

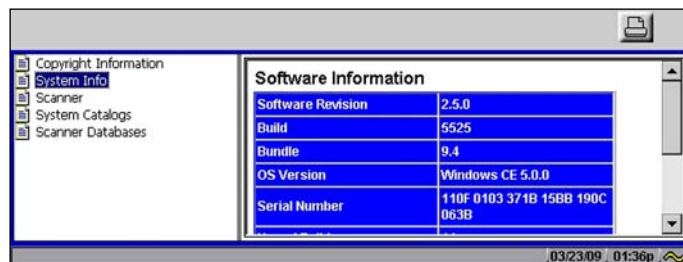

Figure 5-62 Sample System Info screen

- d. Press the right ► arrow to move from the menu field to the information field.
 - e. Use the down ▼ and up ▲ arrows to scroll the information field.
 - f. Press the left ◀ arrow to return to the menu field.
2. Press the **N/X** twice to exit System Info and return to the main menu.

This section covers the following maintenance issues:

- Cleaning and damage inspection
- Battery replacement
- Storage tips
- Disposal requirements (environmental hazards)
- “Replacing the Display Window”

6.1 Cleaning and Damage Inspection

When using the scan tool, make sure to do the following:

- Before and after each use, check the housing, wiring, and connectors for dirt and damage.
- At the end of each working day, clean the scan tool housing, wiring, and connectors with a clean damp cloth.

6.2 Battery Pack

To prolong the life of your battery pack when your scan tool is not in use, power off the unit and remove the battery pack.

6.2.1 Replacing the Battery Pack

When your battery pack no longer holds a charge, call your sales representative to order a new one. Refer to “Using the Battery Pack” on page 16 for more details.

After you replace the old battery, call Rechargeable Battery Recycling Corporation (RBRC) at 1(800) 822-8837 (USA), or refer to their web site at <http://www.rbrc.org> for the nearest recycling location and instructions for proper battery disposal.

6.3 Storage Tips

When storing your scan tool, remember the following:

- Always turn the scan tool off. See “Powering Off the Unit” on page 20 for details.
- Keep in mind the storage temperature range. See “Technical Specifications” on page 6.

6.4 Disposing of the Battery Pack

Always dispose of materials according to local regulations.

6.5 Replacing the Display Window

Use the optional Display Window Kit to replace the hard plastic faceplate of the scan tool. Thoroughly clean the scan tool first, and work carefully to keep dirt out of the unit during window replacement.



To replace the display window:

1. Place the scan tool on a flat surface facing up.
2. Hold the tool steady and depress the two lock tabs at the top of the window with your fingertips to release them (Figure 6-1).

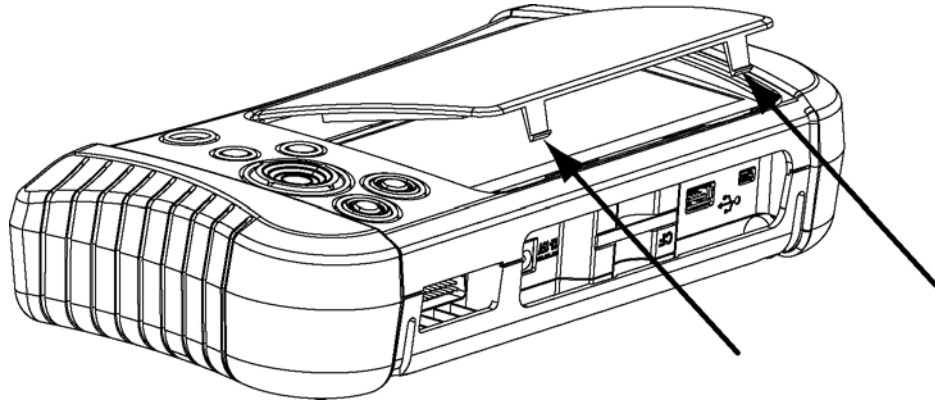

Figure 6-1 *Display window lock tabs.*

3. Tilt the top of the window up, then lift it free from the scan tool.
4. Fit the three tabs on the bottom of the new window into the slots on the scan tool.
5. Tilt the new window down to align the top lock tabs with slots on the scan tool.
6. Lightly depress the lock tabs and push down to snap the window into place.

The following frequently asked questions provide solutions to common problems.

- “Can I use my other Snap-on® test adapters with this scan tool?” on page 66
- “What should I do if my printer is not responding?” on page 66
- “What should I do if the unit doesn’t respond as expected when I press the Power button?” on page 66
- “Why does my unit shut down unexpectedly?” on page 67

A.1 Can I use my other Snap-on® test adapters with this scan tool?

Yes.

A.2 What should I do if my printer is not responding?

It may take a minute or two before the printer receives the print request.

If there is still no response after a few minutes, make sure the following conditions are met:

- The printer is receiving power and is turned on.
- The printer has paper.
- The USB cable is securely connected to the scan tool and the printer.
- The USB cable is not damaged.

For related information, see the following sections:

- “Setting Up to Print” on page 19
- “Printing” on page 52

A.3 What should I do if the unit doesn’t respond as expected when I press the Power button?

Press and hold the **Power** button to force the scan tool to shutdown. See “Forced Shutdown” on page 69 for details.

A.4 Why does my unit shut down unexpectedly?

Your internal batteries could be low. We recommend that you check all power sources.

See “Power Supply” on page 10 for more information.

This section addresses issues that may arise when using the scan tool.

B.1 No Communication Message

When the screen displays a “No Communication” or “No Response From Module” (Figure B-1) message, it means the scan tool and the vehicle control module cannot communicate with each other for some reason.

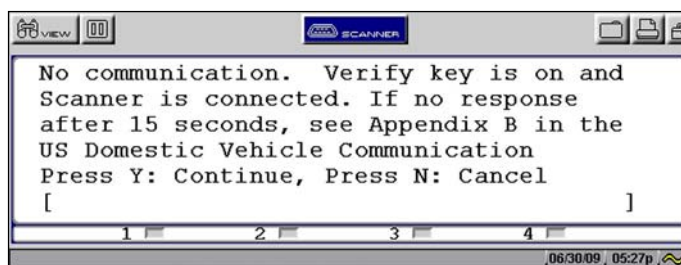

Figure B-1 Sample No Communication message



NOTE:

Your scan tool should be powered by the vehicle, check the Status Bar (Table 4-2 on page 25). If the vehicle power icon does not display, make sure the scan tool is properly connected (see “Connecting to Vehicle Power” on page 15). If vehicle power is still not available, check for circuit problems on the vehicle.

The following conditions will cause the scan tool to display a no communication message:

- The scan tool is unable to establish a communication link with the vehicle.
- You are using the incorrect Personality Key™ device with the test adapter.
- You select a system for testing that is not part of the vehicle equipment (for example—ABS on a vehicle without antilock brakes).
- There is a loose connection.
- There is a blown vehicle fuse.
- There is a wiring fault on the vehicle.
- Incorrect vehicle identification is entered.

Refer to the appropriate Vehicle Communication Software User’s Manual, included on the documentation CD, for manufacturer-specific problems.

B.2 Battery Pack Not Charging

If the battery pack does not charge, check for the following:

- The battery pack may not be installed in the battery charger unit properly.
Make sure the battery charger unit is receiving power; and, without using force, adjust the battery pack position in the battery charger unit until the red status light displays.
- The battery pack may be too hot.
Allow the battery pack to cool to at least 104°F (40°C). If left in the battery charger unit, once the proper room temperature is achieved, charging will begin.
- The battery pack may be too cold.
Allow the battery pack to warm to at least 32°F (0°C). If left in the battery charger unit, once the proper room temperature is achieved, charging will begin.
- The battery pack may be dead.
The battery pack must be replaced. See “Replacing the Battery Pack” on page 64. Use another power source to continue working. See “Power Supply” on page 10.

B.3 Unit Will Not Power On

The following conditions will prevent your scan tool from powering on:

- No or expired battery pack (see “Battery Pack” on page 11)
- The vehicle diagnostic connector that does not supply power, the auxiliary power cables are required (see “Auxiliary Power Cables” on page 13 and “Vehicle Power” on page 11)

B.4 Forced Shutdown

If your scan tool freezes or will not power off, you can perform a forced shutdown.



To perform a forced shutdown:

1. Press and hold down the **Power** button for five seconds.
2. The scan tool sounds a series of beeps, then turns off.
The unit can now be restarted.

B.5 Beep Codes

The scan tool contains a tone generator that produces a series of audible tones, or beeps, to alert the user to certain operating conditions. Use the table below to interpret beep codes:

Table B-1 *Beep code definitions*

Function	Beep Code
Power up	Short beep
Forced shutdown	Short beep–pause–three double beeps–pause–extra long beep
Normal shutdown	Short beep (button pressed)–extra long beep (at power down)
Low internal battery turn on	Six long beeps
Low internal battery shutdown	Extra long beep
Short beep = 80 ms, long beep = 100 ms, extra long beep = 1000 ms.	

Downloading and Installing Software Updates

Following are instructions for downloading software updates from the internet and installing the updates onto the SOLUS PRO™ scan tool.

C.1 Check for Service Upgrades Before Use

To download and install software service upgrades you need a personal computer (PC) running ShopStream Connect™ software, which is a free downloadable program.

Improved versions of the operating system software for your handheld diagnostic tool periodically become available at no cost to you. These “service upgrades”, which are the result of an ongoing research and development program, are available through the internet. It is important to check for available upgrades before using your diagnostic tool for the first time, and on a regular basis after that, to ensure you have the latest version of the software.

Following are procedures for:

- Verifying your PC meets the minimum requirements for ShopStream Connect™ software
- Downloading and Installing ShopStream Connect™ software on your PC
- Downloading service upgrades to your SOLUS PRO scan tool

C.2 Verifying Minimum PC Requirements

IMPORTANT:

If your PC does not meet the minimum requirements, do not attempt to install the ShopStream Connect software.

Before installing the software, verify your PC meets the following requirements:

- System Properties:
 - Operating system—Microsoft Windows 2000 Service Pack 4, Windows XP, or Vista. The system must be upgraded to Microsoft .NET Framework Version 2.
 - Processor—Pentium 4 or later, or equivalent
 - Memory—256 MB minimum, 512 MB recommended
- Hard Drive—50 MB free space
- CD-ROM, DVD, or DVD-ROM drive
- USB 2.0 or later
- Internet Explorer 6.0 or higher
- Internet connection
- Adobe Reader software (free download at www.adobe.com/products/reader)

A type mini A USB cable is also needed to connect the SOLUS PRO scan tool to the PC.

C.2.1 Verifying PC System Properties

Follow the procedures below to check your PC system properties and to determine how much free space is available on your hard drive.



To check your PC system properties:

1. On the Desktop, right-click **My Computer** to open the menu.
2. Select **Properties** from the menu.

The **System Properties** dialog box displays with your system information (Figure C-1).

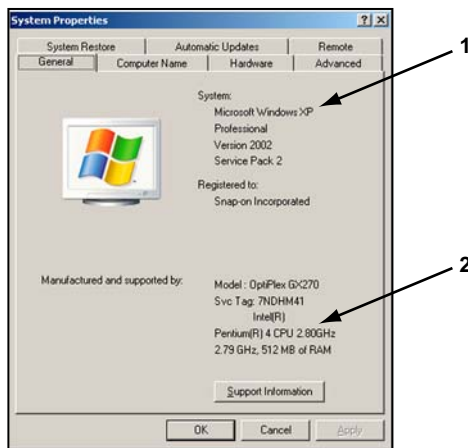

- 1— System property information
- 2— Hard drive information

Figure C-1 Sample Windows XP System Properties dialog box



To check PC hard drive free space:

1. On the Desktop, double-click **My Computer**.
2. Select **View > Details** (Figure C-2).

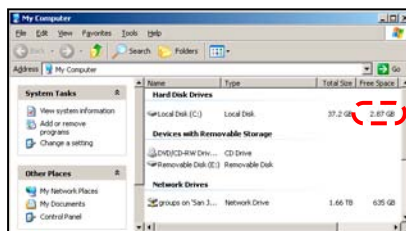

Figure C-2 Sample PC hard drive free space details

C.3 Downloading and Installing ShopStream Connect

Follow the procedure below to download the ShopStream Connect software.



To download the software:

1. From your PC, go to <http://diagnostics.snapon.com/scc> using your Internet browser.
2. Locate the ShopStream Connect software download.
3. Follow the on-screen instructions.

After downloading, follow the procedures below to install the ShopStream Connect software onto your PC.



To install the ShopStream Connect software:

1. Locate the ShopStream Connect software installer on the PC and double-click **ShopStreamConnect.exe**



NOTE:

C:\Program Files\ShopStream Connect is the default download location.

2. When the welcome screen displays (Figure C-3), select **Next**.

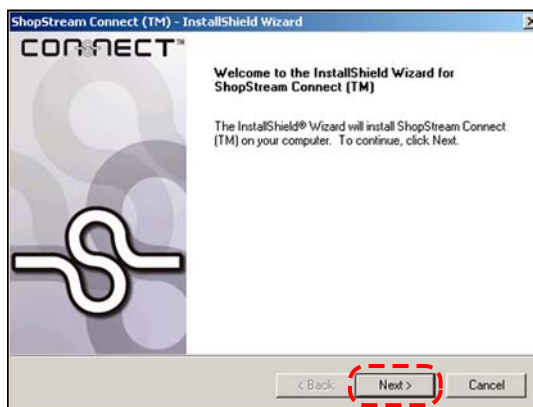

Figure C-3 Sample Welcome screen

The License Agreement screen displays (Figure C-4).

3. Highlight **I accept the terms of the license agreement** and select **Next** to continue.

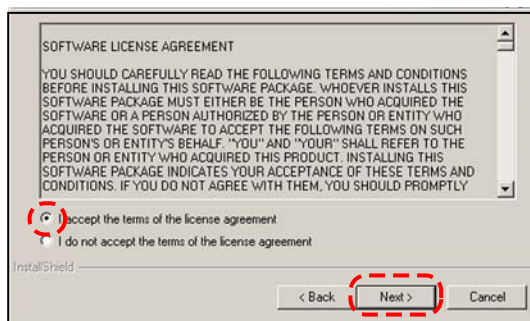

Figure C-4 Sample License Agreement screen

The Choose Destination Location screen displays. It is highly recommended to allow the software to install in the default location.

4. Select **Next** to continue.
5. Select **Install** when the Ready to Install the Program screen displays to begin the installation.

The Setup Status screen tracks progress as the program installs (Figure C-5).

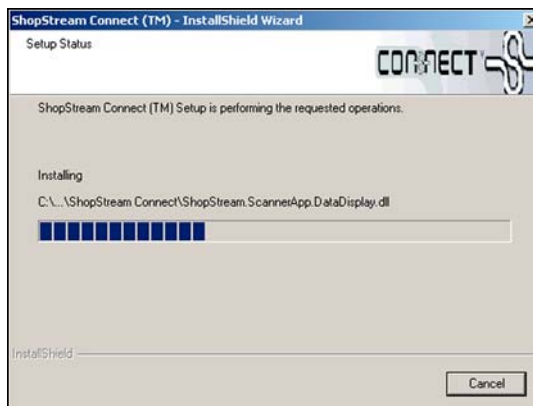

Figure C-5 Sample Setup Status screen

- 6. When the Complete screen displays, select **Finish** to close the Install Wizard (Figure C-6).

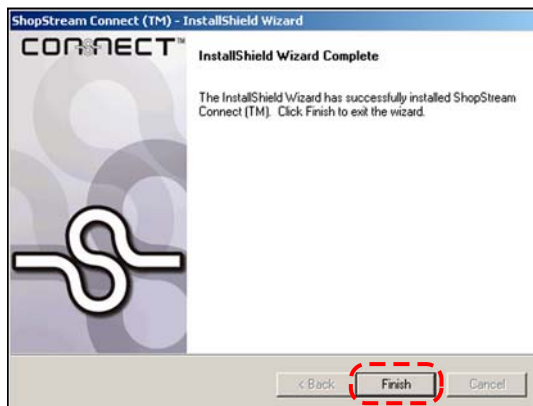

Figure C-6 Sample Complete screen

A ShopStream Connect shortcut icon is added to your desktop (Figure C-7), double-click the icon to launch the ShopStream Connect software.



Figure C-7 Sample ShopStream Connect Desktop icon

C.4 Downloading Service Upgrades

The ShopStream Connect software allows you to download service upgrades directly to your handheld diagnostic tools, as well as update its own software. The following pages contain a brief description for installing a service upgrade on a handheld tool. Detailed procedures for updating the ShopStream Connect software, connecting handheld diagnostic tools to the PC, and other

operations are found in the ShopStream Connect User's Manual. The ShopStream Connect User's Manual is available from the Help button on the ShopStream Connect toolbar (Figure C-8).

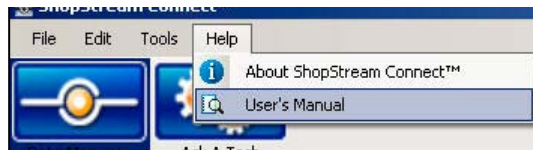

Figure C-8 Sample ShopStream Connect help menu

C.4.1 Before You Begin

Prior to downloading a service upgrade, be sure to have the following items on hand:

- A PC with ShopStream Connect software and an internet connection
- The AC/DC Power Supply for the SOLUS PRO scan tool
- A type mini A USB cable

IMPORTANT:

An uninterrupted power source to the diagnostic tool is crucial during an upgrade, as any loss of power may damage the tool and render it inoperative. Therefore, use of the AC/DC Power Supply is highly recommended. Do not rely on partially-charged batteries.

C.4.2 Installing a Service Upgrade

Once you have the required items available, use the procedure below to install an upgrade.



To install a service upgrade:

1. Connect the AC/DC Power Supply to the DC power supply input port on SOLUS PRO and a reliable power source.
2. Power on the SOLUS PRO scan tool.
3. From the SOLUS PRO main menu, select **Utilities > Connect to PC** to place the scan tool in Connect to PC mode.
4. Connect the USB cable between the mini USB port on top of the SOLUS PRO scan tool and USB port on the PC.

A "Removable Disk" window may automatically open on the PC (Figure C-9). If so, select **Cancel** to close the window.

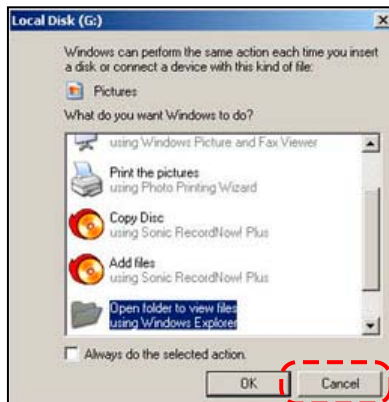

Figure C-9 Sample removable disk window

- 5. Double-click the desktop icon to launch ShopStream Connect (Figure C-7).
- 6. Once ShopStream Connect opens; select Tools > Update Software > SOLUS PRO from the Menu bar (Figure C-10).

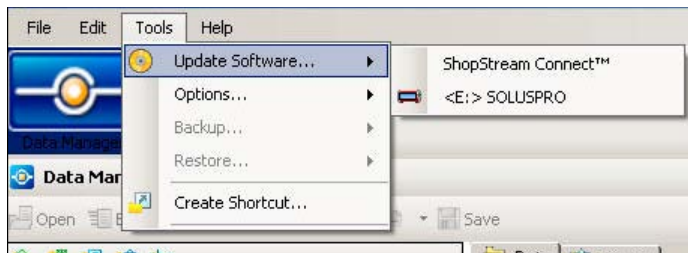

Figure C-10 Sample Update Software menu

When connectivity is established with the Snap-on Web server, a check for updates confirmation message displays (Figure C-11).

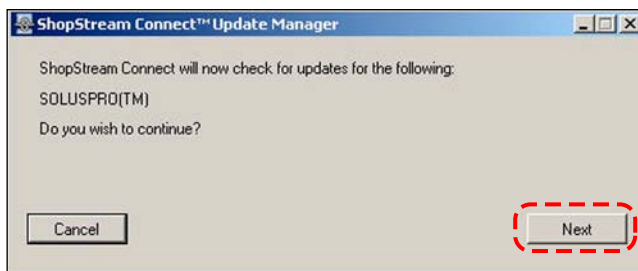

Figure C-11 Sample Check for updates screen

- 7. Select **Next** to continue and the software checks to see if an upgrade is available:
 - a. If no upgrades are available, a screen similar to Figure C-12 displays. Select **Finish** to close the Update Manager, then skip ahead to Step 7.

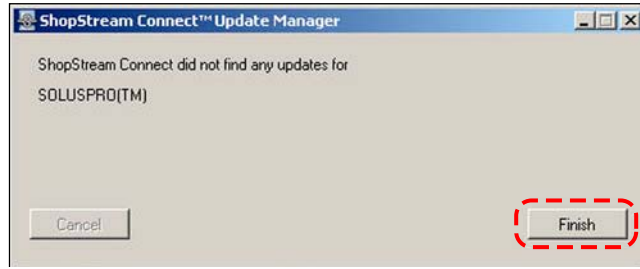

Figure C-12 Sample no updates available screen

- b. If an upgrade is available, a screen similar to Figure C-13 displays. Select **Download** to begin the upgrade process and continue to Step 6.

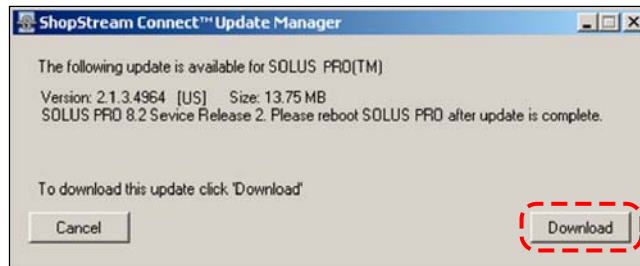

Figure C-13 Sample update available screen



NOTE:

Each service upgrade is unique. The time involved will vary and some additional steps may be required. Follow any on-screen instructions to complete the process.

8. When the “complete” message displays, select **Finish** to close the Update Manager.
9. Remove the USB cable to disconnect the tool from the PC.
10. Press the **Power** button on SOLUS PRO to exit Connect to PC mode.
 The upgrade is now downloaded, but not installed. The installation process automatically begins when SOLUS PRO is powered on. SOLUS PRO should automatically reboot after exiting Connect to PC mode. If not, power on the tool.
11. After SOLUS PRO powers on, the upgrade installation begins. The install may take several minutes and a series of screens tracks the progress. Do not press any buttons or disrupt power during the installation.
 When the main menu displays, the installation is complete and your SOLUS PRO scan tool is ready for use.

Index

A

AC power adapter 12
actuator tests 30
adapters. *See* test adapters
Auto scale 40
auto scroll 50
auxiliary power cables
 battery power cable 13
 lighter power cable 13
 vehicle power 11, 16

B

battery pack
 about 11
 charger 11
 charging 17
 disposing of 64
 extending the life of 18
 installing 18
 low battery warning 18
 not charging 68
 replacing 64
 time to charge 18
 using 16–18
 working when battery is low 18
battery pack specifications 6
battery power cable. *See* auxiliary power cables
beep code definitions 69
brightness/contrast 5, 20
 See also buttons
buffer bar 24
buttons 5, 8

C

cables 12
casing hook 6
changing screen views 34–40
 See also upper toolbar
cleaning the unit 64
Clear button 36, 43
clearing codes 32
Codes & Data selections 30
 See also data parameters
Codes Menu 30, 31–33
codes. *See* diagnostic trouble codes (DTCs)
color theme setting 60
CompactFlash®
 and software updates 61

CompactFlash® cards
 application 62
 slot locations 5
 slot technical specs 6
 special applications 62
component tests 30, 33
confirmation messages 26
connecting to a computer 20
connecting to a vehicle 27, 29
connecting to vehicle power 15, 16
copying data 50
cursors 44
Custom Setup 53
customizing a data list 54

D

damage inspection 64
Data buffer
 clearing 36, 43
data cable 13
 See also power supply
data cable connector 5, 10
data cable extension
 accessory 13
Data Display 30
Data Display selections 31
Data Management screen 48
data parameters
 changing views 34
 customizing list 54
 displaying 30, 31
 Graph views 38
 pausing 43
 PID List view 35
 reviewing 36
 Text view 38
data storage CF card 6
date setting 58
DC power input
 AC/DC power supply 10
DC power jack
 location 5
deleting saved files 50
diagnostic trouble codes (DTCs) 30
disposal requirements 64
DTC status 32

- E**
 - Easy Scroll 26, 61
 - error messages 26
 - exiting Scanner mode 34
- F**
 - forced shut down 69
 - Freeze Frame/Failure Records 32
 - frequently asked questions 66
 - functional tests 30, 33
- G**
 - generic functions 30, 33
 - getting started 14
 - graphing data 34–45
 - changing views 34
 - Graph mode 38–45
 - parameter menu 38
- H**
 - handgrips 5
 - hanging position. *See* stand
- I**
 - identifying a test vehicle 27, 28
 - information tests 33
 - inspecting unit for damage 64
- L**
 - LCD screen 5
 - lighter power cable. *See* auxiliary power cables
 - loading saved data 49
 - lock PID 37
 - locking data parameters 39
- M**
 - main body 24
 - Main Menu (System) 30
 - maintenance
 - battery pack 64
 - maintenance tips 64
 - making selections 25
 - manual conventions
 - description 1
 - notes 2
 - Manual scale 40
 - manuals, software 3
 - manufacturer
 - selecting 27
 - manufacturer selection (vehicle) 27, 28
- N**
 - Mini USB port
 - connecting to PC 10
 - moving saved data 50
 - navigating 22–25
- O**
 - operating temperature range 7
 - operations 27
 - connecting to a vehicle 27, 29
 - identifying a test vehicle 27, 28
 - selecting a system to test 27, 29
 - selecting tests 27, 30
 - selecting the manufacturer 27
 - optional accessories 13
- P**
 - parameter menu 38
 - clear all trigger levels 39
 - clear trigger levels 39
 - lock 39
 - scale 39
 - set trigger levels 39
 - parameters. *See* data parameters
 - Pause/Play button. *See* upper toolbar
 - pausing data 36, 43
 - PC, connect to 62
 - Personality Key™ 68
 - PID lists
 - locking 37
 - unlocking 38
 - PID triggering 42
 - PIDs. *See* data parameters
 - Play button. *See* upper toolbar
 - Power button. *See* buttons
 - power cables. *See* auxiliary power cables
 - Power Management options 56
 - power options 20
 - power supply
 - connecting to 15–19
 - connecting to vehicle power 16
 - types 10–12
 - powering up the unit 19
 - printer setup 19
 - printing 52–53
- R**
 - reset tests 33
 - Review button 49
 - review PID 36

S

- S button 9
 - location 5
 - See *also* Utilities
- S button setting 59
- Safety iii–iv
- safety
 - information iii
 - message conventions iii
- safety messages iii–iv
- Saved Data
 - capturing 45
- saved data
 - identifying 48
 - viewing 47
- saving data 45–47
- Scale all 40
- scanner button 23
- Scanner mode
 - exiting 34
- Scanner units 53–54
- Scanner View 60
- screen layout 22
- screen messages 26
- selecting a system to test 27, 29
- selecting tests 27
- self-tests 30
- service codes 30
- service upgrades
 - checking for 70
 - downloading 73–74
 - installing 74–76
- set trigger levels 41
- Shop Info 62
- ShopStream Connect 20, 71–73
- shutting down the unit 9, 20
- snapshot preferences, adjusting 57
- software
 - exiting 34
 - updates 70
- software manuals 3
- software updates 61, 70–76
- Sorting data 43
- stand 6, 7–8
- Status Bar 25
- storage temperature range 7
- storage tips 64
- subsystem tests 33
- supplying power. See *power supply*
- System Info option. See *Utilities menu*
- system information
 - displaying 63
 - Utilities button 55
- system tests 30, 33

T

- Technical specifications 6–7
- temperature range specifications 7
- terminating vehicle communication 34
- test adapters 13, 15, 16, 68
- tests
 - actuator 30
 - component 30, 33
 - functional 30, 33
 - selecting 27, 30
 - subsystem 33
 - system 30, 33
- Thumb Pad 5, 8
 - See *also* buttons
- time setting 58
- time zone setting 58
- toggle tests 33
- tool setup
 - save data 57
- Tool Setup menu. See *Utilities menu*
- toolbar. See *upper toolbar*
- Tools Button 53
- trigger
 - clearing levels 43
 - condition 41
 - delay 42
 - disarming 43
- Trouble Codes 31
- trouble codes. See *diagnostic trouble codes (DTCs)*
- troubleshooting tips 68
- turning off the unit 20

U

- unit operations. See *operations*
- unlock all 39
- unlock all PIDs 40
- unlock PIDS 39
- upper toolbar
 - buttons and functions 22
 - Cursor button 44
 - navigating 25
 - Pause/Play button 36
 - Print button 52
 - test controls 22
 - Tools button 53
 - View button 34
- USB port
 - connecting to PC 10
 - location 5

Utilities menu 55
 Connect to PC 62
 Easy Scroll 61
 Run... 62
 Scanner View 60
 Shop Info 62
 software update 61
 System Info 63
 Tool Setup menu 56-60

V

variable control tests 33
Vehicle Communication menu 28
vehicle diagnostic connectors 13, 16, 29
vehicle identification. See identifying a test vehicle
vehicle power. See power supply
Viewing saved data 47-52

W

warning messages 26

Y

Y button. See buttons