

ETHOS® Tech

User Manual



Legal Information

Trademarks

Snap-on is a trademark, registered in the United States and other countries, of Snap-on Incorporated. This publication contains many Snap-on Incorporated trademarks, including but not limited to Snap-on, and ShopStream. All other marks are trademarks or registered trademarks of their respective holders.

Copyright Information

© 2018 Snap-on Incorporated. All rights reserved.

Disclaimer of Warranties and Limitation of Liabilities

All pictures and illustrations shown are for reference purposes only. All information, specifications and illustrations in this manual are based on the latest information available at the time of printing and are subject to change without notice. While the authors have taken due care in the preparation of this manual, nothing contained herein:

- Modifies or alters in any way the standard terms and conditions of the purchase, lease, or rental agreement under the terms of which the equipment to which this manual relates was acquired.
- Increases in any way the liability to the customer or to third parties.

Snap-on® reserves the right to make changes at any time without notice.

IMPORTANT:

Before operating or maintaining this unit, please read this manual carefully paying extra attention to the safety warnings and precautions.

Software License Information

Use of Software is governed by the terms and conditions of the End User License Agreement. The diagnostic tool should not be initially operated until the End User License Agreement is read. Use of the device acknowledges your acceptance of the End User License Agreement. The Snap-on Incorporated Software End User License Agreement may be provided with the diagnostic tool, and is available at: <https://eula.snapon.com/diagnostics>.

Patent Information

For a listing of Snap-on products that are protected by patents in the United States and elsewhere, visit: <https://patents.snapon.com>

User Manual Information

This manual includes information and images applicable with diagnostic software version 18.4 and later. Some information within this manual may not be applicable with other diagnostic software versions.

The information in this manual is periodically revised to ensure the latest information is included. The current version of this manual and other technical documentation is available online from Snap-on Diagnostics.

Product Support Information

Phone / E-mail - Technical Assistance

1-800-424-7226 / diagnostics_support@snapon.com

or use our online contact form

- <https://www1.snapon.com/diagnostics/us/Contact>

Website Links:

Snap-on Diagnostics and Information

- <http://diagnostics.snapon.com>

Manuals / Technical Documentation - This manual is periodically revised to ensure the latest information is included. Download the latest version of this manual and other related technical documentation at:

- <http://diagnostics.snapon.com/usermanuals>

For technical assistance in all other markets, contact your selling agent.

Product Training Videos

Diagnostic tool specific training videos are available on our website. Follow along and learn the basics of diagnostic tool operation with our free training videos.

Videos are product specific and are available at:

<http://diagnostics.snapon.com> - Click on the "Training & Support" tab, select the applicable diagnostic tool, then select "See Training".



NOTE:

Sample titles are listed below. Not all titles may be available for all diagnostic tools, and are subject to change.

| Snap-on® Training Solutions® - Training Videos (examples) | |
|---|---------------------------------|
| Introduction and Navigation | Global OBD-II |
| Scanner Codes | Digital Multimeter |
| Scanner Data in PID View | Graphing Multimeter & Lab Scope |
| Scanner Data in Graphing View | Guided Component Tests |
| Fast-Track® Troubleshooter | Vehicle Specs & Resets |
| Functional Tests | SureTrack® & Wi-Fi |

Diagnostic Quick Tips - Video Series

Snap-on Diagnostic Quick Tips videos are available at no charge on our website and on our YouTube channel. These videos are developed from real repair case studies to help professional technicians use diagnostic tools to solve specific vehicle problems (e.g. performing a Ford Relative Injector Flow Test).

Additional videos are also available showing specific diagnostic tool features (e.g. ShopStream Connect - Software Updates).



Figure 1-1

Videos are available at:

<http://diagnostics.snapon.com> - Click on the “Training & Support” tab, select the applicable diagnostic tool, then select “See Quick Tips”

<https://www.youtube.com/user/snaponscanner/videos> - Use the search function to find a title, or enter “Diagnostic Quick Tips” in the search field to see a list of all applicable titles.



NOTE:

URL links (above) and titles listed (below) are subject to change and may not be available in all markets.

A sample list of titles are listed below, other titles may be available.

Some videos may not be applicable for use with all diagnostic tools.

| Snap-on® Training Solutions® - Diagnostic Quick Tips Videos (examples) | |
|--|---|
| Air/Fuel Ratio Sensor Test | Fuel Injector Voltage and Current Tests (Scope) |
| Alternator Ripple Test (Scope) | Fuel Pump Current Ramp Test (Scope) |
| BMW® Rain Sensor Calibration | Harley-Davidson® ABS Brake Bleed |
| CAN Bus Diagnostics (Scope) | Harley-Davidson® Functional Tests |
| Chevrolet® Volt Coolant Pump Bleed | Harley-Davidson® Key Fob Programming |

| Snap-on® Training Solutions® - Diagnostic Quick Tips Videos (examples) | |
|---|---|
| Chrysler HVAC Test | Hyundai Blind Spot Detection System Calibration |
| Chrysler VVT System Cleaning | Hyundai Occupant Detection System Reset |
| Chrysler Wheel & Tire Calibrations | Ignition Coil Current and Voltage Comparison |
| COP Ignition Test | Ignition Coil Current Ramp Test |
| Dual Screen Diagnostics: Scanner vs. Scope | Ignition Coil Primary Voltage Test |
| Electronic Throttle Control System Diagnostics | Ignition System Diagnostics Using the SIA2000 (Scope) |
| FIAT® 500 Proxi Alignment | MINI Battery Relearn |
| FIAT® 500 Throttle Body Relearn | Multi Channel Cam / Crank Correlation |
| Flex Ray Bus Diagnostics | OBD-II Mode 10 Permanent Codes |
| Ford Battery Monitor System | Oil Specs & Service Light Resets |
| Ford Coil Current RFI Test (Scope) | PID Trigger Functions (Scanner) |
| Ford Flash Reprogramming | Piezo Injectors Signature Test |
| Ford Misfire Monitor Neutral Profile Correction (Scanner) | Relative Compression Test (Scope) |
| Ford PATS Key Programming | ShopStream Connect - Data Manipulation |
| Ford Relative Compression Test | ShopStream Connect - Software Updates |
| Ford Relative Injector Flow Test | Speed Up Your Diagnostics (Scanner) |
| Ford TPMS Reprogramming | The Power of Troubleshooter Tips (Scanner) |
| Ford® 6.7L Transmission Solenoid Characterization | Top Level Menus: Built In Scope Training |
| Ford® Diesel Injector Coding | Toyota EVAP Test |
| VW / Audi Flexible Service Reset (Scanner) | Toyota Multiple Freeze Frame (Scanner) |
| | Toyota Transmission Compensation Coding |

Contents

| | |
|--|-----------|
| Safety Information | 4 |
| Chapter 1: Using This Manual | 6 |
| Content | 6 |
| Conventions | 6 |
| Terminology | 6 |
| Symbols | 6 |
| Bold Text | 7 |
| Notes and Important Messages | 7 |
| Hyperlinks | 7 |
| Procedures | 7 |
| Chapter 2: Introduction | 8 |
| Control Buttons | 9 |
| Data and Power Connections | 10 |
| Battery Cover and Stand | 10 |
| Power Sources | 11 |
| Batteries | 11 |
| AC Power Supply | 11 |
| Vehicle Power | 11 |
| Technical Specifications | 12 |
| Chapter 3: Basic Operation and Navigation | 13 |
| Installing the Batteries | 13 |
| Turning On/Off and Emergency Shutdown | 14 |
| Turning On | 14 |
| Turning Off | 14 |
| Emergency Shutdown | 15 |
| Basic Navigation | 15 |
| Home Screen Layout | 15 |
| Title Bar | 16 |
| Home Screen Icons | 17 |
| Common Toolbar Control Icons | 18 |
| Scroll Bar | 19 |
| Screen Messages | 20 |
| System Messages | 20 |
| Communication Messages | 20 |
| Data Cable Connection | 21 |
| Chapter 4: Scanner | 22 |
| Screen Layout and Toolbar Icons | 22 |
| Screen Layout | 22 |
| Scanner Control Icons | 23 |
| Scanner Demonstration Program | 23 |
| Scanner Operation | 24 |

| | |
|--|-----------|
| Vehicle Identification | 24 |
| Connecting the Data Cable | 25 |
| System and Test Selection | 26 |
| Exiting Scanner | 42 |
| Chapter 5: OBD-II/EOBD | 43 |
| Basic Operations | 43 |
| Screen Layout and Toolbar Controls | 43 |
| Connecting the Data Cable | 43 |
| Saving and Reviewing Data Files | 43 |
| OBD-II/EOBD Menu | 43 |
| OBD Direct | 43 |
| Chapter 6: Previous Vehicles and Data | 50 |
| Previous Vehicles and Data Menu | 50 |
| Vehicle History | 50 |
| View Saved Data | 51 |
| Viewing Codes and Code Scan Results | 52 |
| Delete Saved Data | 53 |
| Chapter 7: Tools | 54 |
| Tools Menu | 54 |
| Connect-to-PC | 55 |
| Configure Shortcut Button | 55 |
| System Information | 57 |
| Settings | 57 |
| Chapter 8: Maintenance | 67 |
| Cleaning and Inspecting | 67 |
| Cleaning the Touch Screen | 67 |
| Battery Service | 67 |
| Battery Safety Guidelines | 67 |
| Replacing the Batteries | 68 |
| Disposing of the Batteries | 69 |
| Chapter 9: ShopStream Connect | 70 |
| Using SSC (Connecting to your PC) | 70 |
| SSC Main Screen | 71 |
| Scanner DataViewer | 72 |
| Image Viewer | 73 |
| Printing the Code Scan Report | 74 |
| Software Upgrades and Updates | 76 |
| End User License Agreement | 77 |
| Chapter 10: SureTrack Community | 78 |
| SureTrack - Online Community | 78 |
| Main Topic Links | 78 |
| Quick Reference | 78 |
| Finding your SureTrack Authorization Code | 79 |
| Creating a SureTrack Account | 80 |
| Logging In (active account) | 84 |

| | |
|--|----|
| Logging In with New Authorization Code (active account) | 85 |
| Logging In with New Authorization Code (expired account) | 86 |
| SureTrack Features | 88 |
| SureTrack Screens | 89 |

Safety Information

READ ALL INSTRUCTIONS

For your own safety, the safety of others, and to prevent damage to the product and vehicles upon which it is used, it is important that all instructions and safety messages in this manual and the accompanying *Important Safety Instructions* manual be read and understood by all persons operating, or coming into contact with the product, before operating. We suggest you store a copy of each manual near the product in sight of the operator.

For your safety, read all instructions. Use your diagnostic tools only as described in the tool user's manual. Use only manufacturer recommended parts and accessories with your diagnostic tools.

This product is intended for use by properly trained and skilled professional automotive technicians. The safety messages presented throughout this manual and the accompanying *Important Safety Instructions* manual are reminders to the operator to exercise extreme care when using this product.

There are many variations in procedures, techniques, tools, and parts for servicing vehicles, as well as in the skill of the individual doing the work. Because of the vast number of test applications and variations in the products that can be tested with this instrument, we cannot possibly anticipate or provide advice or safety messages to cover every situation. It is the responsibility of the automotive technician to be knowledgeable of the system being tested. It is essential to use proper service methods and test procedures. It is important to perform tests in an appropriate and acceptable manner that does not endanger your safety, the safety of others in the work area, the equipment being used, or the vehicle being tested.

It is assumed that the operator has a thorough understanding of vehicle systems before using this product. Understanding of these system principles and operating theories is necessary for competent, safe and accurate use of this instrument.

Before using the equipment, always refer to and follow the safety messages and applicable test procedures provided by the manufacturer of the vehicle or equipment being tested. Use the product only as described in its user manual. Use only manufacturer recommended parts and accessories with your product.

Read, understand and follow all safety messages and instructions in this manual, the accompanying *Important Safety Instructions* manual, and on the test equipment.

Environmental Conditions:

- This product is intended for indoor use only
- This product is rated for Pollution Degree 2 (normal conditions)

Safety Signal Words

All safety messages contain a safety signal word that indicates the level of the hazard. An icon, when present, gives a graphical description of the hazard. Safety Signal words are.

DANGER

Indicates an imminently hazardous situation which, if not avoided, will result in death or serious injury to the operator or to bystanders.

WARNING

Indicates a potentially hazardous situation which, if not avoided, could result in death or serious injury to the operator or to bystanders.

CAUTION

Indicates a potentially hazardous situation which, if not avoided, may result in moderate or minor injury to the operator or to bystanders.

Safety Message Conventions

Safety messages are provided to help prevent personal injury and equipment damage. Safety messages communicate the hazard, hazard avoidance and possible consequences using three different type styles:

- Normal type states the hazard.
- **Bold type states how to avoid the hazard.**
- *Italic type states the possible consequences of not avoiding the hazard.*

An icon, when present, gives a graphical description of the potential hazard.

Safety Message Example

WARNING



Risk of unexpected vehicle movement.

- **Block drive wheels before performing a test with engine running.**

A moving vehicle can cause injury.

Important Safety Instructions

For a complete list of safety messages, refer to the accompanying *Important Safety Instructions manual*.

SAVE THESE INSTRUCTIONS

1.1 Content

This manual contains basic operating instructions and is structured in a manner to help you become familiar with your diagnostic tool features and perform basic operations.

The illustrations in this manual are intended as reference only and may not depict actual screen results, information, functions or standard equipment. Contact your sales representative for availability of other functions and optional equipment.

1.2 Conventions

The following conventions are used.

1.2.1 Terminology

The terms “Scanner” and “Scanner function” are used to describe the Scanner Function(s) of the diagnostic tool.

Examples:

- Select **Scanner** from the Home screen.
- From the Scanner main menu select **Continue**.
- The Scanner function provides many diagnostic tests.

The term “select” describes tapping/touching an icon on the touch screen, or highlighting an icon or menu choice and then selecting the confirmation menu choice such as **Continue, Accept, OK, Yes, or other similar** choice.

Abbreviated example for the following procedure: “Select **Brightness**”

1. Navigate to and highlight the **Brightness** selection.
2. Select **OK, or similar**, button.

1.2.2 Symbols

Different types of arrows are used. The “greater than” arrow (>) indicates an abbreviated set of selection (navigation) instructions.

Abbreviated example for the following procedure: “Select **Tools > Connect-to-PC**”

1. Select **Tools** from the home screen.
2. Highlight **Connect-to-PC** on the Tools menu.
3. Select **Connect-to-PC**.

The solid arrows (◀, ▶, ▼, ▲) are navigational instructions for the four directions of the directional buttons.

Example: Press the down ▼ arrow.

1.2.3 Bold Text

Bold emphasis is used in procedures to highlight selectable items such as control buttons, icons and menu options.

Example: Press the **OK** button.

1.2.4 Notes and Important Messages

The following messages are used.

Notes

A NOTE provides helpful information such as additional explanations, tips, and comments.

Example:

**NOTE:**

For additional information refer to...

Important

IMPORTANT indicates a situation which, if not avoided, may result in damage to the test equipment or vehicle.

Example:

IMPORTANT:

Do not disconnect the data cable while the diagnostic tool is communicating with the ECM.

1.2.5 Hyperlinks

Hyperlinks, or hot links, that take you to other related articles, procedures, and illustrations are available in electronic documents. Blue colored text indicates a selectable hyperlink.

Example:

IMPORTANT:

Read all applicable [Safety Information](#) before using this Diagnostic Tool!

1.2.6 Procedures

An arrow icon in the left-margin area indicates a procedure.

Example:

**To change screen views:**

1. Select the **Graph** icon.
The dropdown menu displays.
2. Select an option from the menu.
The screen layout changes to the format selected.

This multi-function diagnostic tool allows you to communicate with various vehicle control systems (e.g. engine, transmission, antilock brake system (ABS), body, instrument cluster, etc) to:

- Perform OEM specific functional tests and relearn procedures
- Retrieve and clear diagnostic trouble codes (DTCs)
- View parameter (PID) data in text or graph format, and save it for future review
- Set and arm PID triggers to automatically capture and save PID data to buffer memory
- Access global OBD-II/EOBD service modes, freeze frame data, readiness monitors, and more

In addition you can:

- Quickly retrieve previously tested vehicles, to save setup time during repeat testing
- Save screen shots, to quickly capture specific data for future review
- Interface with ShopStream Connect™ software on your PC to transfer files from the diagnostic tool to your PC, download software updates and more.

This chapter introduces the basic features of the diagnostic tool, including the control buttons, data connections, battery pack and power sources. Technical Specifications are provided at the end of this chapter.

2.1 Control Buttons

There are four “push type” control buttons and one “thumb pad rocker type” multi-directional button located on the right side of the Diagnostic Tool. All other Diagnostic Tool operations are controlled through the touch screen.

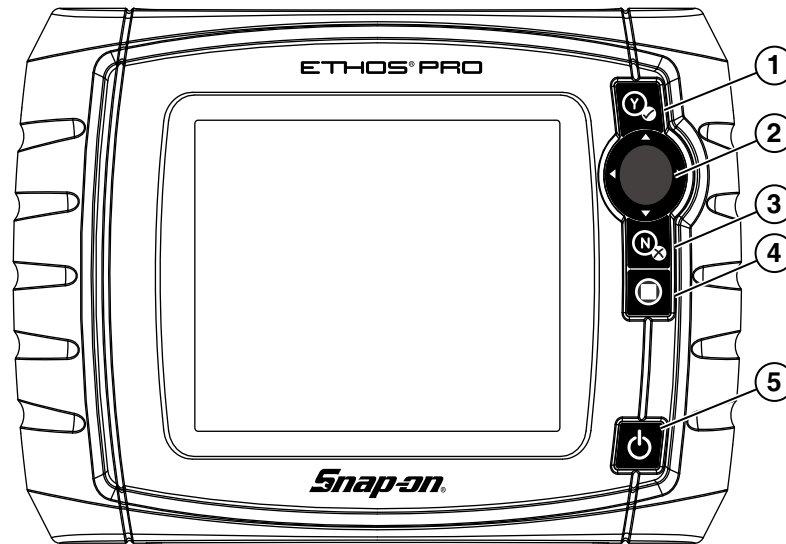

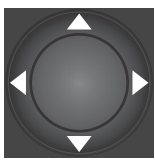





Figure 2-1 Front view

| Item | Button | Description | |
|------|---|--|---|
| 1 |  | Y/✓ or Accept - Push type button | <ul style="list-style-type: none"> To confirm a selection from a menu or program. To select an item that was highlighted using the direction arrows. To advance to the next screen in a series. To answer “Yes” when a yes or no choice is given. |
| 2 |  | Directional - Thumb pad rocker type buttons | Buttons move the cursor or highlight in their respective direction: <ul style="list-style-type: none"> Up (▲) Down (▼) Left (◀) Right (▶) |
| 3 |  | N/X or Cancel - Push type button | <ul style="list-style-type: none"> To exit a menu or program. To close an open list and return to the previous menu or screen. To answer “No” when a yes/no choice is given. |
| 4 |  | (Shortcut) - Push type button | Programmable function button that can provide a shortcut for performing a variety of routine tasks. Refer to Configure Shortcut Button , on page 55 for additional information. |
| 5 |  | Power (On/Off) - Push type button | Turns the Diagnostic Tool on and off. Also, press and hold for 5 seconds for emergency shutdown. |

2.2 Data and Power Connections

Connectors and jacks for data communication cables and the AC Power Supply are located on the top of the Diagnostic Tool.

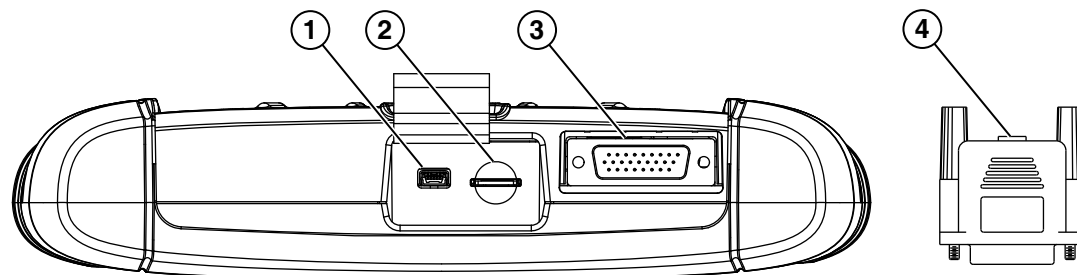
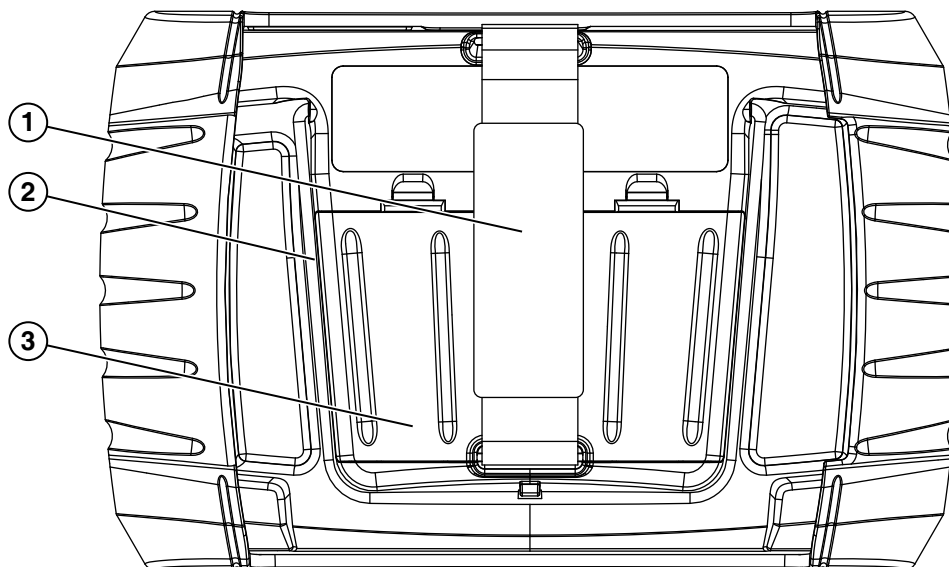

Figure 2-2 Top view

| Item | Description |
|------|--|
| 1 | Mini USB Jack - USB cable connection used to connect the Diagnostic Tool to a personal computer. |
| 2 | Micro secure digital (uSD) Card - contains operating system programming. IMPORTANT <i>The uSD card must be installed for the Diagnostic Tool to operate. Do not remove the uSD card while the Diagnostic Tool is powered on.</i> |
| 3 | Data Cable Connector - Data cable connection used to connect the Diagnostic Tool to a vehicle data link connector (DLC). |
| 4 | Power Supply Adapter - Used to connect the AC power supply to the Diagnostic Tool. |

2.3 Battery Cover and Stand



1— Hand Strap (Optional)

2— Built-in Stand (Optional) - The built-in stand extends from the back of the Diagnostic Tool and clips into the Diagnostic Tool for storage.

3— Battery Cover

Figure 2-3 Back view

An adjustable hand strap and a collapsible stand, that attach to the back of the Diagnostic Tool housing, are available as optional equipment.

The padded hand strap threads through mounting slots on the Diagnostic Tool housing. Velcro fasteners hold the strap in place and allow for quick adjustments. The strap keeps the Diagnostic Tool snug to the palm of your hand while working.

The stand extends from the back of the unit to allow hands-free viewing. The stand clips into the unit for storage and pivots out so that the display is at an angle when in use.

Contact your sales representative for availability of these and other options for personalizing your Diagnostic Tool.

2.4 Power Sources

Your Diagnostic Tool can receive power from any of the following sources:

- [Batteries](#)
- [AC Power Supply](#)
- [Vehicle Power](#)

2.4.1 Batteries

The Diagnostic Tool can be powered from the internal batteries. New standard batteries or fully charged rechargeable batteries provide sufficient power for about 2 hours of continuous operation.

IMPORTANT:

The internal batteries are not intended to power the Diagnostic Tool during vehicle testing. Make sure vehicle power is available to the Diagnostic Tool when performing vehicle tests.

2.4.2 AC Power Supply

The Diagnostic Tool can be powered from a standard AC outlet using the AC power supply. The connector on the end of the output cable of the AC power supply attaches to the data cable connector on top of the Diagnostic Tool. Use only the AC power supply provided.

2.4.3 Vehicle Power

All OBD-II/EOBD vehicles have vehicle battery power (B+) available on the DLC. The Diagnostic Tool is powered through the Data Cable when connected to the vehicle DLC. A green LED indicator on the DLC end of the data cable, illuminates when power is being supplied to the cable. If the LED fails to illuminate, check that the data cable is properly connected and then check the DLC power circuit. See [Data Cable Connection](#), on page 21 for additional data cable information.

An optional power cable may be required when testing non-OBD-II/EOBD models that do not have vehicle battery power (B+) available on the DLC. Contact your sales representative for availability.

2.5 Technical Specifications

| Item | Description / Specification |
|--|---|
| Touch Screen | Resistive Touch Panel |
| Display | 5.6 inch diagonal, LCD TFT |
| | 640 x 480 resolution SWVGA |
| | 24 bit color |
| Batteries | (6) 1.5V AA |
| Operating System | SMX |
| Processor | Motorola |
| DC Jack Operating Voltage | 8 to 32VDC |
| Width | 9.15 in. (232.4 mm) |
| Height | 5.85 in. (148.6 mm) |
| Depth | 1.85 in. (47.0 mm) |
| Weight (including batteries) | 2.0 lb (907 g) |
| Operating Temperature Range (ambient) | At 0 to 90% relative humidity (non-condensing) 32 to 113°F (0 to 45°C) |
| Storage Temperature (ambient) | At 0 to 70% relative humidity (non-condensing) -4 to 140°F (-20 to 60°C) |
| Environmental Conditions | This product is intended for indoor use only |
| | This product is rated for Pollution Degree 2 (normal conditions) |
| Power Supply | Supply Rating; 15 VDC, 2A |

Basic Operation and Navigation

This chapter describes basic Diagnostic Tool operation, navigation, screen layout, icon functions, and screen messages. Before you operate the Diagnostic Tool, make sure new batteries are installed or the Diagnostic Tool is powered by the AC power supply.

3.1 Installing the Batteries

The six AA batteries provided with your Diagnostic Tool kit must be installed before using the tool.



To install the batteries:

1. Depress the two battery cover lock tabs and lift off the battery cover.

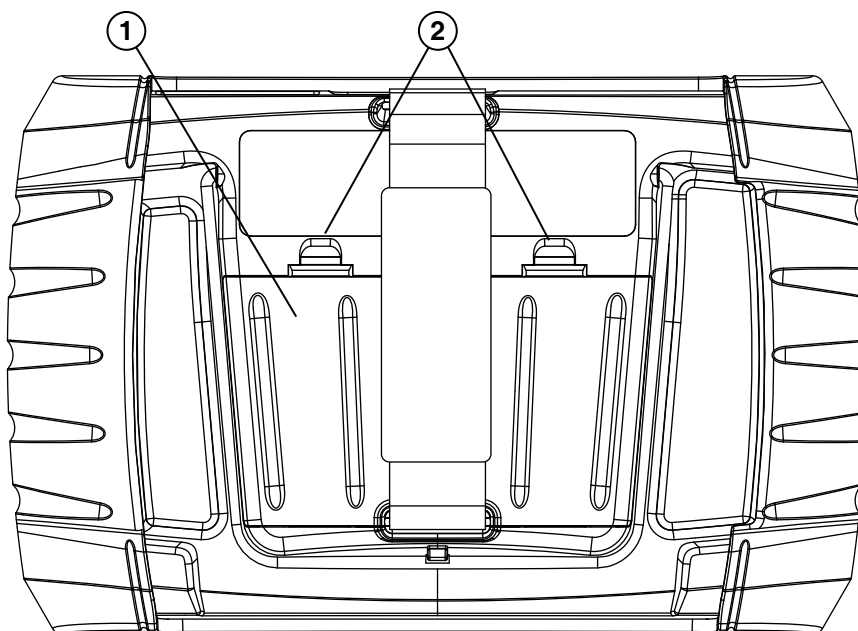

1— Battery Cover

2— Lock Tabs

Figure 3-1 Battery cover

2. Observing proper polarity (**shown on the battery slots**), install six new AA batteries.

IMPORTANT:

Your Diagnostic Tool can be damaged if the battery polarity is incorrect. Refer to the diagram in the battery compartment on the rear of the tool for correct battery polarity.

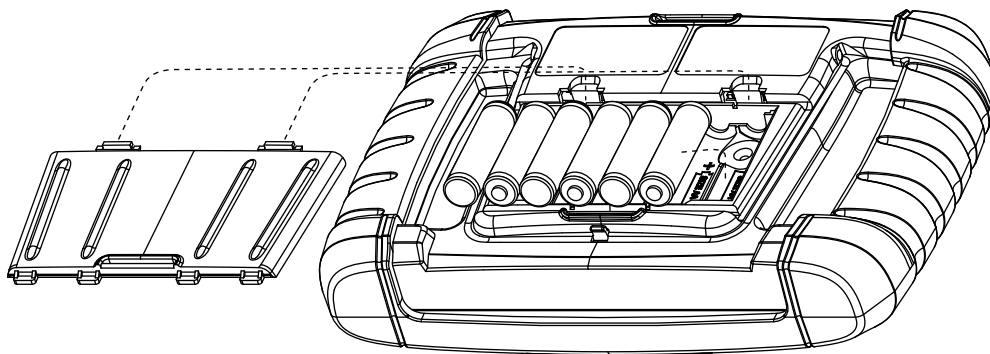

Figure 3-2 Installing batteries (battery cover removed)

3. Install the battery cover.

3.2 Turning On/Off and Emergency Shutdown

The following sections describe how to turn the Diagnostic Tool on and off and how to perform an emergency shutdown.

3.2.1 Turning On

The Diagnostic Tool will automatically turn on and open the Home screen (Figure 3-3) when power is supplied through the Data Cable or by the AC Power Supply. If the Diagnostic Tool does not automatically turn on, press and release the Power button on the front of the Diagnostic Tool to turn the Diagnostic Tool on.

3.2.2 Turning Off

IMPORTANT:

All vehicle communication must be terminated **BEFORE** turning off the Diagnostic Tool. A warning message displays if you attempt to turn the Diagnostic Tool off while communicating with the vehicle. Forcing a shut down while communicating may lead to ECM problems on some vehicles. Never disconnect the Data Cable when the Diagnostic Tool is communicating with the vehicle ECM.



To turn off the Diagnostic Tool:

1. Press the **N/X** button or select the **Back** or **Home** icon to navigate to the Home screen.
The “stopping communication” message appears briefly before the Home screen displays.
2. Disconnect the Diagnostic Tool Data Cable from the vehicle.
3. Press and release the **Power** button.
A confirmation screen displays.
4. Press the **Y/✓** button or select **OK** from the menu to turn the Diagnostic Tool off. To continue operating, press the **N/X** button or select **Cancel** from the menu.

3.2.3 Emergency Shutdown

IMPORTANT:

Using the emergency shutdown procedure while communicating with the vehicle ECM may lead to ECM problems on some vehicles.

During normal operation turn the Diagnostic Tool off using the *Turning Off* procedure above. The emergency shutdown procedure should only be used If the Diagnostic Tool does not respond to navigation or the control buttons, or exhibits erratic or abnormal operation. To force an emergency shutdown, press and hold the **Power** button for five seconds until the Diagnostic Tool turns off.

3.3 Basic Navigation

3.3.1 Home Screen Layout

The Home screen includes a title bar and main body. The Home screen contains icons, one for each of the primary Diagnostic Tool functions.

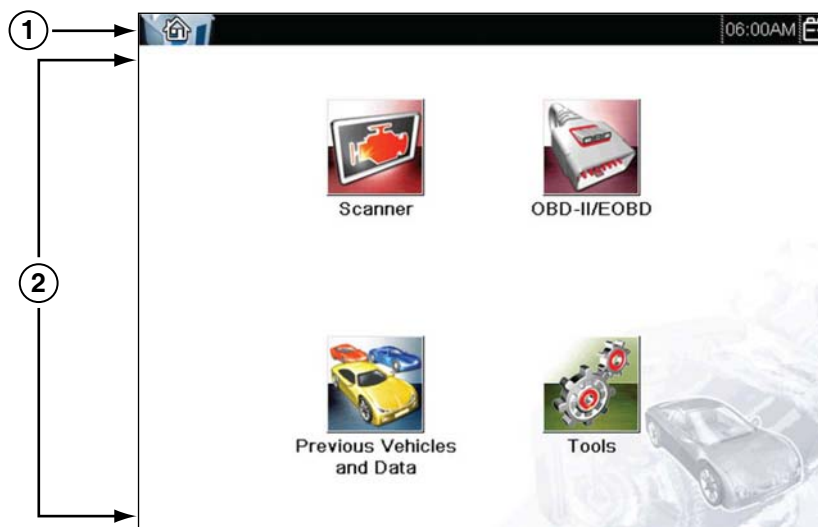

- 1— Title Bar
- 2— Main Body

Figure 3-3 Home screen

3.3.2 Title Bar

The title bar at the top of the screen provides basic information about current Diagnostic Tool operating conditions. Title bar options vary depending upon vehicle make and model, what function is active, what test is being performed, or what menu is selected. The title bar contains information only, there are no selectable items.

Elements of the title bar let you know at a glance:

- What Diagnostic Tool function is currently active.
- The current time.
- The source and status of the power being supplied to the Diagnostic Tool.





An active function icon is always displayed along the left-hand edge of the title bar. These icons resemble their Home screen icon counterparts in appearance and color. The name of the function displays to the right of the icon on some screens.

A real time clock displays to the left of the power supply icon. The clock is powered by a dedicated internal battery, so the correct time is maintained even when the main batteries are discharged. Use the Tools function to set the clock and format how time is displayed. See [Clock Settings](#), on page 63, for additional information.

The title bar displays other information that varies depending upon what functions are being performed. Other information may include:

- The identification (ID) of the test vehicle
- The name of the active menu or function
- The name of the test being performed

Table 3-1 Title Bar Icons





| Icon | Function | Icon | Function |
|---|---|--|---|
|  | Full Battery Charge Level - Indicates power is being supplied by the internal batteries. Horizontal bars diminish as the batteries discharge. |  | External Power Connected (AC Power Supply) - Indicates power is being supplied by the AC power supply. |
|  | Low Battery Charge Level - Indicates the internal batteries are low. A warning message will also display on the screen when the batteries get low. |  | Active Vehicle Communication - Indicates the Diagnostic Tool is actively communicating with a vehicle. |
|  | External Power Connected (Data Link Connector) - Indicates power is being supplied by the vehicle. | | |

3.3.3 Home Screen Icons

Each available Diagnostic Tool function is represented by an icon on the home screen. The table below provides descriptions of the icon functions.







Select an icon from the Home screen to launch a function. You can also use the control buttons to activate a function, a yellow border around the icon indicates it is highlighted, or in focus. Use the Directional buttons (◀, ▶, ▲, ▼) to highlight the desired function and then press the Y/✓ button to select it. A “please wait” message may display briefly, then automatically clear once the function is loaded and ready for use.

Table 3-2 Home screen icons

| Function Name | Function Icon | Description |
|------------------------------------|---|--|
| Scanner |  | Used to communicate with the electronic control systems of a vehicle. This function allows you to retrieve diagnostic trouble codes (DTCs), view PID data and perform diagnostic tests. See Scanner , on page 22, for details. |
| OBD-II/EOBD |  | Allows you to access generic OBD-II/EOBD data and tests without identifying the vehicle being tested. See OBD-II/EOBD , on page 43, for details. |
| Previous Vehicle & Data |  | Allows you to quickly reconfigure the Diagnostic Tool to a recently tested vehicle and to access saved data files. See Previous Vehicles and Data , on page 50, for details. |
| Tools |  | Allows you to adjust Diagnostic Tool settings to your personal preferences and perform other special functions. See Tools , on page 54, for details. |

3.3.4 Common Toolbar Control Icons

Common control icon functions are described in the following table. Specific function control icons are described in their applicable chapters. Displayed control icons vary depending on the active function or test. Select a control icon on a screen to activate a control function. You can also use the control buttons to activate a function, a yellow border around the icon indicates it is highlighted, or in focus. Use the Directional buttons (◀, ▶, ▲, ▼) to highlight the desired function and then press the Y/✓ button to select it.

| Icon | Function | Icon | Function |
|--|---|--|---|
|  | Back - Returns to the previously viewed screen. Icon is located on the left-hand edge of the toolbar. |  | Record - Indicates the data being displayed is paused and not being updated. Selecting resumes data collection. |
|  | Home - Returns to the Home screen. Icon is located next to the Back icon on the left side of the toolbar. |  | Tools - Opens the tools menu. |
|  | Save - Writes data from buffer memory to a file. The saved "movie" file can be accessed for future reference by selecting Previous Vehicles and Data > View Saved Data . | | |
| <i>The control icons below are used to navigate through paused or saved "movie" files during playback.</i> | | | |
|  | Step Forward - allows forward movement in singular steps. To quickly step forward, select this icon (yellow frame appears) then press and hold the Y/✓ button. (Note: To quickly step forward during Scanner data playback, press and hold the icon down until a red frame appears around the icon.) |  | Step Back - allows backward movement in singular steps. To quickly step backward, select this icon (yellow frame appears) then press and hold the Y/✓ button. (Note: To quickly step backward during Scanner data playback, press and hold the icon down until a red frame appears around the icon.) |

3.3.5 Scroll Bar

A vertical scroll bar appears along the right-hand edge of the screen when additional data expands above or below what is currently on the screen (Figure 3-4).

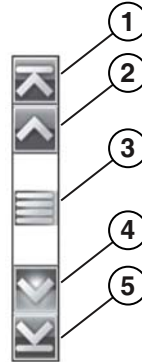

Figure 3-4 Scroll bar

- 1— **Beginning** - Moves to beginning of data displayed.
- 2— **Step up** - Moves up one increment of the data displayed.
- 3— **Slider (position indicator)** - Select and drag the **Slider** to scroll through data. The slider indicates the relative position of the current screen to the total available data.
- 4— **Step down** - Moves down one increment of the data displayed.
- 5— **End** - Moves to end of data displayed.

The Up (▲) and Down (▼) directional buttons can also be used to move through the data one line at a time. Press and hold a directional button to rapidly scroll through data.

3.4 Screen Messages

3.4.1 System Messages

There are four types of system messages that may be displayed:

| Message Type | Description |
|-------------------------------|---|
| Loading and Connecting | Loading and connecting messages display when the Diagnostic Tool is performing an internal operation, such as loading a database, establishing communications with the vehicle, or initiating a test. The message automatically clears once the internal operation is complete. |
| Confirmation | Confirmation messages inform you when you are about to perform an action that cannot be reversed or when an action has been initiated that requires a confirmation to continue. When a response is not required, the message displays briefly, then disappears. |
| Warning | Warning messages inform you when completing the selected action may result in an irreversible change or in the loss of data. A confirmation is required to continue. |
| Error | Error messages inform you when a system or procedural error has occurred, for example if the data cable becomes disconnected during operation. |

3.4.2 Communication Messages

When “no communication” messages are displayed, it indicates the Diagnostic Tool and the vehicle electronic control module are not communicating.

The following conditions cause “no communication” messages to display:

- The Diagnostic Tool is unable to establish a communication link with the vehicle.
- The vehicle is not equipped with the system that was selected.
- There is a loose connection.
- There is a blown vehicle fuse.
- There is a wiring fault on the vehicle.
- There is a circuit fault in the data cable or adapter.
- Incorrect vehicle identification was entered.

Refer to the Vehicle Communication Software manuals for manufacturer-specific problems.

3.5 Data Cable Connection

Connection of the data cable to the Diagnostic Tool and vehicle DLC is required for Scanner and OBD-II/EOBD testing.

Depending on the vehicle, the supplied DA-4 data cable may be used alone or may require optional adapters.

- **All OBD-II/EOBD compliant vehicles** - Use the supplied DA-4 data cable. The 26-pin end of the cable attaches to the data cable connector on the top of the Diagnostic Tool. The 16-pin end connects to the vehicle DLC. The cable connectors are secured with captive screws.
- **All non-OBD-II/EOBD (OBD-I) compliant vehicles** - Use the supplied DA-4 data cable with the optional DA-5 adapter and a manufacturer specific adapter. The 26-pin end of the cable attaches to the data cable connector on the top of the Diagnostic Tool. The 16-pin end connects to the DA-5 adapter, the DA-5 adapter connects to the manufacturer specific adapter and then connects to the vehicle DLC. The cable connectors are secured with captive screws.

On-screen cable and adapter connection instructions are provided while using the Scanner and OBD-II/EOBD functions. The instructions may also include the location of the vehicle DLC ([Figure 3-5](#)). If required, additional connection information can be found in the appropriate vehicle communication software manual for the vehicle. Vehicle communication software manuals are available online, see the website information at the front of this manual



Figure 3-5 Vehicle connection data cable message

For data cable vehicle power connection information, see [Vehicle Power](#), on page 11,.



To connect the data cable to the vehicle:

1. Follow the on-screen instructions for connecting to the vehicle ([Figure 3-5](#)).
2. Select **Continue** once the data cable is connected.
The Diagnostic Tool establishes communication then displays a list of available tests. If the Diagnostic Tool is unable to establish a communications link, a “no communications” message displays.
3. Select from the available tests to open a submenu of test options.

This chapter describes the basic operation of the Scanner function.

The **Scanner** icon is located on the Home screen.



The Scanner function allows your Diagnostic Tool to communicate with the electronic control systems of a vehicle. This allows you to retrieve diagnostic trouble codes (DTCs), view PID data and perform diagnostic tests.

4.1 Screen Layout and Toolbar Icons

The following screen layout and toolbar controls apply to both the Scanner and the OBD-II/EOBD functions.

4.1.1 Screen Layout

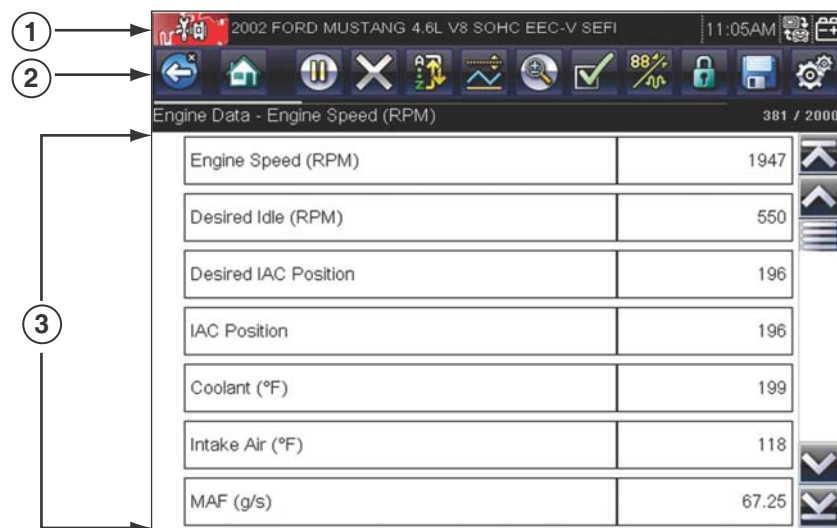









- 1— **Title bar**—shows active test, vehicle and Diagnostic Tool status
- 2— **Toolbar**—contains control icons
- 3— **Main Body**—displays menus, PID and test data

Figure 4-1 Screen layout

The Title bar appears for all functions and displays information only, there are no selectable items. Refer to [Title Bar](#), on page 16 for details.

4.1.2 Scanner Control Icons

The scanner toolbar contains control icons. Control icons may vary depending on the active function or test. A yellow frame surrounding an icon (highlighted), indicates it is selected. Other control icons (not shown) are described in [Common Toolbar Control Icons](#), on page 18.

| Icon | Function | Icon | Function |
|---|---|--|--|
|  | Pause - Indicates PID data from the vehicle is being displayed. Selecting pauses data collection. |  | Custom Data List - Opens a menu for selecting which PIDs display in the list. |
|  | Clear - Erases all the PID data in the buffer and begins a new recording. Selecting opens a confirmation message. |  | Change View - Changes display options between PID list or graph displays. |
|  | Trigger - Opens a menu that allows you to set, arm, and clear threshold values that automatically trigger PID data to be saved from buffer memory to a file. |  | Lock/Unlock - Locks or unlocks the highlighted parameter. Locked PIDs move to the top of the list and do not scroll as you move through the data. |
|  | Zoom - Incrementally increases and decreases the scale of the data being displayed. |  | Sort - Determines the order in which PIDs are listed on the screen. |

4.2 Scanner Demonstration Program

The Scanner demonstration program contains actual ECM PID data that allows you to navigate and become familiar with the many capabilities of the Scanner function without actually connecting to a vehicle. The following sections in this chapter provide detailed information on navigating through the Scanner function and various menus. As you navigate through the Demonstration program, refer to the applicable section for additional information.



To start the demonstration program:

1. From the Home screen, select the **Scanner** icon.
The manufacturer menu displays.
2. Select the **Demonstration** icon.

IMPORTANT:

Do not connect a vehicle to the Diagnostic Tool while using the Demonstration program.

3. Follow the on-screen instructions and make the selection as needed until the confirmation screen displays.
4. Select **OK** on the confirmation screen to load the demonstration database.
A message displays "Demo mode: Do not connect to vehicle."
5. Select **Continue**.
A systems menu, which shows all of the systems available for testing, displays.
6. Select a system from the menu, then select submenus as applicable to display the desired demonstration information.

4.3 Scanner Operation

Launching Scanner opens a menu list of vehicle manufacturers and begins the process by identifying the vehicle being tested. After the vehicle is identified, a vehicle system is selected and then a specific test or function is selected to allow you to retrieve diagnostic trouble codes (DTCs), view and save PID data, or perform diagnostic tests.



Basic Scanner Testing Procedure

1. **Launch Scanner**—Select the **Scanner** icon on the Home screen.
2. **Identify the vehicle**—Identify the test vehicle by selecting from the menu options.
3. **Connect the data cable to the vehicle**—Follow the on-screen connection instructions to connect the Diagnostic Tool to the test vehicle.
4. **Select the system**—Select the system to be tested from the systems menu.
5. **Select the test from the main menu**—Select the desired test.

4.3.1 Vehicle Identification

The Diagnostic Tool displays PID data provided by the vehicle ECM. The vehicle must be correctly identified for the Diagnostic Tool to communicate and display PID data correctly. The vehicle identification sequence is menu driven, follow the screen prompts to enter the information. Exact procedures may vary by the make, model, and year of the vehicle.



To identify a vehicle for testing:

1. Select the **Scanner** icon on the Home screen.
A list of manufacturers displays (Figure 4-2).

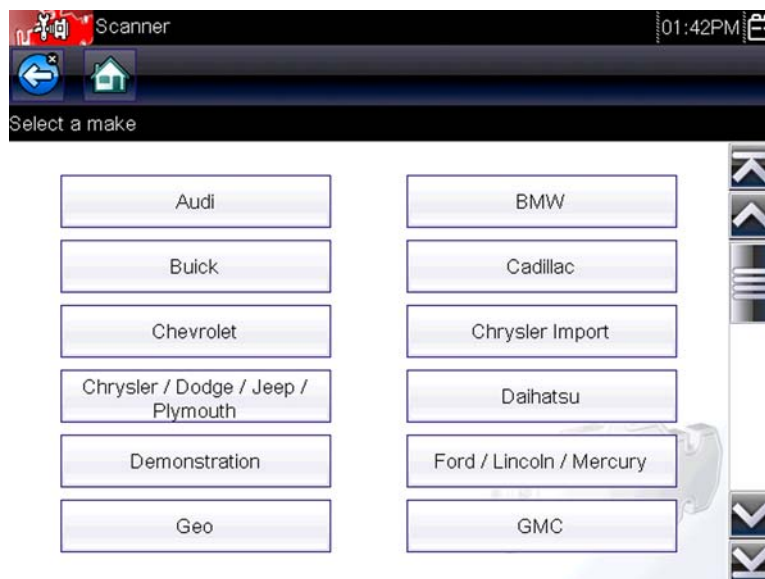

Figure 4-2 Manufacturer list

The list includes Demonstration, which opens the Demonstration program (see [Scanner Demonstration Program](#), on page 23).

2. Select the vehicle manufacturer from the list.
A model year menu displays.
3. Select the vehicle year from the menu.
A list of vehicle types or models displays. Several selections may be required to complete the vehicle identification, follow the screen prompts to enter the required information.
A confirmation screen displays once all the required information has been entered (Figure 4-3).

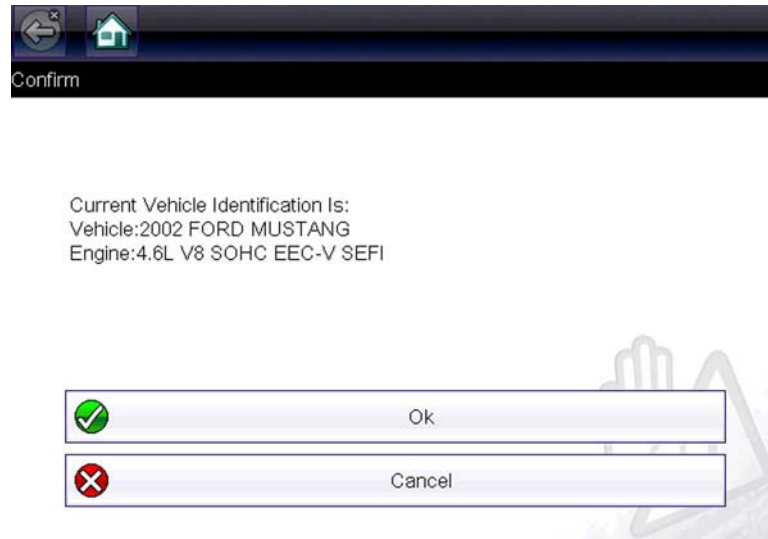

Figure 4-3 Vehicle confirmation screen

4. From the Confirm Vehicle screen select:
 - a. **OK** to continue.
 - b. **Cancel** to return to the previous screen.

4.3.2 Connecting the Data Cable

Connection of the data cable to the Diagnostic Tool and vehicle DLC is required for Scanner testing, see [Data Cable Connection](#), on page 21.

4.3.3 System and Test Selection

After a vehicle is selected, a menu of available systems is displayed. Select a system to continue.

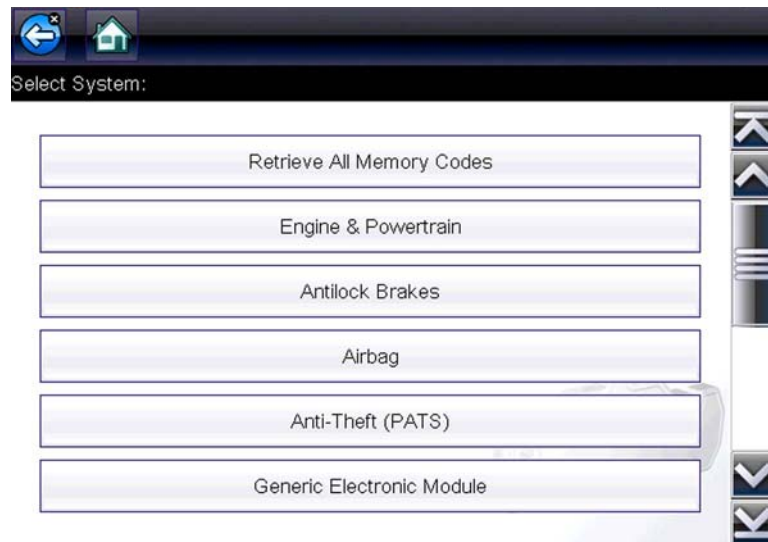

Figure 4-4 Available systems list



NOTE:

Only the systems available for testing on the identified vehicle are included in the list.

After a system is selected and the Diagnostic Tool establishes communication with the vehicle, a menu of available tests is displayed.

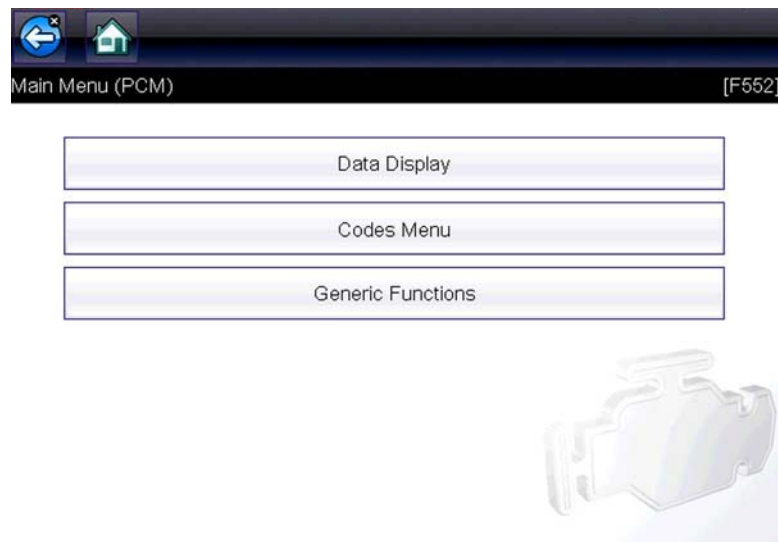

Figure 4-5 Main menu

Main menu options vary slightly by the year, make, and model of the test vehicle. The main menu may include:

- **Codes Menu**—displays diagnostic trouble code (DTC) records from the vehicle electronic control module. Selecting may open a submenu of viewing options.
- **Clear Codes**—erases DTC records and other data from the ECM. This selection is found on a Codes submenu for some models.
- **Data Display**— displays PID data from the vehicle electronic control module. Selecting may open a submenu of viewing options.
- **Functional Tests**—provides specific subsystem tests. The tests vary depending on the manufacturer and model.
- **Actuator Tests**—similar to functional tests, checks the operation of certain actuators, such as solenoid valves and relays.
- **Memory Resets**—allows you to reprogram adaptive values for certain components after making repairs. Selecting opens a submenu. These options are found on the Functional Tests Menu for some models.
- **System Tests**—provides specific subsystem testing. Performing these tests is similar to functional tests.
- **Generic Functions**—lets you access certain available Generic OBD II functions from a proprietary menu (1996 and newer vehicles only).

Codes Menu

This selection may appear as Codes, Codes Menu, Codes Only, Codes (No Data), Service Codes or something similar on the menu. Selecting opens a list of viewing options that includes:

- [Display Codes](#)
- [Clear Codes](#), on page 28
- [Freeze Frame/Failure Records](#), on page 29

Display Codes

Selecting opens either a list of diagnostic trouble codes (DTCs) stored in the selected vehicle electronic control module (ECM), or a submenu of DTC viewing options. A code list includes the DTC and a brief description ([Figure 4-6](#)).

| PCM | Memory Codes: |
|---------|---|
| P1260 | Theft Detected, Engine Disabled |
| P1000 | OBDII System Checks Incomplete |
| P0193 | Fuel Rail Pressure A Circuit High Input |
| P1233 | Fuel Pump Driver Module Off-Line |
| GEM/SJB | Memory Codes: |
| B1431 | Wiper Run Relay Coil Circuit Fault |

Figure 4-6 Data display screen

Submenu options may include:

- **Trouble Code Information**—opens a list of codes in ECM memory
- **History Codes**—opens a list of codes whose symptoms are not currently present. History codes indicate an intermittently occurring problem.
- **Failed This Ignition**—opens a list of codes that set during the current ignition cycle.
- **MIL SVS or Message Requested**—displays ECM requests to turn on the malfunction indicator lamp (MIL) or service vehicle soon (SVS) lamp, or display a driver information alert.
- **Last Test Failed**—displays a complete list of failed tests.
- **Test Failed Since Code Cleared**—displays a list of tests that failed since the last time codes were cleared from ECM memory.

Clear Codes

The Diagnostic Tool clears codes from the vehicle electronic control module memory on most vehicles. If this function is not available on the test vehicle, Clear Codes does not appear as a menu option.

**To clear codes:**

1. Select **Clear Codes** from the Codes Menu.
A confirmation message displays.
2. Make sure any conditions shown on the confirmation message are met, then select **Yes**.
A “codes cleared” message displays once the operation is complete.
3. Select **Continue** to return to the Codes Menu.

IMPORTANT:

Clearing codes erases all temporary ECM information, including Freeze Frame/Failure Records. Make sure no vital diagnostic information will be lost before clearing codes.

Freeze Frame/Failure Records

This selection displays the DTC that was set, along with corresponding data, when the ECM commanded the malfunction indicator lamp (MIL) to turn on.

Code Scan

One of the benefits of performing a code scan is that you can quickly show your customer diagnostic related issues with a pre scan report, and then after repairing the issues you can use the post scan report to show that the repairs were completed ([Figure 4-7](#)). In addition, by using ShopStream Connect the reports can be given to the customer and also saved for your own records, for more information, see [ShopStream Connect](#), on page 70.

IMPORTANT:

PRE / POST Scan Importance - As many systems do not turn on the check engine light or other indicator, performing a vehicle code scan before making any repairs may help in troubleshooting, by identifying possible unknown issues that may be related to the present symptoms.

Performing pre and post scans also allows you to record in report format the pre-condition of the vehicle and compare the post scan after work is complete to confirm the repairs were completed properly.

Pre and post scan is required by some manufacturers for pre and post collision work as well as by some insurance companies.

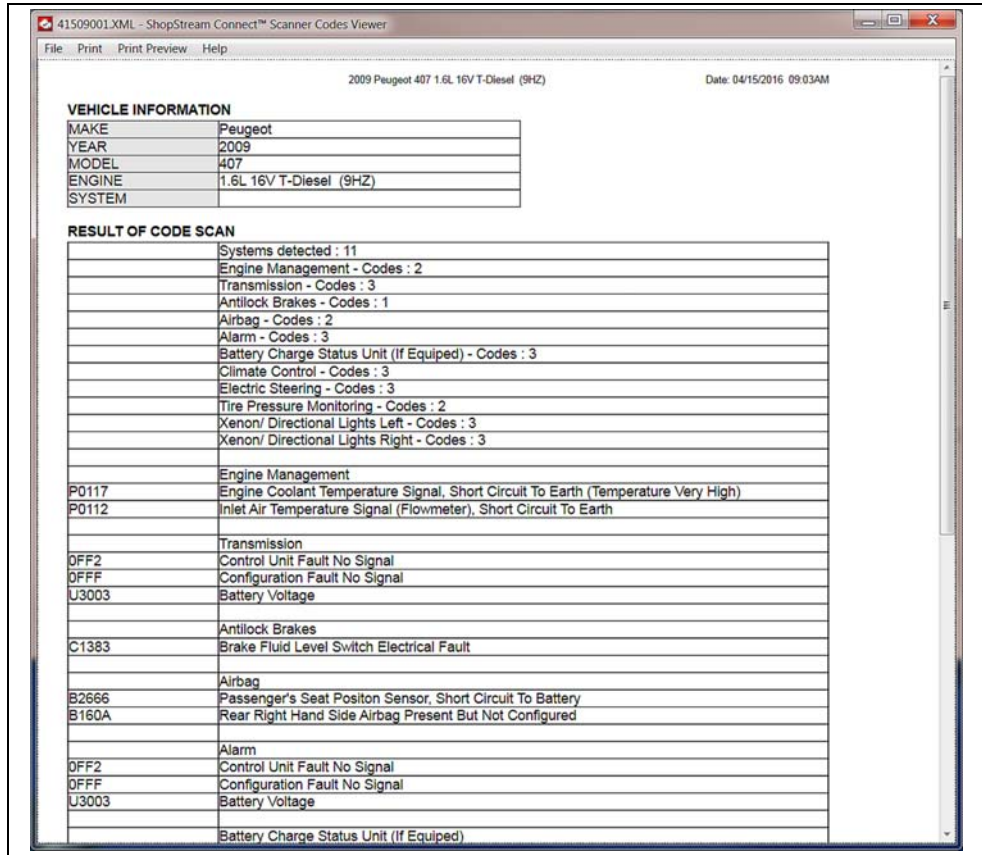



Figure 4-7 Typical Code Scan Report in Shopstream Connect

Depending on the vehicle, Code Scan (if supported) may be available from the Systems menu. Selecting **Code Scan** starts an active scan of vehicle control modules, and opens the Code Scan results screen (Figure 4-8). A progress indicator is shown at the top indicating the active scanning progress. Once completed, the results are displayed by system category.

The following Code Scan related control icons are used:

| Icon | Function |
|---|--|
|  | Refresh - Restarts the code scan |
|  | System - Opens the main menu of the system selected |

The following results are displayed progressively as the modules are scanned:

- **The total number of systems (modules) detected** (Figure 4-8).



Figure 4-8 Code Scan systems analyzed result total

- **A list of all the systems analyzed with DTCs totals.** A categorized system list with DTC totals is displayed in the order they are scanned. To view the main menu for a system in the list, select the system, then select the **System** icon (Figure 4-9).

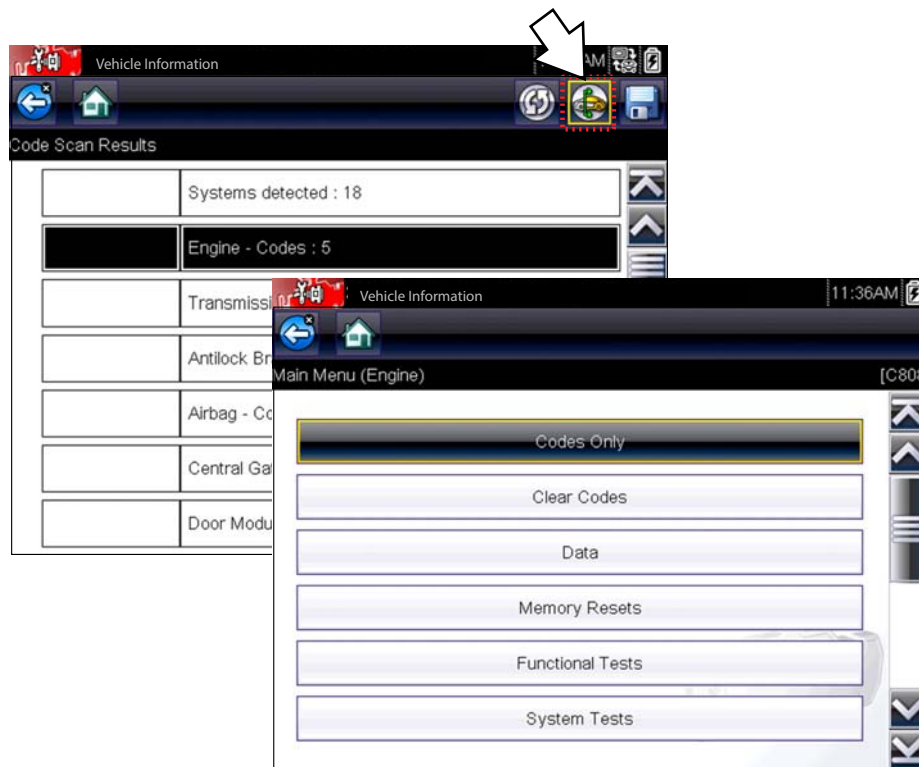

Figure 4-9 System icon (opens Main Menu)



NOTE:

Some 2005 to 2008 vehicles may not display global OBD-II information in the Code Scan list. A message will be displayed to inform you the OBD-II - codes and monitors for this vehicle may be accessed using the global OBD-II function. See [OBD-II/EOBD](#), on page 43.

Saving Codes, and Code Scan Results)

When using the code scan feature, or when viewing individual system codes (e.g. engine, transmission) selecting the **Save** icon from the toolbar saves the results as a data file.

The saved file(s) can be viewed using two methods:

- On the diagnostic tool - See [View Saved Data](#), on page 51.
- Using ShopStream Connect - See [ShopStream Connect](#), on page 70.

Printing the Code Scan Report

The vehicle system report can also be customized and printed using ShopStream Connect - See [Printing the Code Scan Report](#), on page 74.

Clear All Codes Read by Code Scan

Selecting **Clear All Codes Read by Code Scan** erases all DTCs from all vehicle system modules that were read by Code Scan.

**NOTE:**

Clear All Codes Read by Code Scan may not clear global OBD-II codes on some vehicles.

Data Display

Select **Data** to view PID data from the vehicle ECM. In data display mode the screen has a toolbar and a main body (Figure 4-10).

| Engine Data - Engine Speed (RPM) | | 381 / 2000 |
|----------------------------------|-------|------------|
| Engine Speed (RPM) | 1947 | ↑ |
| Desired Idle (RPM) | 550 | ↑ |
| Desired IAC Position | 196 | ⋮ |
| IAC Position | 196 | |
| Coolant (°F) | 199 | |
| Intake Air (°F) | 118 | ↓ |
| MAF (g/s) | 67.25 | ↓ |

Figure 4-10 Data display screen

The toolbar control icons are described in [Scanner Control Icons](#), on page 23 and [Common Toolbar Control Icons](#), on page 18.

During data display the main body of the screen is divided into two columns; the left-hand column has a description of the parameter and the right-hand column shows the parameter value or state. Parameters are listed in the order in which they are transmitted by the ECM, so expect variations between years, makes, and models.

Up to three parameters can be locked, or fixed, at the top of the list. Locked parameters do not change as you scroll through the parameter list. The **Lock/Unlock** icon on the toolbar selects which parameters are fixed (see [Locking Parameters](#), on page 35).

Displayed data may also be paused or saved for detailed review and future reference, see [Saving Files](#), on page 38 and [Pausing and Reviewing Data Files](#), on page 39.

Customizing the Data List

The **Custom Data List** icon on the toolbar is used to determine which specific parameters display. Minimizing the number of parameters on the data list allows you to focus on any suspicious or symptom-specific data parameters. You can add or remove most parameters from the list. Certain vital parameters may not be removed. These appear in gray at the top of the list along with a lock icon, and they cannot be selected.

**NOTE:**

Limiting the number of parameters that display to those that apply to a particular situation results in a faster data refresh rate, and reduces the amount of memory used for saved files.

**To create a custom data list:**

1. Select the **Custom Data List** icon on the toolbar to select it.

The data selection screen displays and two new icons appear on the toolbar. Check marks to the left of the parameter description indicate which parameters are selected for display. A second smaller check box indicates a parameter that is locked.

The toolbar icons provide options for selecting and deselecting parameters to include or remove from the custom data list:

| Icon | Description |
|------|--|
| | Select/Deselect , use to mark individual parameters to hide or display. Any locked parameters cannot be deselected. |
| | Select All/Deselect All , use to hide or display all of the parameters in the list. Any locked parameters cannot be hidden. |

2. Create a custom data list by selecting the parameters to include. A parameter that displays has a check mark alongside the name, a parameter that does not display does not. Select which parameters to display:
 - a. Selecting the **Select All/Deselect All** icon immediately changes all of the parameters to the same condition, a second push changes them all back.
 - b. Selecting the **Select/Deselect** icon activates it. Now you can add or remove parameters by selecting individual entries in the list.

Note the following:

- Items at the top of the list that cannot be highlighted are locked and cannot be turned off.
- Use the **Select All** icon to display the complete list.
- Use the **Deselect All** icon to remove all of the highlights.

3. Select **Back** to display the updated data list.

Changing Screen Views

Selecting the **View** icon opens a drop-down menu of options:

- PID List
- 1 Graph
- 2 Graph
- 4 Graph

The PID (parameter identification) List view is a 2-column display with the name of the parameters in the left column and their current values in the right column (Figure 4-10).

The 1, 2, and 4 Graph views divide the screen horizontally to simultaneously display data graphs for the indicated number of parameters (Figure 4-11). Use the scroll bar or the **up** (▲) and **down** (▼) icons to view other parameters in the list.

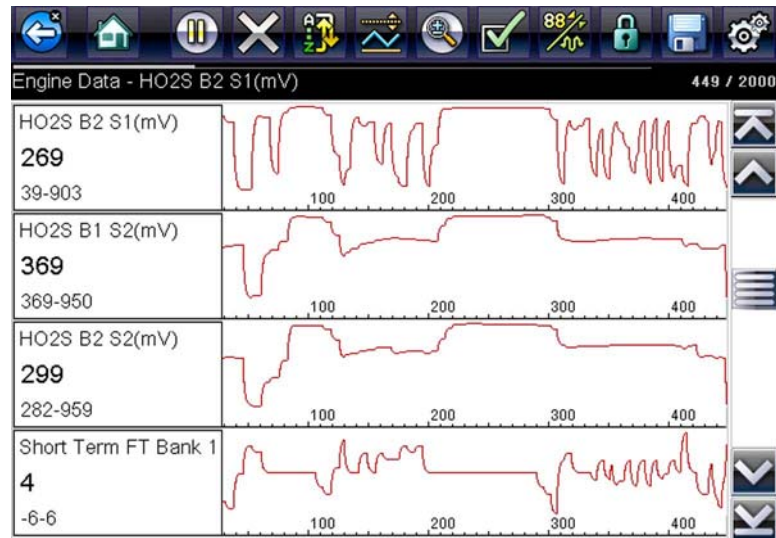

Figure 4-11 Four graph view



NOTE:

Any previously set conditions, such as held data or locked lines of data, remain in effect when the screen view is changed.

Locking Parameters

Use the **Lock/Unlock** icon to hold selected lines of the data in place and prevent them from scrolling, or to release previously locked lines of data. Up to three lines of data may be held at a time. This feature allows you to position related parameters together, making it easier to monitor their values and spot inconsistencies.

Locked parameters display as the top frames on the main body of the display screen, as well as at their usual position within the data list (Figure 4-12). A lock icon appears to the left of the parameter name to indicate it is locked.



To lock parameters:

1. Highlight the parameter to be locked.
2. Select the **Lock/Unlock** icon on the toolbar to lock it.

A copy of the locked parameter is now shown at the top of the data list, and a lock icon appears alongside the parameter name.

3. Highlight and select additional parameters to lock.

Up to three parameters can be locked at a time. Once locked, a parameter remains locked until it is manually unlocked or communication with the vehicle stopped.

| Engine Data - Long Term FT Bank 2 (%) | | 1465 / 2000 |
|---------------------------------------|--------------------------|-------------|
| | HO2S B1 S1(mV) | 503 |
| | HO2S B1 S2(mV) | 786 |
| | Short Term FT Bank 1 (%) | -1 |
| | Short Term FT Bank 2 (%) | 0 |
| | Long Term FT Bank 1 (%) | 12 |
| | Long Term FT Bank 2 (%) | 11 |
| | Fuel Trim Learn | Enabled |

Figure 4-12 Locked parameters



NOTE:

If three parameters are locked, one of them must first be unlocked before another parameter can be locked.



To unlock parameters:

1. Scroll through the data list and highlight the parameter to be unlocked, or released.
2. Select the **Lock/Unlock** icon on the toolbar.

The released parameter and the lock icon disappear from the list at the top of the data list.

3. Repeat Step 1 and Step 2 to release other parameters if needed.

Setting Trigger Levels

The trigger icon allows you to configure the Diagnostic Tool to automatically save PID data from buffer memory to a file when a parameter value crosses a threshold. When triggering is armed, a "Trigger event" pauses data collection and saves data to a file.

Selecting the **Trigger** icon opens a menu that includes:

- **Set Trigger**—establishes upper and lower signal values to initiate an event capture for the highlighted parameter.
- **Arm Trigger**—activates the Diagnostic Tool to capture an event when the signal crosses a threshold value.
Trigger lines change colors to indicate the trigger is armed.
- **Clear All Triggers**—deletes all previously set trigger levels.

If triggers are set the menu options are:

- **Clear Trigger**—deletes set trigger levels for the highlighted parameter.
- **Disarm Trigger**—de-activates event capture capability.
- **Clear All Triggers**—deletes all previously set trigger levels.



To set trigger levels:

1. Highlight the parameter to be used for triggering the recording.
2. Select the **Trigger** icon.
3. Select **Set Trigger** from the drop-down menu.

A graph of the highlighted parameter with a trigger toolbar above it fills the main body of the screen (Figure 4-13).

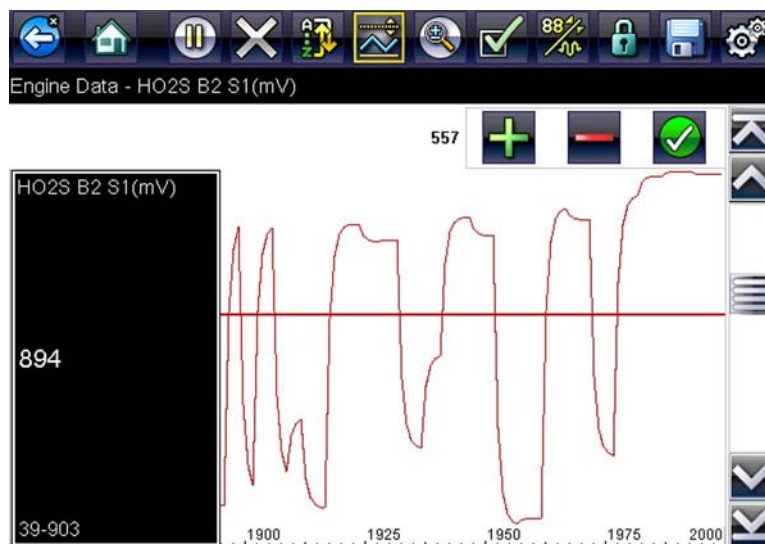

Figure 4-13 Trigger set screen

The trigger level line displays as a solid line running horizontally across the data graph. An upper and lower trigger level must be set, the upper level is set first.

4. Select the plus (+) and minus (-) icons on the toolbar, or use the up ▲ and down ▼ arrow buttons to position the upper trigger level to where you want it on the graph.
5. Select ✓ on the toolbar, or press the Y/✓ button, to set the upper threshold.

A lower trigger level line now appears at the mid-point of the graph.

6. Select the plus (+) and minus (–) icons on the toolbar, or use the up ▲ and down ▼ arrow buttons to position the lower trigger level line to where you want it on the graph.
7. Select ✓ on the toolbar, or press the **Y/✓** button, to set the lower threshold.

The display returns to the PID data view and the trigger points appear as horizontal lines across the designated parameter graph. Repeat this procedure to establish trigger points for other parameters if desired. Once armed, any data points that register outside of your set conditions pause data collection and save data to a file.



NOTE:

Only three parameters can have trigger levels set at one time, but only one of the conditions needs to be satisfied for triggering to occur.



To arm triggers:

1. Select the **Trigger** icon on the toolbar.
2. Select **Arm Triggers** from the drop-down menu.

The trigger lines on the data graphs change color to indicate an armed condition.

Triggers for all of the graphs are armed simultaneously. Once triggering is armed, it remains in that state until you switch it off. If trigger settings are modified or are added for other parameters, they are armed as soon as you exit the setting screen.

Saving and Reviewing Scanner / OBD-II/EOBD Data Files

The following procedures are used when saving and reviewing data files for Scanner and OBD-II/EOBD.

Saving Files

During normal operation, data from the vehicle's ECM is continuously being stored in buffer memory as it is displayed onscreen. Buffer memory is limited to a predetermined "total" size and is displayed on the counter (located below the toolbar on the right side of the screen) ([Figure 4-15](#)).

Selecting **Save** writes the stored buffer memory to a file. Saving data is useful when trying to isolate an intermittent problem or to verify a repair during a road test. The saved file can be played back (similar to a movie clip) by selecting **Previous Vehicles and Data > View Saved Data**. See [View Saved Data](#), on page 51 for additional information.



NOTE:

The **Save icon** performs the same function as "Save Movie" function choice for the programmable **Shortcut** button, see [Configure Shortcut Button](#), on page 55 for details.

The saved data file can also be downloaded to a personal computer (PC) using the Mini USB jack. Once connected to the PC, the data files can be printed, transferred, and copied using ShopStream Connect. ShopStream Connect is an application that creates an interface between the Diagnostic Tool and a PC. The ShopStream Connect application is available free online, see the ShopStream Connect website information at the front of this manual for additional information.

The toolbar control icons are described in [Scanner Control Icons](#), on page 23 and [Common Toolbar Control Icons](#), on page 18.

**To save data:**

- Select **Save**.

A save dialog box displays while data is being saved. The data is saved when the message box disappears.

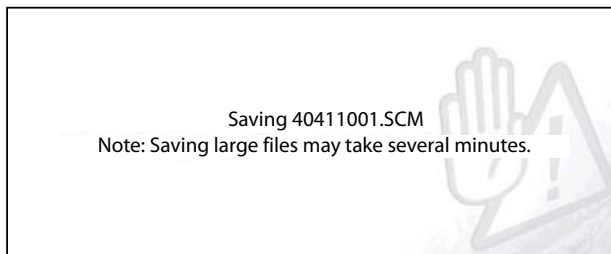

Figure 4-14 Save dialog box

Saving Screens

The **Shortcut** button can be programmed to save a snapshot of a visible screen as a bitmap file, see [Configure Shortcut Button](#), on page 55 for details. The saved file can be viewed by selecting **Previous Vehicles and Data > View Saved Data.**, see [View Saved Data](#), on page 51 for additional information.

Pausing and Reviewing Data Files

During normal operation, data from the vehicle's ECM is continuously being stored in buffer memory as it is displayed onscreen. The Pause feature, allows you to temporarily pause data collection to review it in detail.

**To pause and review data**

Toolbar control icons are described in [Scanner Control Icons](#), on page 23 and [Common Toolbar Control Icons](#), on page 18.

1. While viewing data, select the **Pause** icon.

On the toolbar, the playback control icons are displayed. A counter displays along the right-hand edge of the screen between the toolbar and the main body. A bar graph to the left of the counter shows how much data is in the memory buffer. A slider on the bar graph indicates the position of the current screen in relation to the entire contents of the data buffer.

Use the slider to quickly scroll through the data. Use the control icons to accurately position the cursor. The cursor (vertical line), indicates your position when in the graph mode, appears once you begin navigating ([Figure 4-15](#)).

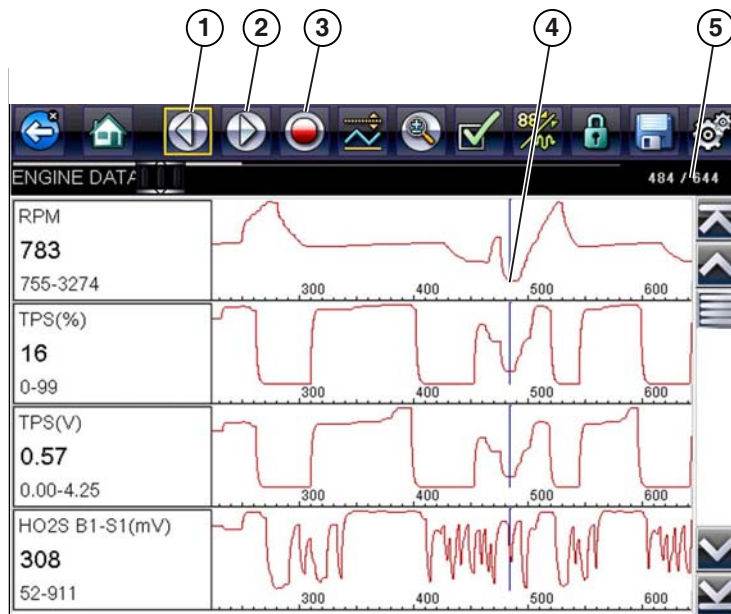

- | | |
|-----------------|---------------------------------------|
| 1— Step Back | 4— Cursor |
| 2— Step Forward | 5— Counter (current position / total) |
| 3— Record | |

Figure 4-15

2. Scroll up or down to review the list of data.
3. Select the desired control icon to move forward or back incrementally in the selected direction.

**To resume:**

- Select the **Record** icon.
The display changes back to display data and the **Pause** icon is shown on the toolbar. A vertical rule runs through the data graph to indicate data was paused at that point.

**NOTE:**

The **Shortcut** icon can be set to perform the Pause/Play function. See [Configure Shortcut Button](#), on page 55 for additional information.

Generic Functions

Generic Functions are use to perform generic OBD-II/EODB tests, for additional information see [OBD-II/EODB](#), on page 43.

Functional Tests

The **Functional Tests** selection is used to access vehicle-specific subsystem tests. Available tests vary by manufacturer, year, and model. Only the tests available for the identified vehicle display in the menu.

There are several types of functional tests:

- **Information Tests**—these are read-only tests, like selecting “VIN” from a Functional Tests menu to display the VIN of the identified vehicle.
- **Toggle Tests**—these tests switch a component, such as a solenoid, relay, or switch, between two operating states.
- **Variable Control Tests**—these tests command a certain value for a system or component, such as varying spark timing in 1° increments or EGR valve duty cycle in 10% increments.
- **Reset Tests**—these tests reset the adaptive, or learned, values that are stored in the vehicle electronic control module memory.
- **Scripted Tests**—these tests are software routines that place the vehicle into special operating modes for performing certain repairs, such as bleeding brakes with ABS.

Selecting Functional Tests opens a menu of test options that varies by make and model. Selecting a menu option either activates the test or opens a submenu of additional choices. Follow all screen instructions while performing tests. How and what information is presented on the screen varies according to the type of test being performed and the vehicle being serviced.

Toggle and variable control tests often display functional test controls on the toolbar at the top of the screen with PID data in the main body (Figure 4-16).

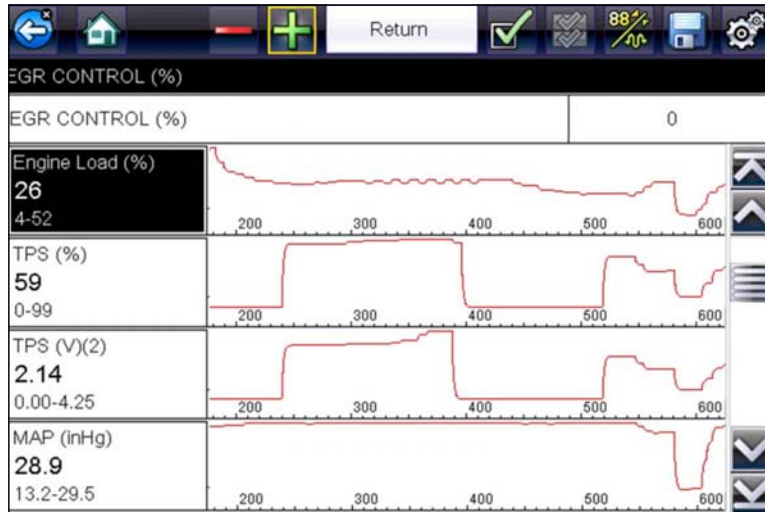

Figure 4-16 Functional test screen

A Test icon on the toolbar activates the test, and a Return, or similarly named, icon cancels the test. For variable control tests, the variable value displays between the main body and the toolbar. Plus and Minus icons on the toolbar increase and decrease the variable value.



A Data List icon, shown to the left, is available on the toolbar for some tests. This feature allows you to change which data list displays in the main body without exiting the functional test. The icon is only available when the test is inactive.

4.4 Exiting Scanner

Scanner function remains open as long as there is an active communication link with the vehicle. You must interrupt this communication link in order to exit from tests and power down the Diagnostic Tool. A warning message displays if you attempt to shut down while the Diagnostic Tool is communicating with the vehicle.

**NOTE:**

Damage to the vehicle electronic control module (ECM) may occur if communication is disrupted. Make sure the data cable is properly connected at all times during testing. Exit all tests before disconnecting the data cable or powering down the Diagnostic Tool.

**To exit the Scanner function:**

1. From any active data screen, select the **Back** icon on the toolbar.
A “stopping communications” message briefly displays followed by the Data menu.
2. From the Data Menu, select **Back** on the toolbar.
Again, a “stopping communications” message briefly displays followed by the Main menu.

Now, the Diagnostic Tool is no longer communicating with the vehicle and it is safe to return to the Home screen and power down the Diagnostic Tool.

This chapter describes the basic operation of the OBD-II/EOBD function.



The **OBD-II/EOBD** icon is located on the Home screen.

The OBD-II/EOBD function allows you to access “generic” OBD-II/EOBD data. Generic OBD-II/EOBD data is data limited to emission related diagnostics such as:

- Checking for emissions-related diagnostic trouble codes (DTCs)
- Checking the cause of an illuminated malfunction indicator lamp (MIL)
- Checking monitor status prior to emissions certification testing

To access other available electronic control module (ECM) data for vehicle specific systems, parameters or enhanced diagnostics use the Scanner function, see “[Scanner](#)” on [page 22](#).



NOTE:

The OBD-II/EOBD function can also be used to access “generic” OBD-II/EOBD data for OBD-II/EOBD compliant vehicles that are not included in the Scanner function databases.

5.1 Basic Operations

5.1.1 Screen Layout and Toolbar Controls

Screen layout and toolbar controls are similar to the Scanner function, see [Screen Layout and Toolbar Icons](#), on [page 22](#),.

5.1.2 Connecting the Data Cable

Connection of the data cable to the Diagnostic Tool and vehicle DLC is required for OBD-II/EOBD testing, see [Data Cable Connection](#), on [page 21](#),.

5.1.3 Saving and Reviewing Data Files

Save and Pause control icon operation and data review procedures are the same as used for the Scanner function, see [Saving and Reviewing Scanner / OBD-II/EOBD Data Files](#), on [page 38](#),.

5.2 OBD-II/EOBD Menu

5.2.1 OBD Direct

OBD Direct includes the following menu and submenu choices:

- **OBD Diagnose**
 - **Start Communication** - initiates a test session
 - **Connector Information** - provides DLC location details
 - **Manual Protocol Selection** - provides choices for communication protocol
- **OBD Training Mode** - allows you to familiarize yourself with the capabilities of OBD-II/EOBD while navigating through menus without being connected to a vehicle.

Start Communication

Use the following procedure to begin an OBD-II/EOBD test session:



To perform an OBD-II/EOBD Test:

1. Connect the data cable to the test vehicle.
2. Select **Start Communications** from the OBD-II/EOBD menu.

A series of messages are displayed indicating automatic detection of vehicle type (12 or 24 V) has occurred and then the detected controllers are displayed.

The Diagnostic Tool establishes a communication link with the test vehicle, then opens an information screen (Figure 5-1).

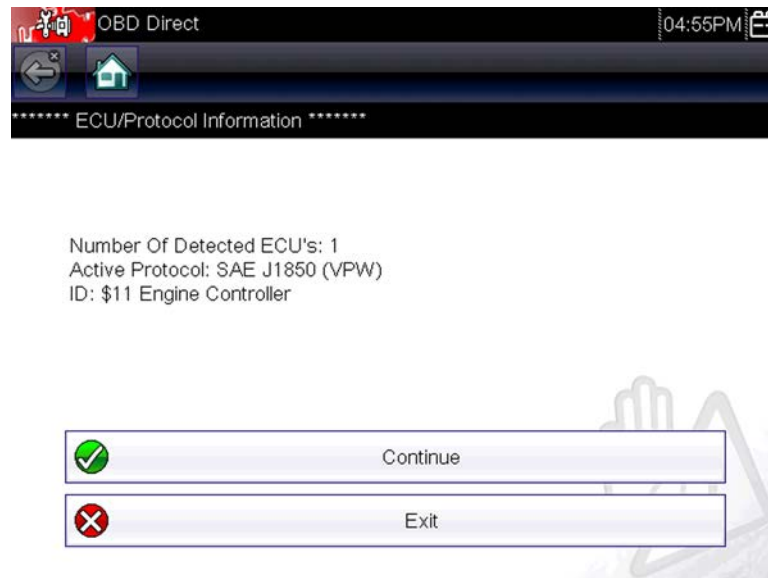

Figure 5-1 Protocol information

The information screen shows how many control modules were detected, which ECM is communicating, and which communication protocol is being used.

3. Select **Continue**.

A Select Service menu of available tests opens:

- [Readiness Monitors](#), on page 45,
- [MIL Status](#), on page 45,
- [\(\\$01\) Display Current Data](#), on page 46,
- [\(\\$02\) Display Freeze Frame Data](#), on page 46,
- [\(\\$03\) Display Trouble Codes](#), on page 46,
- [\(\\$04\) Clear Emissions Related Data](#), on page 46,
- [\(\\$05, 06, 07\) Display Test param./Results](#), on page 47,
- [\(\\$08\) Request Control of On-board System](#), on page 48,
- [\(\\$09\) Read Vehicle Identification](#), on page 48,
- [\(\\$09\) In-use Performance Tracking](#), on page 48,
- [\(\\$0A\) Emission Related DTC with Permanent Status](#), on page 48,

IMPORTANT:

All service modes are not supported by all vehicles, so the available menu selections will vary.

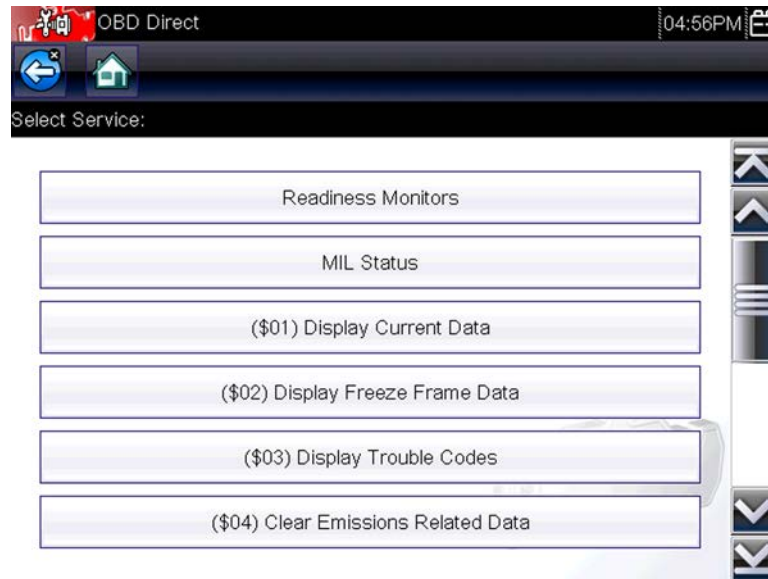

Figure 5-2 Service mode menu

4. Select a test to continue.

Readiness Monitors

Use this menu item to check the readiness of the monitoring system. Monitors not supported will display “not supported”. Scroll, if needed, to view the entire list of monitors (Figure 5-2). Selecting Readiness Monitors opens a submenu with two choices:

- **Monitors Complete Since DTC Cleared**—displays the results of all monitor tests that have run since the last time the vehicle electronic control module (ECM) memory was cleared.
- **Monitors Complete This Cycle**—displays only the results of monitor tests that ran during the current drive cycle, they reset when the ignition is switched off.

MIL Status

This item is used to check the current condition of the malfunction indicator lamp (MIL). Additional information, such as which ECM commanded the MIL on and the distance driven while the MIL is on (if supported), can also be displayed. The MIL Status report can also be saved as part of the vehicle records.

(\$01) Display Current Data

Use this test to display the serial data transmitted by the selected vehicle electronic control module (ECM). The main body of the screen has two columns; the left-hand column is a description of the parameter and the right-hand column is the parameter value or state. Viewing options and operations are the same as the Scanner function, see [Data Display](#), on page 33, for more information.

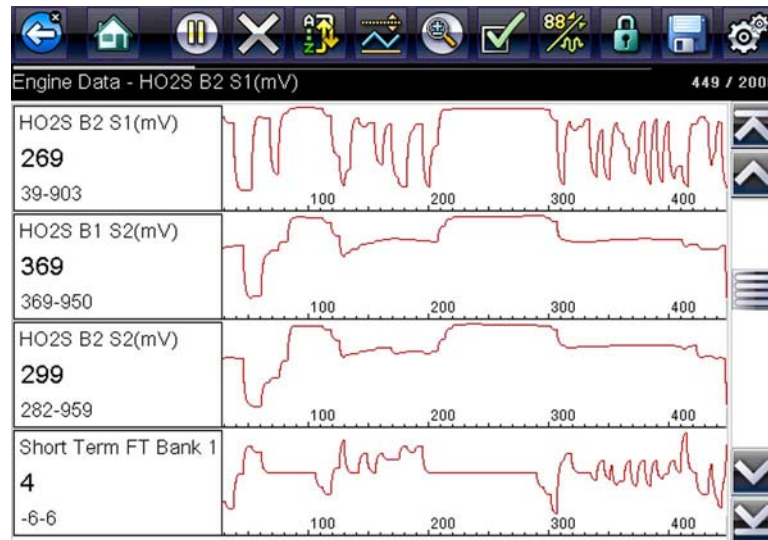

Figure 5-3 Current data display

(\$02) Display Freeze Frame Data

Freeze frame data provides a “snapshot” of critical parameter values at the time a DTC set.

This item is used to display freeze frame data for any stored emission related diagnostic trouble codes (DTCs). In most cases the stored frame is the last DTC that occurred. Certain DTCs, those that have a greater impact on vehicle emissions, have a higher priority. In these cases, the highest priority DTC is the one for which the freeze frame records are retained.

(\$03) Display Trouble Codes

This is used to display any stored emission related DTCs reported by the ECM. The display is similar to the Scanner function code display (see [Display Codes](#), on page 28, for details). The list does not include enhanced DTCs in this mode.

(\$04) Clear Emissions Related Data

This item is used to clear all emission related diagnostic data, such as DTCs, freeze frame data, and test results, from the memory of the selected ECM.



To clear emission related Data:

1. Select **Clear Emissions Related Data** from the menu.
A confirmation message displays to help prevent loss of any vital data (Figure 5-4).

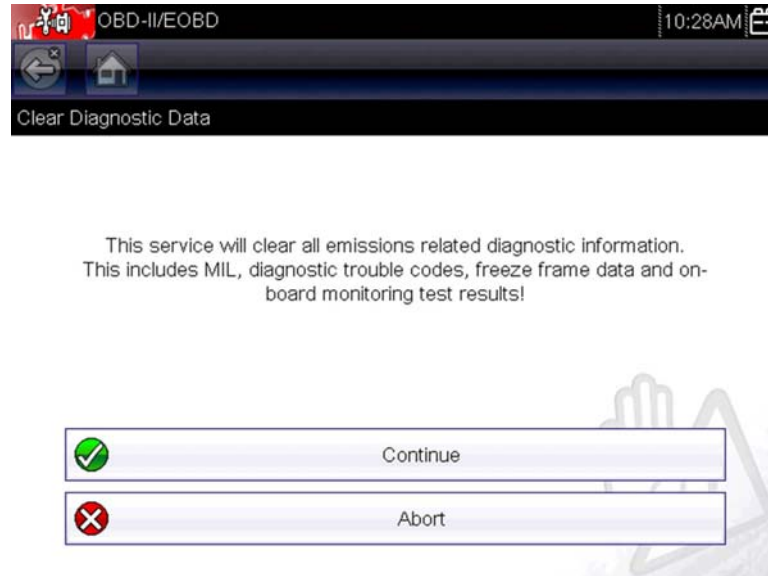

Figure 5-4 Clear codes confirmation message

2. Continue from the confirmation message.
The screen updates several times as ECM memory is erased, then a “data has been cleared” message displays.
3. Select **Continue** to return to the Select Service menu.

(\$05, 06, 07) Display Test param./Results

This option opens a submenu of parameters and test results from various sensors, monitor test results, and a record of DTC setting conditions detected during the last drive cycle. The submenu includes:

- [\(\\$05\) Oxygen Sensor Monitoring](#)
- [\(\\$06\) On-board Monitored Systems](#)
- [\(\\$07\) DTCs Detected During Last Drive](#)

(\$05) Oxygen Sensor Monitoring

This option opens a menu of tests available for checking the integrity of the oxygen (O₂) sensors. Making a selection displays all of the pertinent O₂ sensor parameters for the specific test. The test identification (ID) displays at the top of the data list.

(\$06) On-board Monitored Systems

This option opens a menu of tests from the monitored systems. The available data is for specific systems and components that the on-board diagnostic system monitors continuously, such as misfire, or non-continuously, such as the catalyst system. Making a menu selection displays the test results.

(\$07) DTCs Detected During Last Drive

This test opens a record of any DTCs that set during the last completed drive cycle. Select to open the DTC list.

(\$08) Request Control of On-board System

This service enables bidirectional control of the ECM. This service allows the Diagnostic Tool to control the operation of an on-board system, test, or component.

(\$09) Read Vehicle Identification

The purpose of this service is to enable the Diagnostic Tool to request and display vehicle-specific information, such as the vehicle identification number (VIN), the calibration identification, and the calibration verification number (CVN), of the test vehicle. Select a menu item to retrieve the information. Select **Return** to go back to the menu.

(\$09) In-use Performance Tracking

This option displays the “In-use Performance Tracking” of data. It is a record of the number of times each of the monitor tests have been completed. Select **Return** to go back to the menu.

(\$0A) Emission Related DTC with Permanent Status

This option displays a record of any “permanent” codes. A permanent status DTC is one that was severe enough to illuminate the MIL at some point, but the MIL may not be on at the present time.

Whether the MIL was switched off by clearing codes or because the setting conditions did not repeat after a specified number of drive cycles, a record of the DTC is retained by the ECM. Permanent status codes automatically clear after repairs have been made and the related system monitor runs successfully.

Connector Information

This option opens a database of vehicle diagnostic connector locations that includes most makes and models. The menu driven interface leads you quickly to difficult to find test connectors.

**To locate a vehicle diagnostic connector:**

1. Select **Connector Information** from the System menu.
A list of vehicle manufacturers displays.
2. Select a manufacturer from the list.
A list of models available from the selected manufacturer displays.
3. Select a model from the list.
If a cable adapter is needed, which one and how to connect it displays.
4. Select **Continue**.
Information on where to locate the vehicle diagnostic connector displays.
5. Select **Continue** to return to the System menu.

Manual Protocol Selection

Communication protocol is a standardized way of transferring data between an ECM and a Diagnostic Tool. Global OBD may use the following communication protocols:

- ISO 15765-4 (CAN)
- ISO 27145 (WWHOBD CAN)
- ISO J1939 (CAN)
- ISO 9141-2 (K-LINE)
- SAE J1850 PWM (Pulse Width Modulation)
- SAE J1850 VPW (Variable Pulse Width)
- ISO 14230-4 (Keyword Protocol 2000)
- SAE J2284/ISO 15765-4 (CAN)

When initially attempting to establish communication with the ECM the Diagnostic Tool attempts to communicate trying each protocol in order to determine which one is being used. During normal operation the communication protocol is automatically detected. If automatic detection fails, communication protocol can be manually selected.

IMPORTANT:

Using unsupported OBD communication protocols may activate warning lights and can set network related faults. Only use the manual selection option when OBD protocol is already known.

Select **Manual Protocol Selection** to open a menu of options (Figure 5-5).

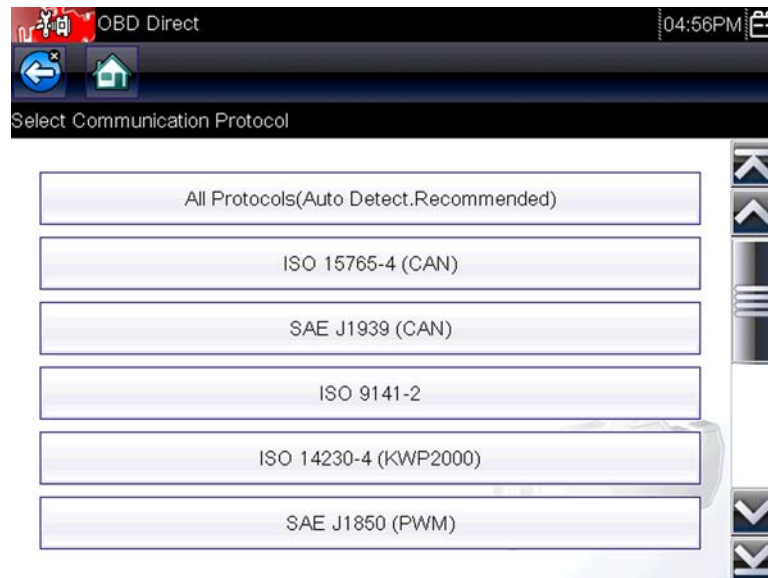

Figure 5-5 Manual protocol selection menu

Select the **Back** icon or press the **N/X** button to return to the OBD-II/EOBD Main menu.

This chapter describes the basic operation of the Previous Vehicles and Data function.



The **Previous Vehicles and Data** icon is located on the Home screen. This function allows you to select recently tested vehicles and access saved data files.

6.1 Previous Vehicles and Data Menu

The following options are available from the Previous Vehicles and Data menu:

- [Vehicle History](#)
- [View Saved Data](#), on page 51,
- [Delete Saved Data](#), on page 53,

6.1.1 Vehicle History

The Diagnostic Tool stores the identification of the last twenty-five vehicles tested, so there is no need to go through the complete vehicle identification sequence when performing a retest after repairs have been made. The oldest vehicle record is deleted when a new vehicle is identified once there are twenty-five vehicles on file.

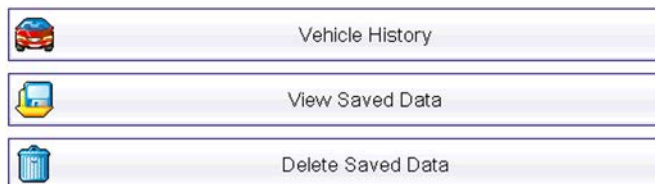

Figure 6-1 Vehicle history list



To select from the vehicle History:

1. Select **Previous Vehicles and Data** from the Home screen.
2. Select **Vehicle History** from the menu.
A list of up to 25 previously tested vehicles displays. Each vehicle is given a unique file name. Scroll to view the entire list.
3. With the item to be opened highlighted, either select the vehicle ID or press the **Y/✓** button.
The appropriate software loads and a vehicle ID confirmation screen displays.
4. Select **OK** or press the **Y/✓** button to continue.
The System Menu for the selected vehicle displays.

6.1.2 View Saved Data

Selecting the **View Saved Data** menu option opens a list of all the saved data (movie) files and screen images that are stored in memory. Saved files are listed in chronological order by the date and time that they were created with the most recent files are at the top of the list.



Figure 6-2 Saved data list

Saved files can either be opened directly on the Diagnostic Tool, or downloaded to a personal computer and opened using [ShopStream Connect](#). See [Pausing and Reviewing Data Files](#), on page 39, and [Connect-to-PC](#), on page 55, for additional information.



NOTE:

A maximum of 50 files are displayed. To view all (if more than 50) files stored, use [ShopStream Connect](#). See [Connect-to-PC](#), on page 55, for additional information.



To review a saved data file or image:

1. Select **Previous Vehicles and Data** from the Home screen.
2. Select **View Saved Data** from the menu.
3. Select a file to review from the list.

6.1.3 Viewing Codes and Code Scan Results

When code scan or single system code results are saved, they are saved in (.XML) file format (Figure 6-3).



Figure 6-3 Typical - Code Results (.XML) file

The saved (.XML) file(s) can be viewed using these methods:

- On the diagnostic tool - See [Viewing Code Results on the Diagnostic Tool](#), on page 52,.
- In report format using:
 - ShopStream Connect - see [Printing the Code Scan Report](#), on page 74,.

Viewing Code Results on the Diagnostic Tool

Selecting a system code or a code scan results file from your saved file list (Figure 6-4), opens the file onscreen. When opened, the (.XML) file displays basic vehicle information and a list of DTCs with a brief description of each.

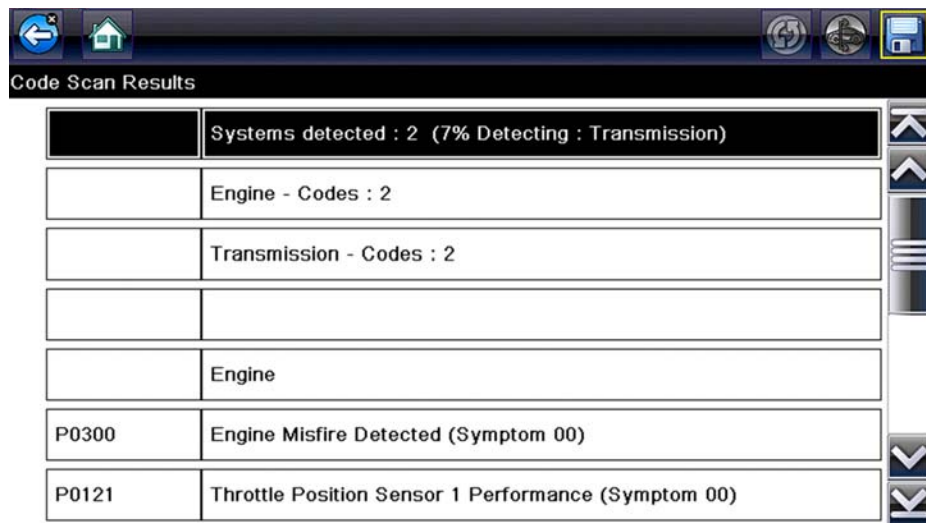

Figure 6-4 Typical - Code Scan Results (.XML file) viewed onscreen

6.1.4 Delete Saved Data

This menu option is used to permanently erase saved files from memory.



To delete a saved file:

1. Select **Previous Vehicles and Data** from the Home screen.
2. Select **Delete Saved Data** from the menu.

A list of saved files displays.



NOTE:

The Select All/Deselect All and Delete icons become available on the toolbar so that you can either delete individual files or clear the entire memory buffer all at once.

3. Select a file from the list and a confirmation message displays.
4. Select an option from the confirmation message:
 - **OK**—deletes the selected file and returns to the saved files list, which no longer includes the deleted file.
 - **Cancel**—returns to the saved files list without deleting the selected file.
5. Select **Back** on the toolbar to return to the Previous Vehicles and Data menu, select **Home** to return to the Home screen.

This chapter describes the basic operation of the Tools function.



The **Tools** icon is located on the Home screen. This function allows you to configure Diagnostic Tool settings to your preferences.

7.1 Tools Menu

The following options are available from the Tools menu:

- [Connect-to-PC](#)—use to transfer and share files with a personal computer (PC).
- [Configure Shortcut Button](#), on page 55,—use to change the function of the shortcut button.
- [System Information](#), on page 57,—use to view configuration information for the Diagnostic Tool.
- [Settings](#), on page 57,—use to configure certain characteristics of the Diagnostic Tool.



Figure 7-1 Tools menu

7.1.1 Connect-to-PC

Connect-to-PC allows you to transfer saved data files on your Diagnostic Tool to your personal computer using a USB cable.

The optional ShopStream Connect™ PC software allows you to view, print and save data files on your PC. In addition, you can download software updates from the PC to the Diagnostic Tool. These features provide an ideal way to manage saved data files. The ShopStream Connect application is available free online, see [ShopStream Connect](#), on page 70, for additional information.



To connect the diagnostic tool to a PC:

1. Connect the supplied USB cable to the diagnostic tool and then to the PC.
A USB cable, supplied with your diagnostic tool, is used to connect the diagnostic tool to the PC. When the diagnostic tool is connected to the PC a communications icon appears on the right edge of the title bar.
2. Select **Tools** from the Home screen.
3. Select **Connect-to-PC** from the Tools and Setup menu.

A screen message will display to confirm the tool is in Connect-to-PC-mode.

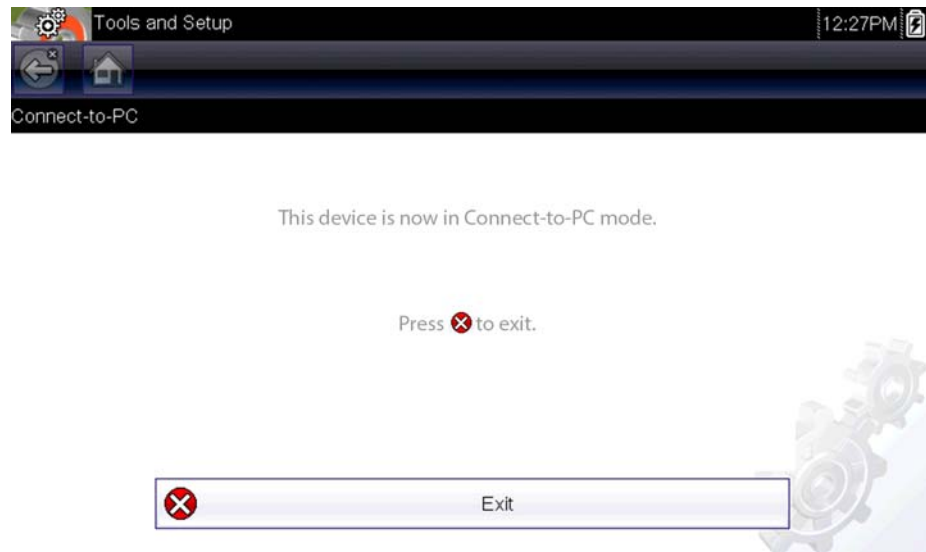

Figure 7-2

7.1.2 Configure Shortcut Button

This feature allows you to change the function of the **Shortcut** button. Options are:

- **Brightness**—opens the brightness setting screen.
- **Save Screen**—saves a bitmap image of the visible screen.
- **Save Movie**—writes PID data from buffer memory to a file for future playback.
- **Show Shortcut Menu**—opens the menu so you can quickly select from any of the functions.
- **Toggle Record/Pause**—programs the Shortcut button to work as the Pause and Play icons.

**To assign a function to the Shortcut button:**

1. Select **Tools** from the Home screen.
The Tools menu opens.
2. Select **Configure Shortcut button** from the menu.
3. Select a function from the menu.
4. Select the **Back** on the toolbar or press the **N/X** button to return to the options menu.

7.1.3 System Information

System Information displays important information such as:

- Patent information
- Software version numbers
- Diagnostic Tool serial number
- Software upgrade program expiration date

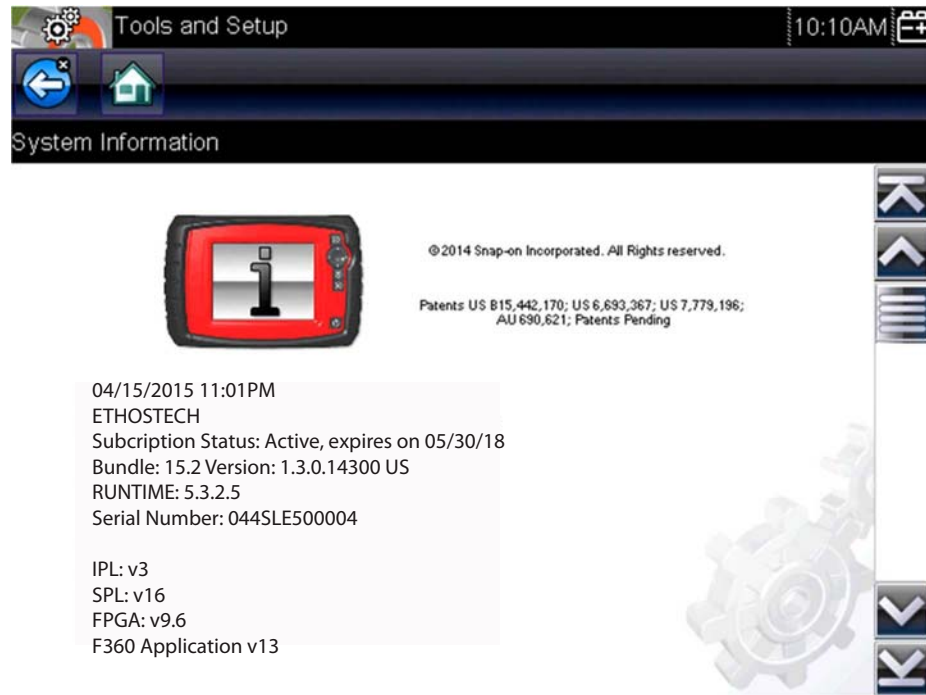

Figure 7-3 System information



To display the System information screen:

1. Select **Tools** from the Home screen to open the menu.
2. Select **System Information** from the menu.
The System Information screen displays.
3. Scroll as needed to view all of the data.
4. Select **Back** on the toolbar or press the **N/X** button to return to the options menu.

7.1.4 Settings

This Tools selection allows you to adjust certain basic Diagnostic Tool functions to your personal preferences. Selecting opens an additional menu that offers the following:

- System Settings - see [System Settings](#), on page 58,
- Configure Scanner - see [Configuring Scanner](#), on page 65,
- Configure Units - see [Configure Units](#), on page 66,

System Settings

Selecting System Settings opens a menu with two options; Display and Date & Time. Either selection opens an additional menu.

Display options include:

- [Brightness](#), on page 59,—adjusts the intensity of the screen back lighting.
- [Color Theme](#), on page 60,—changes the background color of the screen display.
- [High Contrast Toolbar](#), on page 60,—enhances toolbar graphics for poor lighting conditions.
- [Font Type](#), on page 61,—switches between standard and bold text for better visibility.
- [Backlight Time](#), on page 61,—adjusts how long the screen stays on with an idle Diagnostic Tool.
- [Touch Screen Calibration](#), on page 62,—calibrates the touch screen display.

Date & Time options include:

- [Time Zone](#), on page 63,—sets the internal clock to the local time standard.
- [Clock Settings](#), on page 63,—sets the time on the internal clock.
- [Daylight Savings Time](#), on page 64,—configures the clock for Daylight Savings Time.
- [Time Format](#), on page 64,—switches the time displays between a 12 or 24 hour clock.
- [Date Format](#), on page 64,—configures how the month, date, and year displays.

Battery Type

This selection allows you to configure the tool to operate on either standard or rechargeable batteries ([Figure 7-4](#)). The rechargeable setting is designed to maximize battery life. An on-screen message displays in the rechargeable mode when the batteries are in need of a charge.

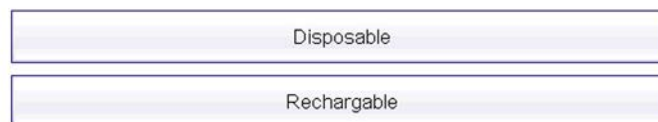

Figure 7-4 Sample battery type screen

Brightness

Selecting this option opens the brightness setting screen for adjusting the back lighting of the display (Figure 7-5).

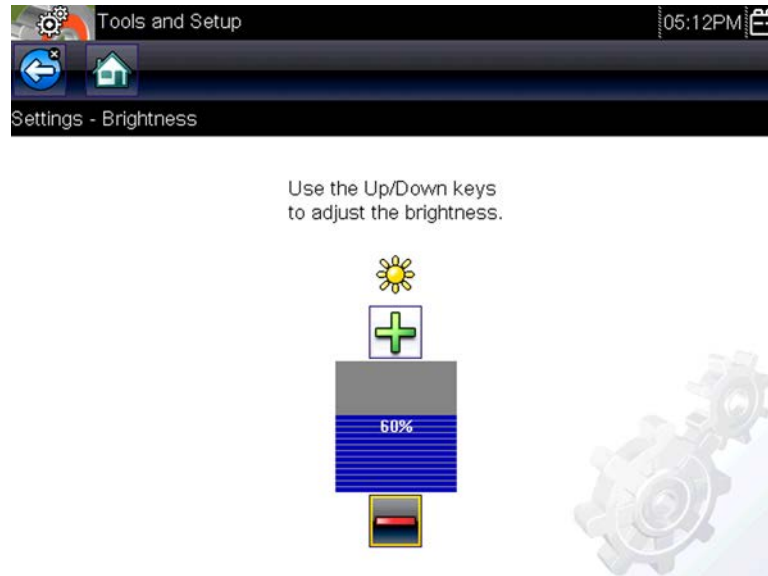

Figure 7-5 Brightness setting

Each push of the **Plus** and **Minus** icons, or the up (▲) and down (▼) arrows, incrementally changes the back lighting up or down respectively.

Select **Back** from the toolbar or press the **N/X** button to exit.

Color Theme

This option allows you to select between a white and black background for the screen. The black background can be beneficial when working under poor lighting conditions.

Selecting opens a menu with two choices: **Day Theme** (white background) and **Night Theme** (black background). Make a selection and a “please wait” message momentarily displays followed by the Home screen. The new toolbar setting is now active.

High Contrast Toolbar

This option allows you to switch to a high contrast toolbar. This toolbar features black and white icons with crisp graphics that are easier to see in poor lighting conditions or bright sunlight.

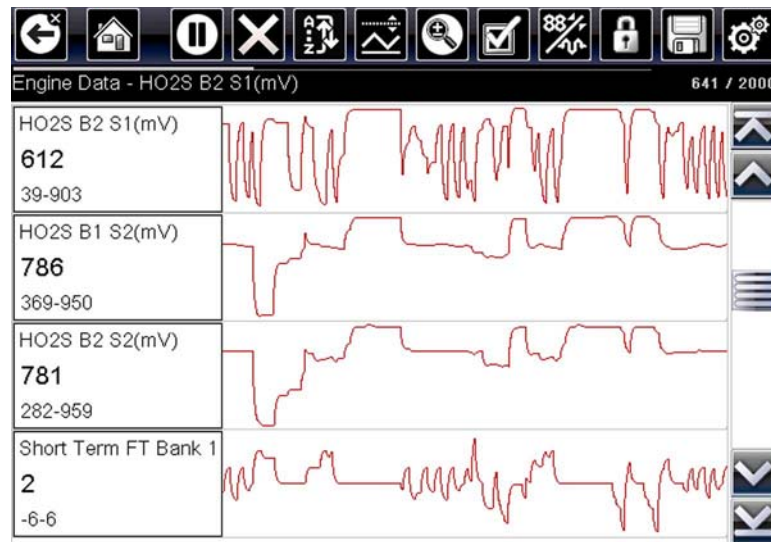
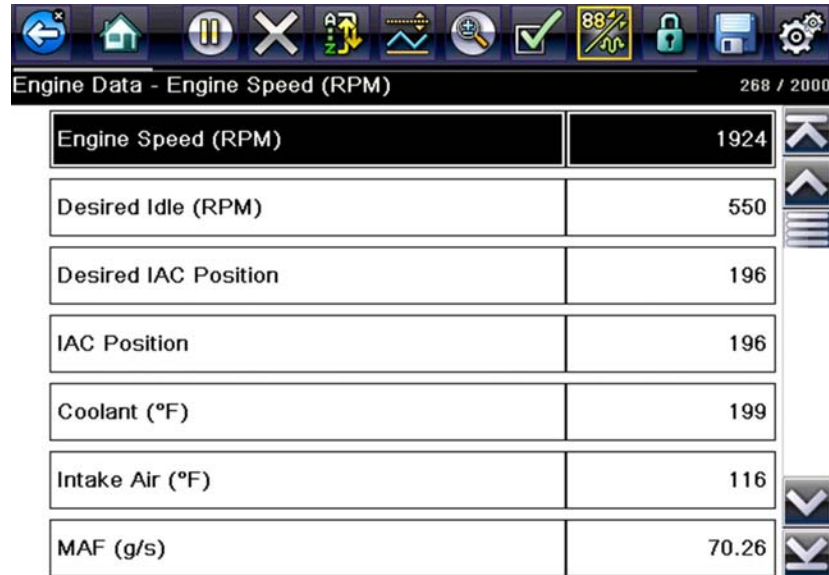

Figure 7-6 High-contrast toolbar

Selecting opens a menu with two choices; **Color Toolbar** and **High Contrast Toolbar**. Select and a “please wait” message displays followed by the Home screen. The new setting is now active.

Font Type

This option allows you to select between standard and bold faced type for the display screen. Bold type makes screen writing more legible under poor lighting or bright sunlight conditions.



The screenshot shows a diagnostic tool interface with a toolbar at the top containing icons for back, home, pause, close, and other functions. Below the toolbar, the screen title is "Engine Data - Engine Speed (RPM)" with a battery level indicator of "268 / 2000". The main display area shows a table of engine parameters:

| | |
|----------------------|-------|
| Engine Speed (RPM) | 1924 |
| Desired Idle (RPM) | 550 |
| Desired IAC Position | 196 |
| IAC Position | 196 |
| Coolant (°F) | 199 |
| Intake Air (°F) | 116 |
| MAF (g/s) | 70.26 |

Figure 7-7 Bold type on a black background

Selecting opens a menu with two choices: Normal Font and Bold Font. Select a menu item or scroll and then press the **Y/✓** button to make a selection. The change is instantaneous. Select the Back or Home icon on the toolbar to return to either the Settings menu or the Home screen.

Backlight Time

This option allows you to configure how long the screen backlight remains on when the Diagnostic Tool is inactive. The following choices are available:

- Always On
- 15 Seconds
- 30 Seconds
- 45 Seconds
- 60 Seconds

Select the menu item desired, or scroll and then press the **Y/✓** button to make a selection. Select **Back** or **Home** on the toolbar to return to either the Settings menu or the Home screen.

Touch Screen Calibration

Calibrating the touch screen maintains the accuracy of the touch-sensitive display.

IMPORTANT:

To avoid serious damage to the Diagnostic Tool, always complete the touch screen calibration sequence once it has begun. **Never turn off the Diagnostic Tool while a screen calibration is in process.**

**To calibrate the touch screen:**

1. Select **Tools** from the Home screen to open the menu.
2. Select **Settings** from the menu.
3. Select **Touch Calibration** from the menu.
The calibration screen opens ([Figure 7-8](#)).

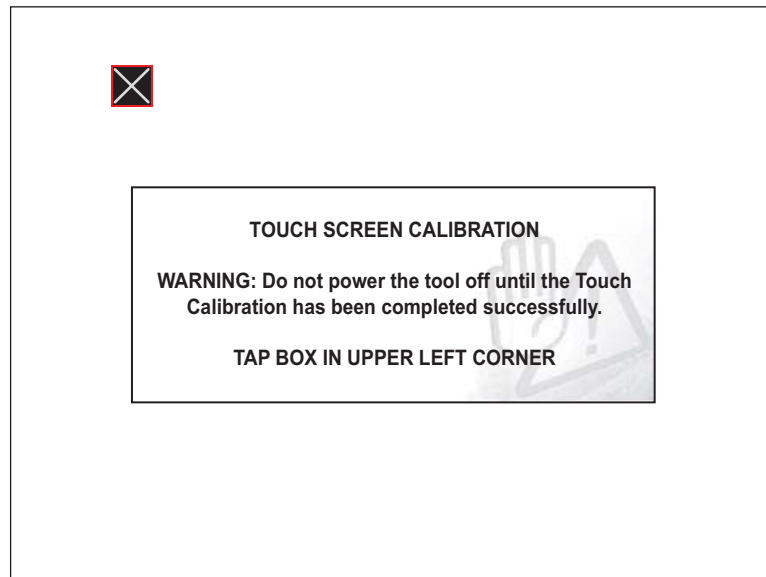

Figure 7-8 *Touch screen calibration*

4. Select each box on the screen as it displays.
The display returns to the Settings menu once the screen calibration procedure is complete.

Time Zone

This option opens a menu of time zone settings. Scroll to highlight, then select the local time zone. The display returns to the Settings menu once a time zone is selected.

IMPORTANT:

A notice that saved files may be overwritten momentarily displays whenever an option that alters the internal clock setting is selected (Figure 7-9). Be sure to transfer any critical files to a PC before continuing with the selected option.

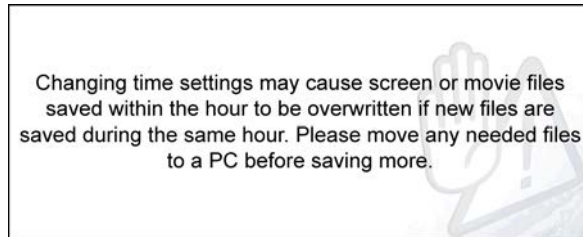

Figure 7-9 Sample possible data loss message

Clock Settings

This option opens a window for resetting the time on the real-time clock.



To set the clock:

1. Select **Tools** from the Home screen to open the menu.
2. Select **Settings** from the menu.
3. Select **Clock Settings** from the menu.

A warning message briefly displays followed by the Clock Settings screen (Figure 7-10).

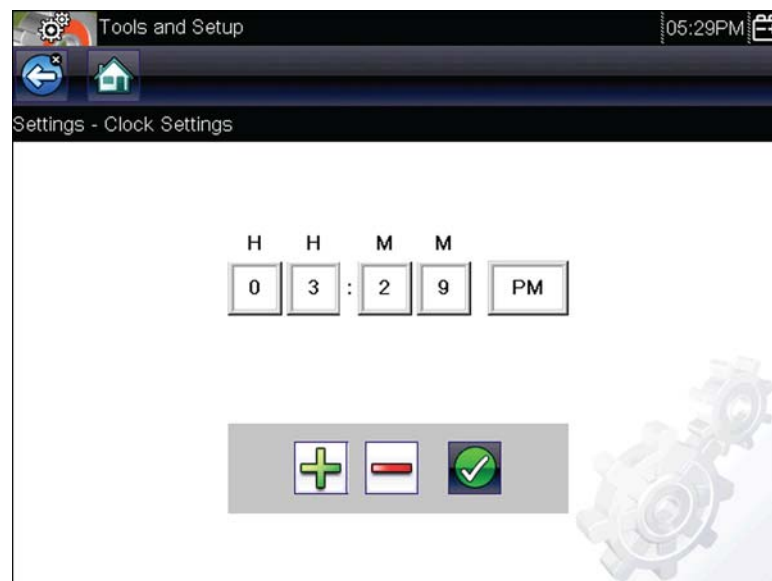

Figure 7-10 Clock settings

4. Select the **up (+)** icon on the screen or press the **up (▲)** button to incrementally increase the number in the highlighted field. Select the **down (-)** icon on the screen or press the **down (▼)** button to incrementally decrease the number.
5. Select the **check (✓)** icon on the screen or press the **Y/✓** button to move the highlight to the next field.
6. Repeat Step 4 and Step 5 until the correct time is displayed.
7. Select the **Back** icon on the toolbar or press the **N/X** button to close the Clock Settings window and return to the Settings menu.

Daylight Savings Time

This option opens a menu to configure the internal clock for Daylight Savings Time. Choose from:

- **ON**—sets the clock for Daylight Savings time.
- **OFF**—sets the clock for standard time.

Make either selection, then select the **Back** icon or press the **N/X** button to return to the menu.

Time Format

This option determines whether time is displayed on a 12 or 24 hour clock. Selecting opens a menu with two choices:

- **24 Hour Format**
- **12 Hour Format**

Make either selection, then select the **Back** icon or press the **N/X** button to return to the menu.

Date Format

This option allows you to select how date information is displayed. Select from:

- **(MM_DD_YYYY)**—Month, Day, Year
- **(DD_MM_YYYY)**—Day, Month, Year
- **(YYYY_MM_DD)**—Year, Month, Day

Make a selection, then select the **Back** icon or press the **N/X** button to return to the menu.

Configuring Scanner

This option allows you to change the scanner display to toggle scales on and off. Scales are the graduations and values that display on the horizontal axis at the base of the parameter graphs. The waveform fills the entire graph area with scales switched off.

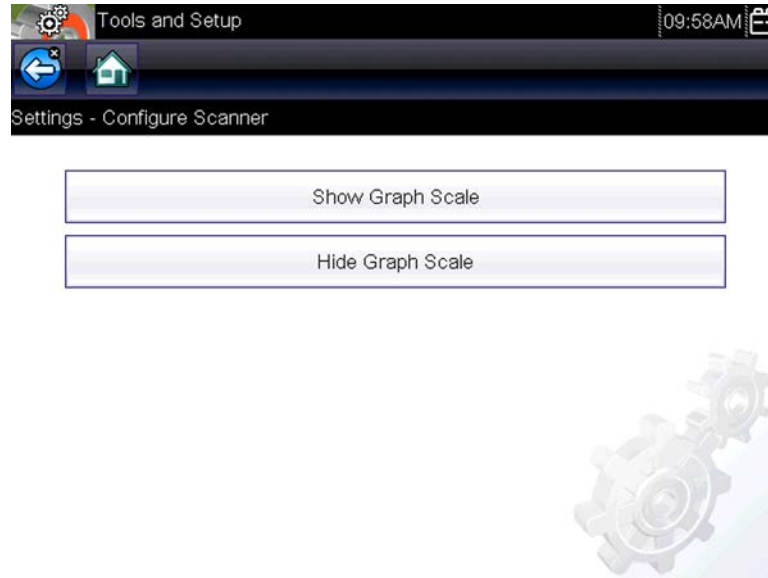

Figure 7-11 Scales hidden



To change hide/show scales:

1. Select **Tools** from the Home screen.
2. Select **Settings** from the Tools and Setup menu.
3. Select **Configure Scanner** from the Settings menu.
4. Highlight either menu entry to make a selection:
 - **Show Graph Scale**—to switch the scales on.
 - **Hide Graph Scale**—to switch the scales off.
5. Select the **Back** icon or press the **N/X** button to return to the Settings menu.

Configure Units

Selecting opens a dialog box that allows you to choose between US customary or metric units of measure for temperature, vehicle speed, air pressure, and other pressures.



Figure 7-12 Configure units menu



To change the units setup:

1. Select **Tools** from the Home screen to open the menu.
2. Select **Configure Units** to open the menu.
3. Select an item from the Configure Units menu.
4. Select a setting from the listed choices.
5. Select **Back** on the toolbar or press the **N/X** button to return to the options menu.

8.1 Cleaning and Inspecting

When using the Diagnostic Tool perform the following tasks to keep it in top shape:

- Check the housing, wiring, and connectors for dirt and damage before and after each use.
- At the end of each work day, wipe the Diagnostic Tool housing, wiring, and connectors clean with a damp cloth.

IMPORTANT:

Do not use any abrasive cleansers or automotive chemicals on the unit.

8.1.1 Cleaning the Touch Screen

The touch screen can be cleaned with a soft cloth and a mild window cleaner.

IMPORTANT:

Do not use any abrasive cleansers or automotive chemicals on the touch screen.

8.2 Battery Service

Follow all safety guidelines when handling the batteries.

 WARNING

Risk of electric shock.

- **Prior to recycling the batteries, protect exposed terminals with insulating tape to prevent shorting.**
- **Disconnect all test leads and turn diagnostic tools off before removing the batteries.**
- **Do not attempt to disassemble the batteries or remove any component projecting from or protecting the battery terminals.**
- **Do not expose the unit or batteries to rain, snow, or wet conditions.**
- **Do not short circuit the battery terminals.**

Electric shock can cause injury.

8.2.1 Battery Safety Guidelines

Keep the following in mind when handling batteries:

- Do not short circuit battery terminals.
- Do not immerse the Diagnostic Tool or batteries in water, or allow water to enter the unit or battery compartment.
- Do not crush, disassemble, or tamper with the batteries.
- Do not heat the batteries to over 100°C (212°F), or dispose of them in a fire.

- Do not expose the batteries to excessive physical shock or vibration.
- Keep batteries pack out of reach of children.
- Do not use a battery that appears to have suffered abuse or damage.
- Store batteries in a cool, dry, well ventilated area.

To prolong the life of your batteries, power off the unit when not in use.

8.2.2 Replacing the Batteries

When replacing the Diagnostic Tool batteries, use Alkaline or rechargeable nickel-metal hydride (NiMH) type AA batteries only. Do not use standard (lead/zinc) batteries as they do not provide sufficient power to operate the Diagnostic Tool, and may leak and damage the Diagnostic Tool.



To replace the batteries:

1. Depress the two battery cover lock tabs and lift off the battery cover.

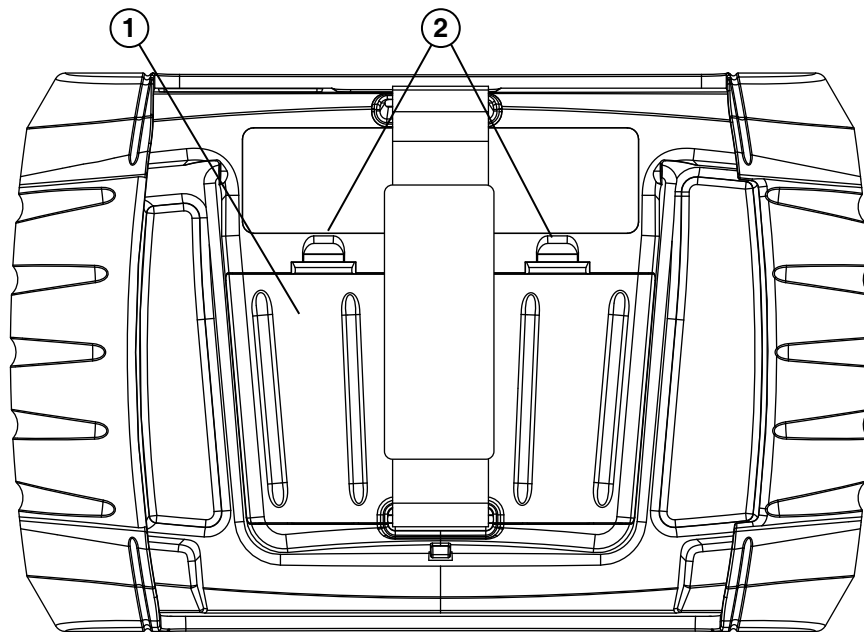

1— Battery Cover

2— Lock Tabs

Figure 8-1 Battery replacement

2. Remove the old batteries.

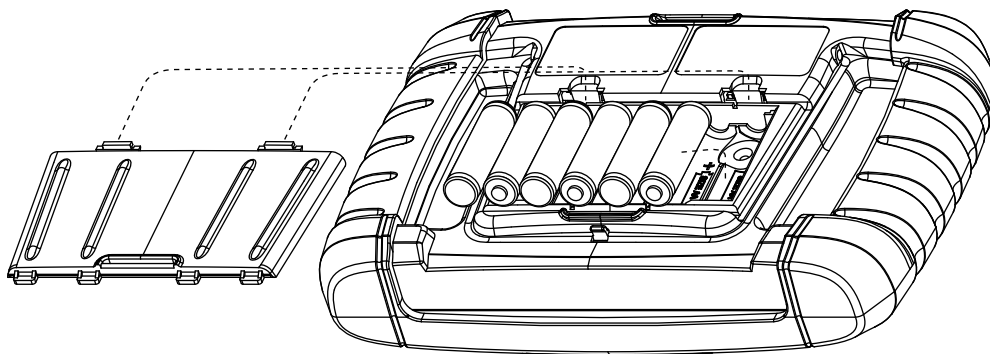

Figure 8-2 Battery cover removed

3. Observing proper polarity (shown on the battery slots), install six new AA batteries.

IMPORTANT:

Your Diagnostic Tool can be damaged if the battery polarity is incorrect. Refer to the diagram in the battery compartment on the rear of the tool for correct battery polarity.

4. Fit the battery cover onto the housing.



NOTE:

If installing rechargeable batteries, be sure to reset the battery type on the Tools Setup menu. This helps prolong the life of the batteries, and notifies you when it is time to recharge them.

8.2.3 Disposing of the Batteries

Always dispose of batteries according to local regulations, which vary for different countries and regions. For additional information contact:

- United States; Rechargeable Battery Recycling Corporation (RBRC) at <http://www.rbrc.org> or <http://www.call2recycle.org>, or call 1(800) 822-8837

Products bearing the WEEE logo (Figure 8-3) are subject to European Union regulations.



Figure 8-3 sample WEEE logo



NOTE:

Always dispose of materials according to local regulations.

Contact your sales representative for details.

This chapter includes a brief introduction to some of the key features of the ShopStream Connect software. For detailed ShopStream Connect information and instructions, download the ShopStream Connect User Manual from our website: <http://diagnostics.snapon.com/usermanuals>

The ShopStream Connect™ (SSC) software is PC-based software that extends the capabilities of your diagnostic tool. Using ShopStream Connect software with your diagnostic tool allows you to do the following:

- View, Print, and Manage data saved from your Diagnostic tool.
- Move and copy your data between the diagnostic tool and your PC.
- View and Print trouble codes saved with select diagnostic tools. This allows you to share the data in a report format with vehicle owners or other technicians.
- Add or edit notes and comments to diagnostic tool data files.
- Download and install diagnostic tool software updates and upgrades.

The ShopStream Connect (SSC) software is available (free of charge) at:

ShopStream Connect - <http://diagnostics.snapon.com/ssc>

9.1 Using SSC (Connecting to your PC)



To connect and use SSC with your diagnostic tool:

1. Download and install SSC on your PC from: <http://diagnostics.snapon.com/ssc>
2. Turn your diagnostic tool on.
3. Connect the supplied USB cable from the USB jack on your diagnostic tool to your PC:
4. From the diagnostic tool Home screen, select **Tools > Connect-to-PC**.

The “**Device is now in Connect-to-PC mode**” screen message is displayed (Figure 9-1) and the ShopStream Connect software will open automatically on your PC (Figure 9-2).

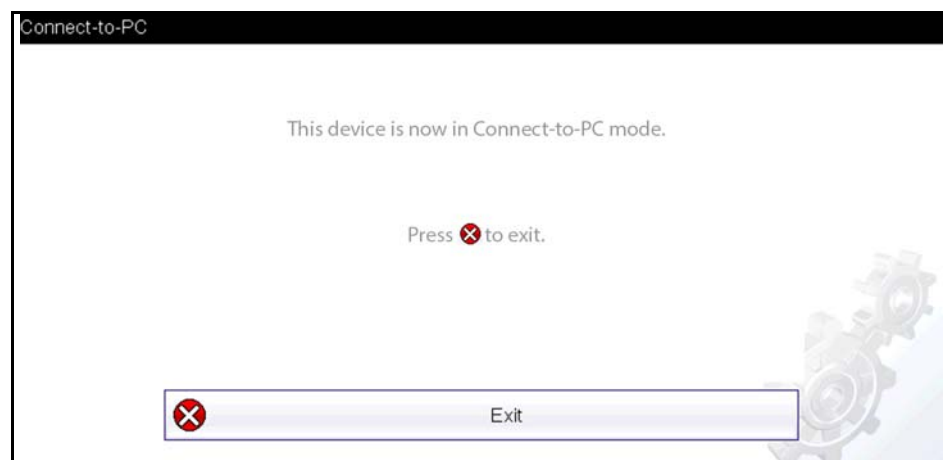

Figure 9-1

If the ShopStream Connect software does not open, open it from the Windows Start menu or use the ShopStream Connect shortcut icon on the Windows desktop (automatically created during installation).

9.2 SSC Main Screen

The ShopStream Connect software will open automatically when you connect the diagnostic tool to your PC USB connection, [Using SSC \(Connecting to your PC\)](#), on page 70,.

The following shows the main screen layout for ShopStream Connect software.

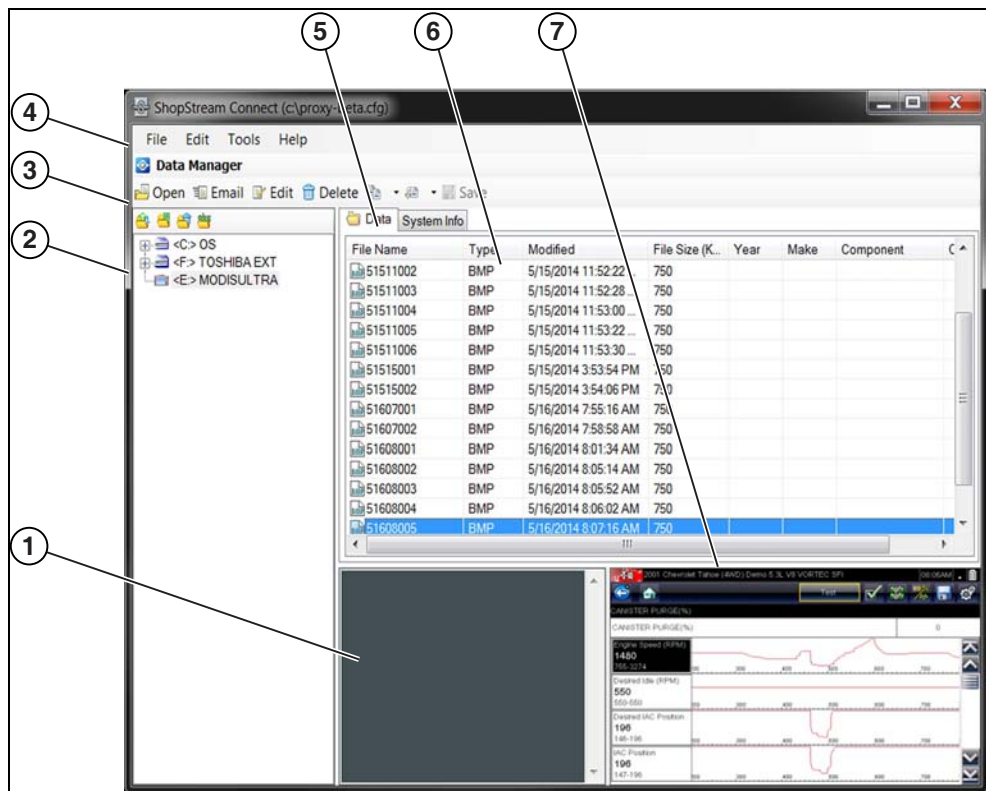

Figure 9-2

- 1— **Notes Window**—allows you add notes to select data files. Select Save from the menu bar to save your notes. *NOTE: Not all file types allow notes, the Notes window will be grayed out when a file type that does not support notes is highlighted. Some image files may display notes for reference purposes (the notes are grayed out and not editable).*
- 2— **File directory structure**—displays the file directory structure of your PC in standard Windows format, and shows any connected diagnostic tools at the bottom of the data list.
- 3— **Data Manager Toolbar**—provides control icons that perform a variety of operations on data files.
- 4— **Main Menu bar**—contains **File**, **Edit**, **Tools**, and **Help** menus.
- 5— **Tabs**—provides access to data files and presets stored on the diagnostic tool or on the PC, and also allows viewing of software revision details of the diagnostic tool.

- 6— **Main display**—shows stored data files details. *NOTE: The files listed are sortable (ascending/descending) by clicking on the column tab at the top (e.g. File Name, Type, etc.) Sort preferences are saved when the ShopStream Connect program is closed.*
- 7— **Preview**—displays a sample of the file if the selected file is a image file.

9.3 Scanner DataViewer

SSC allows you to view data files recorded with your diagnostic tool, on your PC. When a Scanner data file is selected, it opens and displays in the Scanner DataViewer (Figure 9-3). Scanner DataViewer allows you play the data file and custom configure the data in a number of ways.



- 1— Menu bar
- 2— Display toolbar
- 3— Graph display
- 4— Properties icon
- 5— Vertical Scroll bar
- 6— Zoom controls
- 7— Slider bar
- 8— Navigation toolbar
- 9— Parameter text list
- 10— Highlighted PIDs - indicates graphs currently displayed
- 11— Parameter configuration tabs

Figure 9-3

9.4 Image Viewer

SSC allows you to view and print .bmp, .jpg and .sps image files (screenshots) saved on your diagnostic tool, with your PC.

**NOTE:**

File extension types vary depending on the diagnostic tool. Not all the file extensions described here may be available on your diagnostic tool.



1— Exit - closes the Image Viewer
2— Print - prints the image

3— Print Preview - allows the image to be previewed before printing
4— Captured Screen Image

Figure 9-4

9.5 Printing the Code Scan Report

To print the Code Scan Report, the saved code scan .XML file must be opened using ShopStream Connect.

To print the Code Scan Report using ShopStream Connect:

1. Double-click the code scan .XML file from the file list to open the report (Figure 9-5) in the Code Scan Viewer (Figure 9-6).

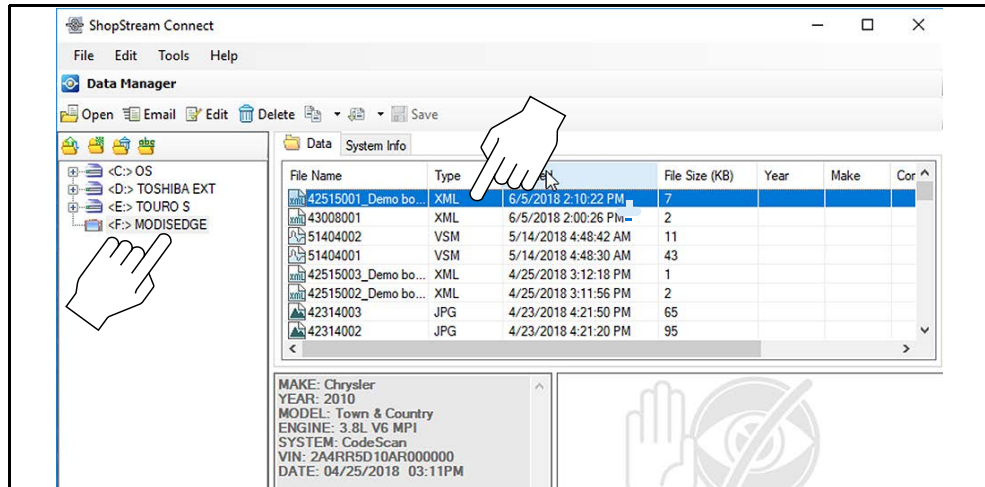

Figure 9-5

2. Select **Print** or **Print Preview** from the Code Scan Viewer menu to print or preview the report (Figure 9-6).

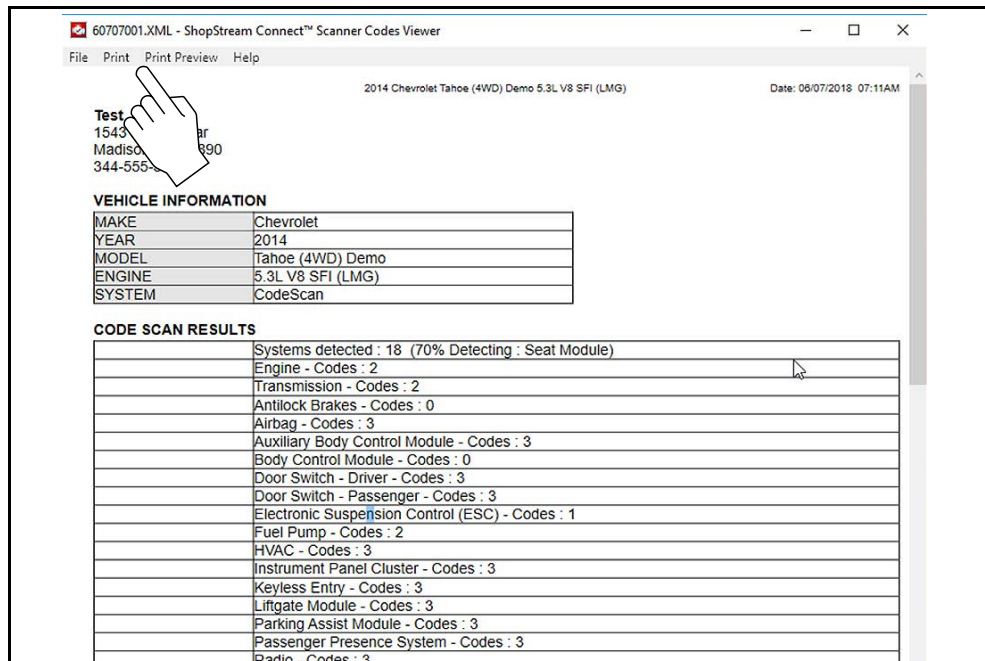

Figure 9-6

Selecting **Print** opens the Windows print dialog window (Figure 9-7). Select your printer from the list, then select **Print** to print the report.

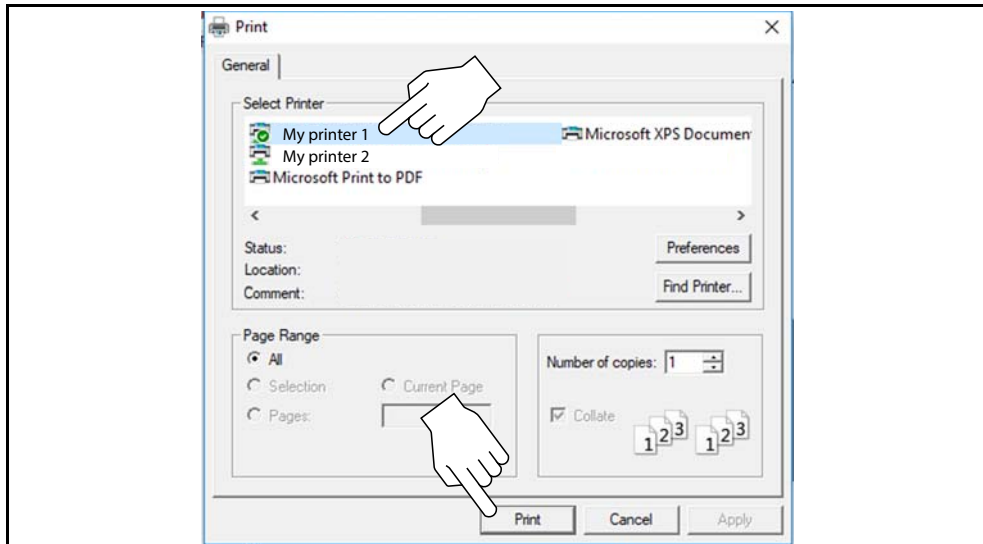

Figure 9-7

9.6 Software Upgrades and Updates

Upgrade/Update Descriptions:

- **Software Upgrade** - a software upgrade is a new software version (contact your sales representative for purchase information).
- **Software Update** - a software update is a service release for installed software. These are available free of charge, and are provided as necessary to update installed software. When your diagnostic tool is connected to a PC using SSC, the SSC software will automatically check for updates, and if an update is available, it will provide installation instructions. Follow the screen prompts to accept, download and install the software.



NOTE:

To receive updates or upgrades, SSC software must be installed on your PC and have connection to the Internet.



Example - Updating diagnostic tool software:

1. Select **Tools > Update Software > (diagnostic tool type - e.g. ETHOS Edge, MODIS Edge, SOLUS Edge, etc.)** from the Menu bar (Figure 9-8).
The software checks the Snap-on web server for available updates.

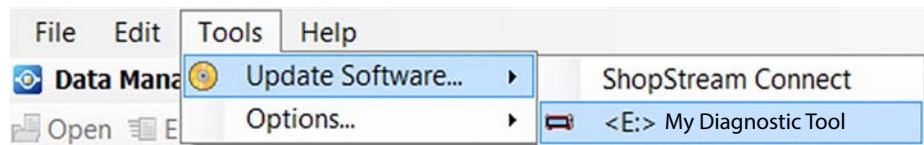

Figure 9-8

2. If service release updates are available, select **Next** to continue, then select **Download** and follow the on-screen instructions to complete the installation (Figure 9-9).

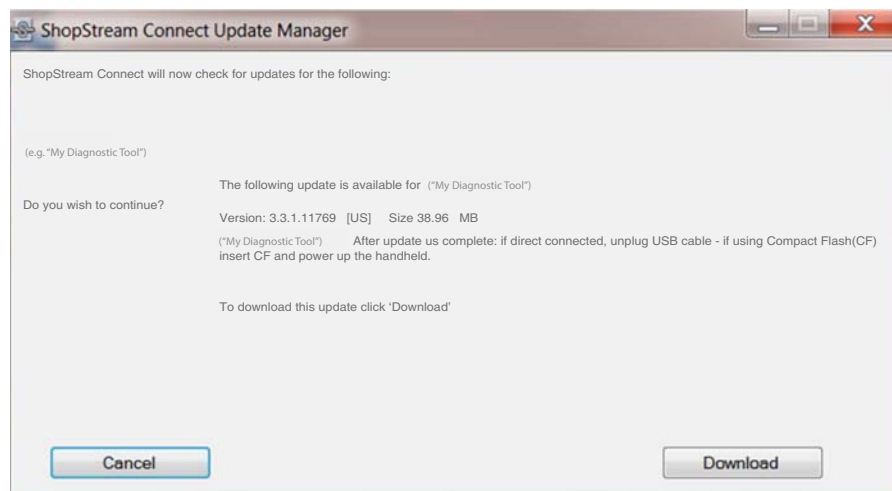

Figure 9-9



NOTE:

For additional information on ShopStream Connect software updates and upgrades, download the ShopStream Connect User Manual from our website: <http://diagnostics.snapon.com/usermanuals>

9.6.1 End User License Agreement

Before software installation at initial purchase, and before all subsequent software updates/ upgrades installations End User License Agreement (EULA) acceptance is required.

IMPORTANT:

Use of Software is governed by the terms and conditions of the End User License Agreement. The diagnostic tool should not be initially operated until the End User License Agreement is read. Use of the device acknowledges your acceptance of the End User License Agreement. The Snap-on Incorporated Software End User License Agreement is available at: <https://eula.snapon.com/diagnostics>

To Accept: at the screen prompt (Figure 9-10) click the checkbox on the left side of the window, and then select **Agree and Continue**. The software will be installed automatically.

Figure 9-10 below represents a typical EULA acceptance agreement screen.

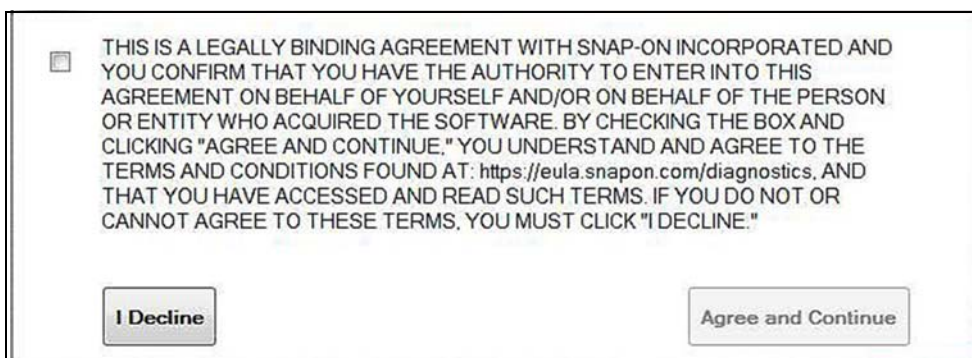

Figure 9-10 Typical EULA acceptance screen

To Decline: at the screen prompt (Figure 9-10) select **I Decline**. A confirmation message is displayed providing options to Go Back or Exit the software installation (Figure 9-11).

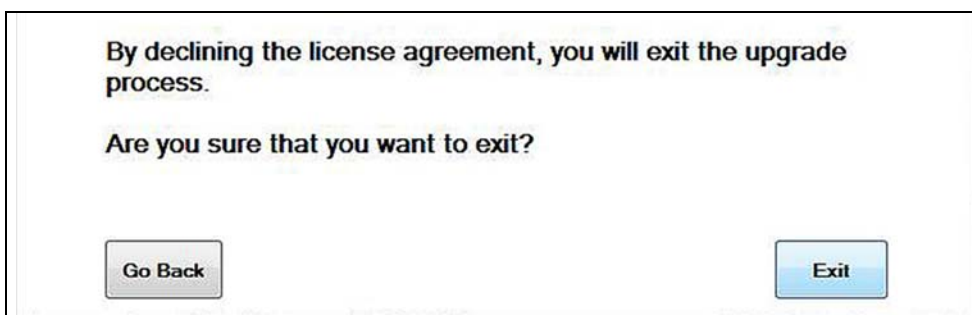

Figure 9-11 Typical EULA acceptance screen

10.1 SureTrack - Online Community

Your diagnostic tool includes access to the online SureTrack Community. You can use your PC to access the latest Real Fixes, Related Tips, and Common Repair Procedures information.

SureTrack is an evolving database of "real-world" automotive repair knowledge based on expert knowledge and millions of actual repair orders. It was designed to help you improve diagnostic accuracy and reduce repair times.

10.1.1 Main Topic Links

- [Finding your SureTrack Authorization Code](#) page 79
- [Creating a SureTrack Account](#) page 80
- [Logging In \(active account\)](#) page 84
- [Logging In with New Authorization Code \(active account\)](#) page 85
- [SureTrack Features](#) page 88
- [SureTrack Screens](#) page 89

10.1.2 Quick Reference

SureTrack Community FAQ's

For the latest SureTrack Community information and answers to frequently asked questions visit: mitchell1.com/support/suretrack-faqs/

Using SureTrack for the First Time

If you have purchased a new diagnostic tool, you will need to create a SureTrack account before you can access SureTrack. See [Creating a SureTrack Account](#), on page 80 for instructions.

Login Scenarios

- I already have an active SureTrack account with username and password - [Logging In \(active account\)](#), on page 84.
- SureTrack has already expired, but I purchased a qualifying upgrade/plan and have a new SureTrack authorization code (reactivation) - [Logging In with New Authorization Code \(expired account\)](#), on page 86.
- SureTrack is still active, but I have purchased a qualifying upgrade/plan and have a new SureTrack authorization code (reactivation) - [Logging In with New Authorization Code \(active account\)](#), on page 85.

10.1.3 Finding your SureTrack Authorization Code

When you purchase a qualifying upgrade/plan, or platform from your Snap-on Representative, you will receive a SureTrack authorization code. The authorization code is printed on your sales receipt. Authorization codes are 12 digit alpha-numeric codes (e.g. 123ABCAP4-US).

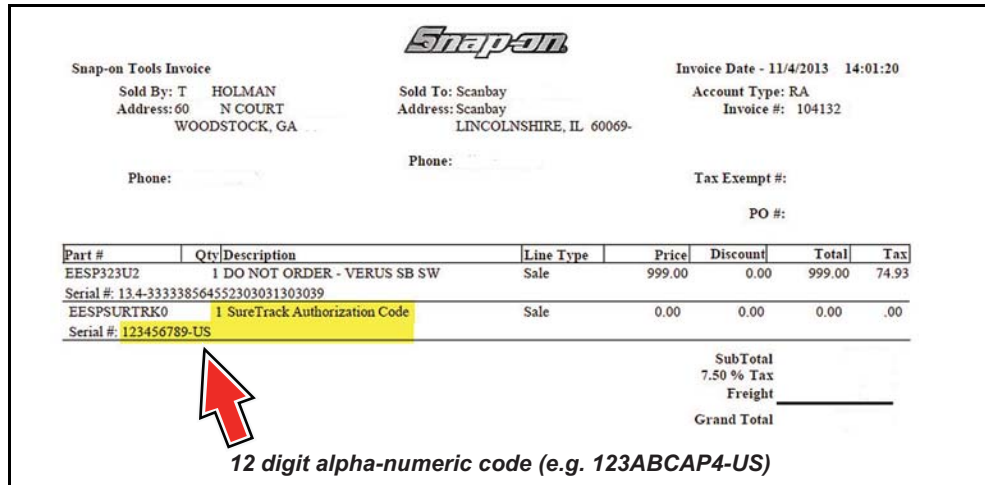

Figure 10-1

After obtaining a new upgrade/plan you will receive a new SureTrack authorization code.

Each time you purchase a qualifying diagnostics upgrade/plan you will be provided a new SureTrack authorization code. The authorization code will expire as noted in the upgrade/plan details. To log in with a new authorization code, see [Logging In with New Authorization Code \(expired account\)](#), on page 86.

10.1.4 Creating a SureTrack Account

Use Requirements

To use SureTrack you must:

- Create a SureTrack Account, see [Creating an Account](#), on page 80.
- Have a current SureTrack Authorization Code, see [Finding your SureTrack Authorization Code](#), on page 79.
- Have access to a PC with an Internet connection.

Creating an Account

If you are a new member (do not have an existing SureTrack account), you will need to complete the online registration before you can use SureTrack. Use the following procedure to create an account.

1. On your PC visit: <https://shopkeypro.com>
2. To create an account use the following illustrated instructions. Step numbers are provided in each illustration, follow the sequence to completion.

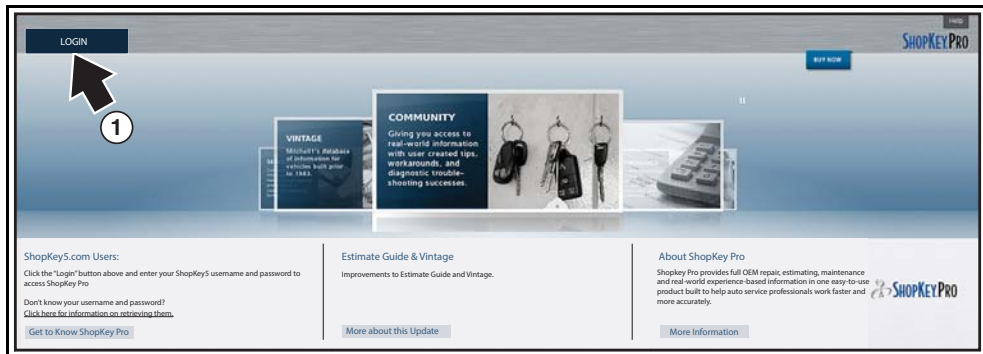

Figure 10-2

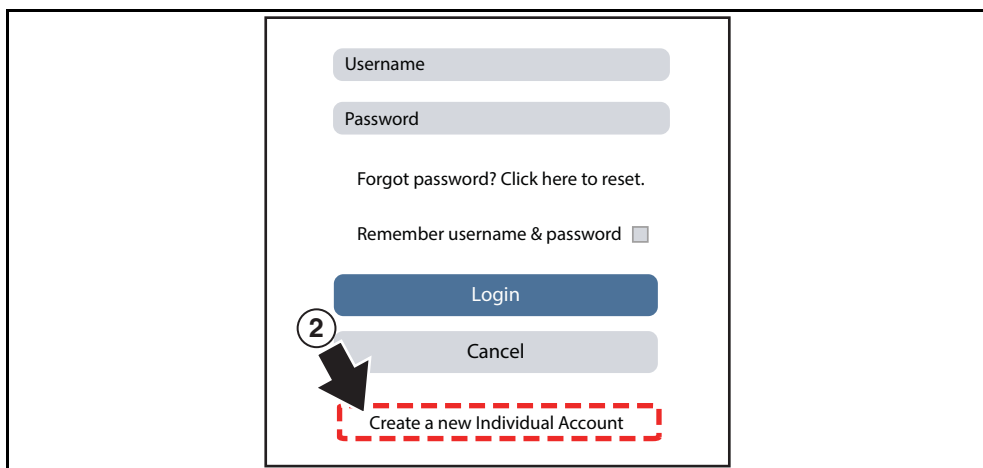

Figure 10-3

Email

3 Enter all required* information.

Email Address*

Name Phone

First Name* Last Name* Phone Number

Address

Address Line 1

Address Line 2

City* State* Zipcode

Online Profile

Username*

Password* Retype Password*

Cancel Create

4

Figure 10-4

Success X

Congratulations! Your account has been created.

This account can be used to contribute to the community and manage your profile.

To link this account to your shop, have your shop add you in Profile Manager.

5 Done

Figure 10-5

Username Password **6**

Forgot password? Click here to reset. **7**

Remember username & password **7**

Login

8 Cancel

Create a new Individual Account

Figure 10-6

9 Choose 3 security questions.

Select three questions below. These questions will help us verify your identity should you forget your password.

Question 1: Choose a question...

Question 2: Choose a question...

Question 3: Choose a question...

Cancel Submit

10

Figure 10-7

Snap-on

Snap-on Tools Invoice Invoice Date - 11/4/2013 14:01:20

Sold By: T HOLMAN Sold To: Scanbay Account Type: RA
 Address: 60 N COURT Address: Scanbay Invoice #: 104132
 WOODSTOCK, GA LINCOLNSHIRE, IL 60069

Phone: Phone: Tax Exempt #: PO #:

| Part # | Qty | Description | Line Type | Price | Discount | Total | Tax |
|---------------------------------------|-----|------------------------------|-----------|--------|----------|--------|-------|
| EESP323U2 | 1 | DO NOT ORDER - VERUS SB SW | Sale | 999.00 | 0.00 | 999.00 | 74.93 |
| Serial # 134-333338564552303031303039 | | | | | | | |
| EESPSURTRKO | 1 | SureTrack Authorization Code | Sale | 0.00 | 0.00 | 0.00 | .00 |
| Serial # 123456789-US | | | | | | | |

Sub Total
 7.50 % Tax
 Freight
 Grand Total

11 Find the SureTrack Authorization Code on your sales receipt.
 12 digit alpha-numeric code (e.g. 123ABCAP4-US)

Figure 10-8

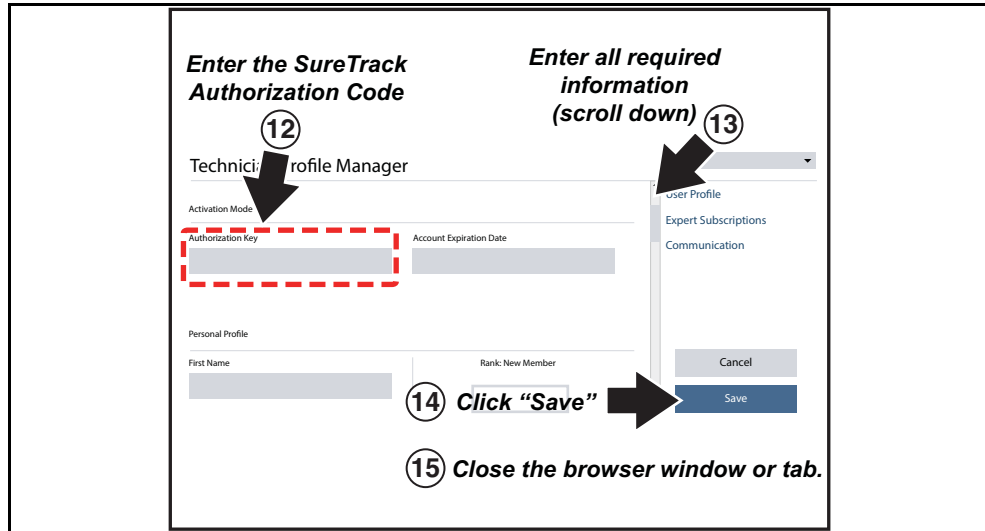

Figure 10-9

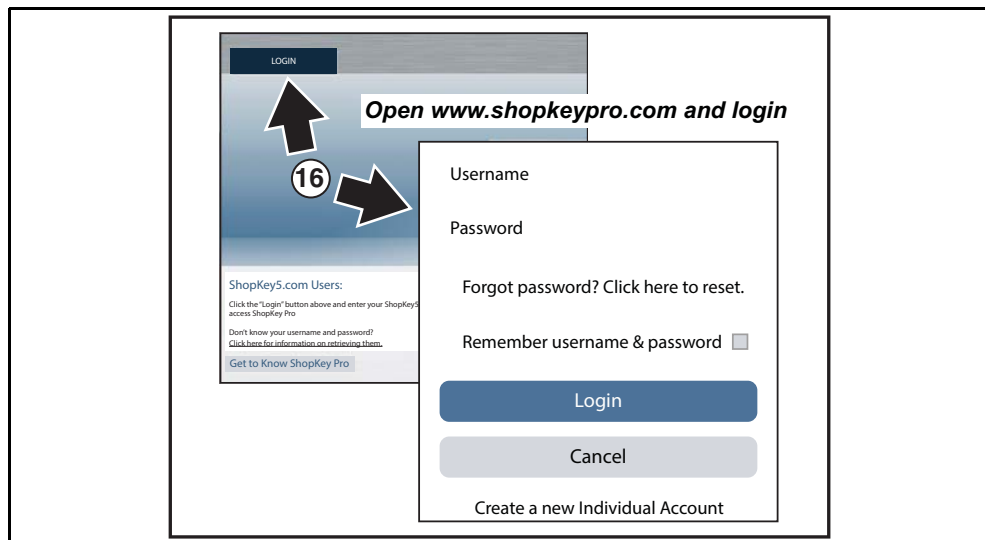

Figure 10-10

10.1.5 Logging In (active account)

If you have previously created a SureTrack account, and have a valid username and password, select **LOGIN** (Figure 10-11) from the ShopKey Pro start page, and then complete the login process (Figure 10-12). Once successfully logged in you will be directed to the 1Search *Limited* results page. See [SureTrack Screens](#), on page 89.

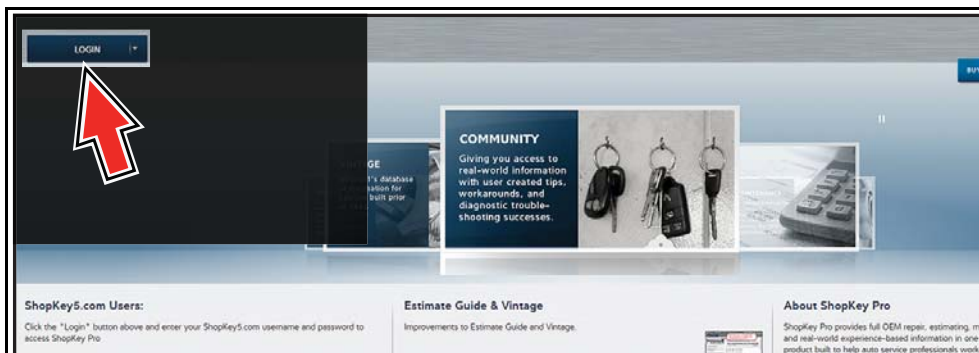

Figure 10-11

If you have previously selected the "remember me" checkbox in the login screen you will skip the login and be automatically directed to the 1Search Limited results page.

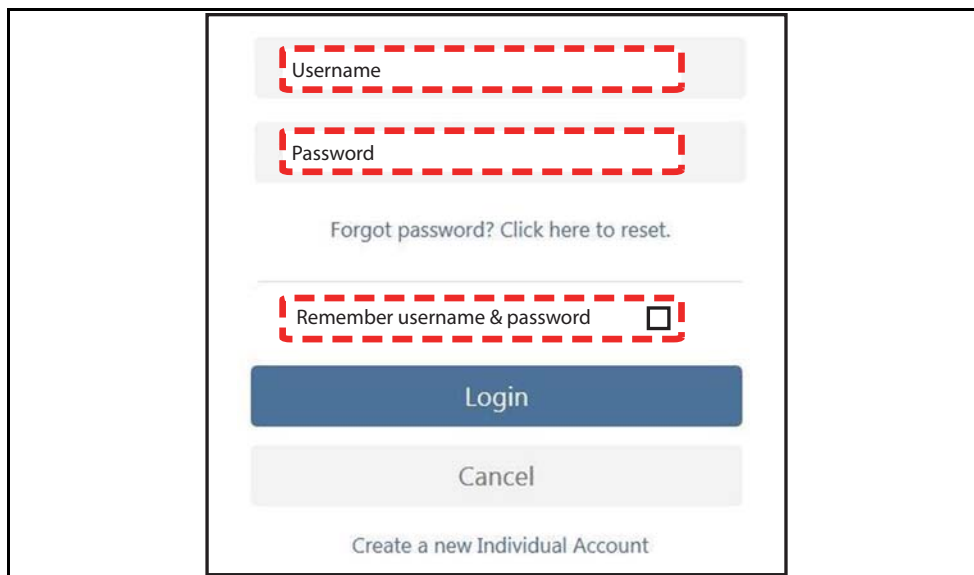

Figure 10-12

10.1.6 Logging In with New Authorization Code (active account)

Use the following instructions, if you have purchased a qualifying upgrade/plan and your SureTrack account is active (has not expired). To find your new authorization code, see [Finding your SureTrack Authorization Code](#), on page 79.

1. Log in to ShopKeyPro.com using your current username and password.
2. At the ShopKey Pro start page, select your username (Figure 10-13), then select **Profile Manager** from the dropdown menu.

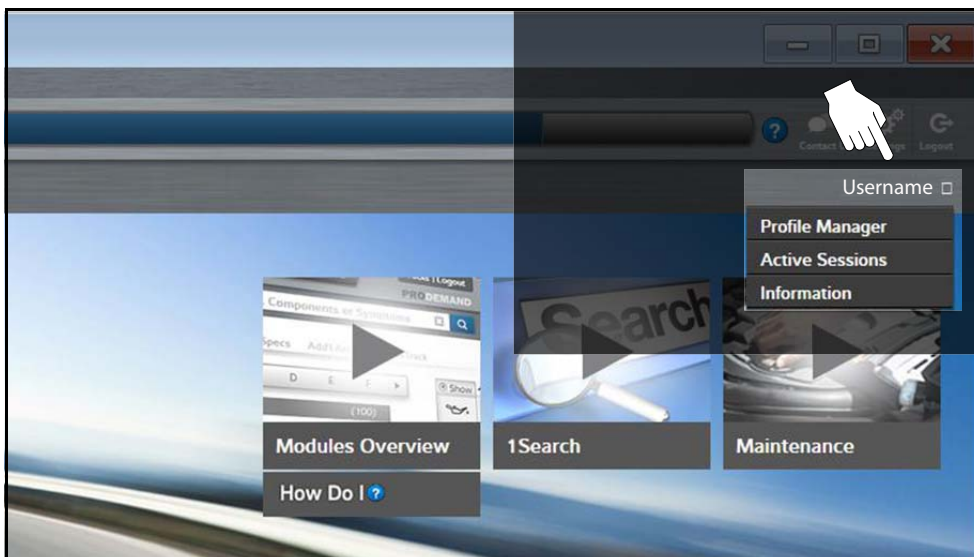

Figure 10-13

3. Log in to the Profile Manger (Figure 10-14) using your current username and password.
4. Enter your new **Authorization code** (Figure 10-14).

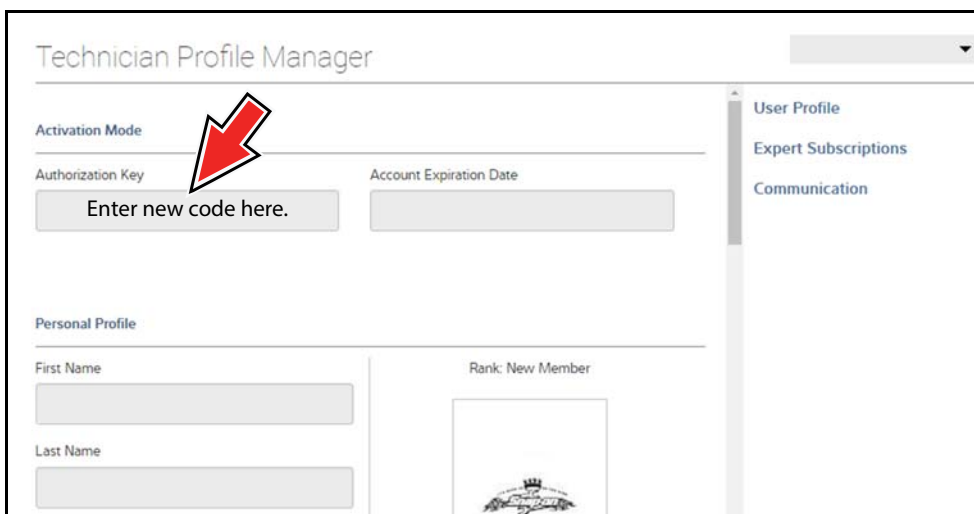

Figure 10-14

5. Review and update the rest of your profile and make sure all required fields are filled out.
6. Select **Save**.

7. Exit the Profile Manager by selecting your username (near the top right) and select **Logout**.
8. When the login screen displays, login using your current username and password.
9. Confirm the new expiration date by logging back into Profile Manger to check it.

10.1.7 Logging In with New Authorization Code (expired account)

Use the following instructions, if your SureTrack account has expired, and you have purchased a qualifying upgrade/plan. Your new upgrade/plan comes with a new SureTrack authorization code. To find your new authorization code, see [Finding your SureTrack Authorization Code](#), on page 79.

1. Log in to ShopKeyPro.com using your using your current username and password.

When your SureTrack account has expired, and you try to login you are directed to an information window ([Figure 10-15](#)).

2. Scroll down and select the link shown in ([Figure 10-15](#))

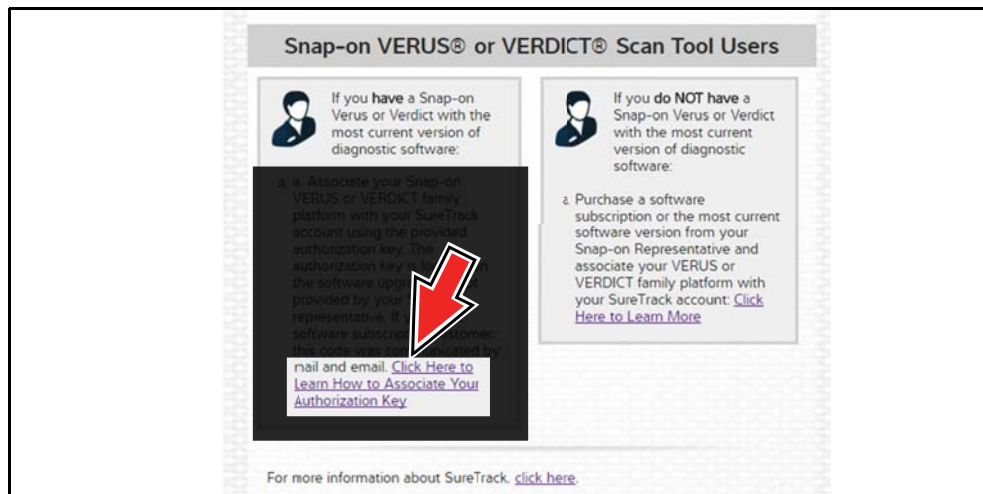

Figure 10-15

3. The SureTrack FAQ webpage opens ([Figure 10-16](#)).

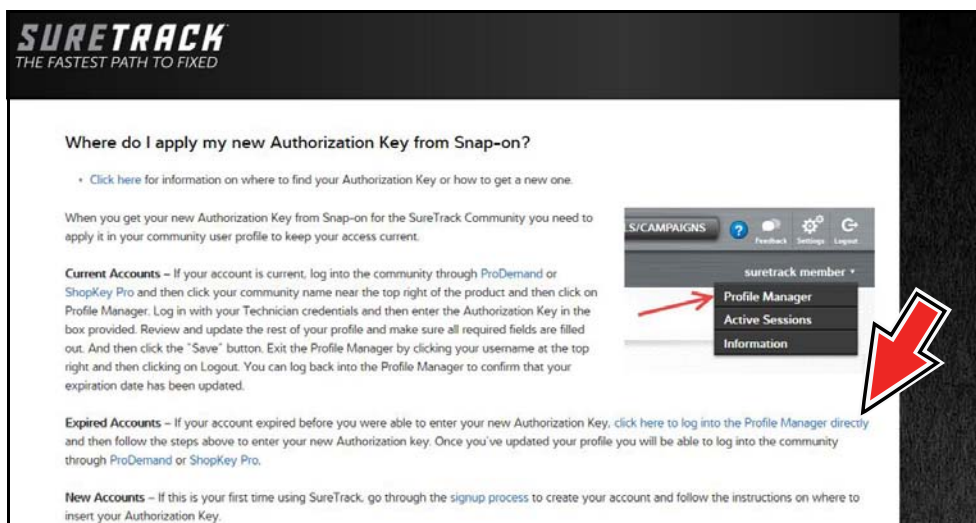

Figure 10-16

4. Scroll to the topic "Where do I apply my new Authorization Key from Snap-on?"
5. Select the link "click here to log into the profile manager login window directly".
 - URL - <https://profilemanager.mitchell1.com/technicianprofile/index>

The SureTrack renewal window opens.

6. Enter your current username and password.

The SureTrack Profile Manager window opens.

7. Enter your new **Authorization code** (Figure 10-17).

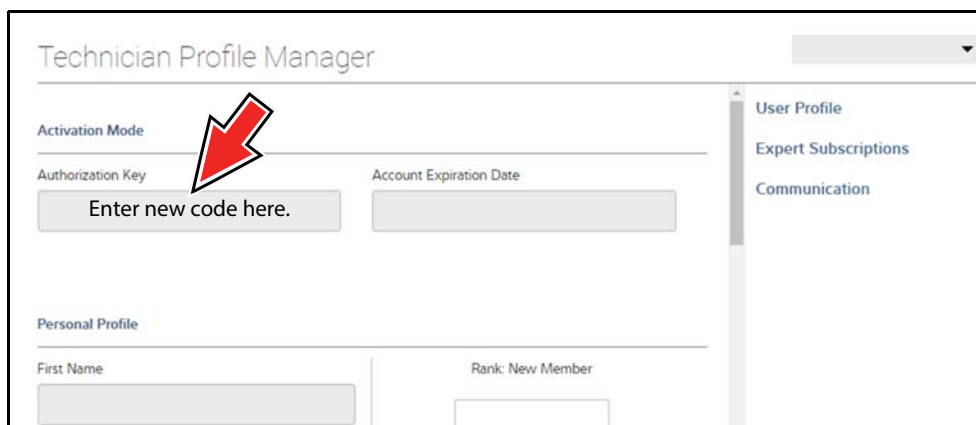

Figure 10-17

8. Review and update the rest of your profile and make sure all required fields are filled out.
9. Select **Save**.
10. Exit the Profile Manager by selecting your username (near the top right) and select **Logout**.
11. When the login screen displays, login using your current username and password.
12. Confirm the new expiration date by logging back into Profile Manger to check it.

10.1.8 SureTrack Features

SureTrack is an integrated part of ShopKey Pro, and includes two navigation modules providing search and forum capabilities:

- 1Search™ *Limited*
- Sure Track Community.

1Search™ *Limited*

The **1Search *Limited*** module includes the following information features:

- **Real Fixes and Tips** - real-world fixes and repair tips captured from actual repair orders and the experiences of professional technicians.
- **Common Repair Procedures Graph** - graphical display of the specific parts and procedures most frequently used to fix the selected code or symptom.
- **ProView** - provides graphical displays showing the direct relationship between a code or symptom to the component used to fix them.
- **Component Tests** - includes instructions on how to test the component, and descriptions of component operation, component locations, test locations, connector end views and even sample waveforms.
- **TSB's** - OEM technical service bulletins.
- **Safety Recalls and Campaigns** - safety recall and service campaign information.

SureTrack Community

The **Sure Track Community** module is a forum-based application that connects you with a community of other professional technicians to find and share information, ask questions, and provide your own tips.

10.1.9 SureTrack Screens

SureTrack Home Page (within ShopKey Pro)

The SureTrack Home page within ShopKey Pro includes:

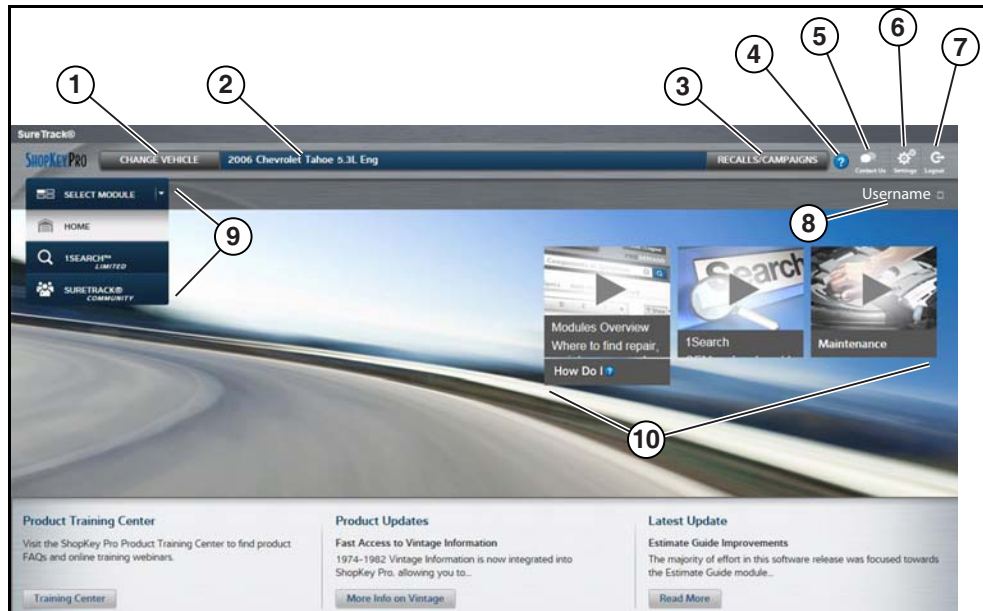

Figure 10-18

1. **Change Vehicle*** - dropdown menu provides options to change the active vehicle
2. **Active Vehicle*** - displays active vehicle
3. **Recall/Campaigns*** - displays available OEM recalls and campaigns
4. **Help*** - provides SureTrack and ShopKey Pro online help topics
5. **Contact Us*** - provides options for contacting ShopKey Pro customer service
6. **Settings*** - provides general setting options and information
7. **Logout*** - logs you off of ShopKey Pro
8. **User ID options menu*** - displays username, selecting opens Profile Manager and other options
9. **Main Menu (dropdown)*** - Options are Home, 1Search *Limited*, and SureTrack Community
10. **General Training and Information Links (various)**

* available on all pages

1Search *Limited* Top 10 Results Page

Selecting **1Search *Limited*** displays a Top 10 results page which includes:

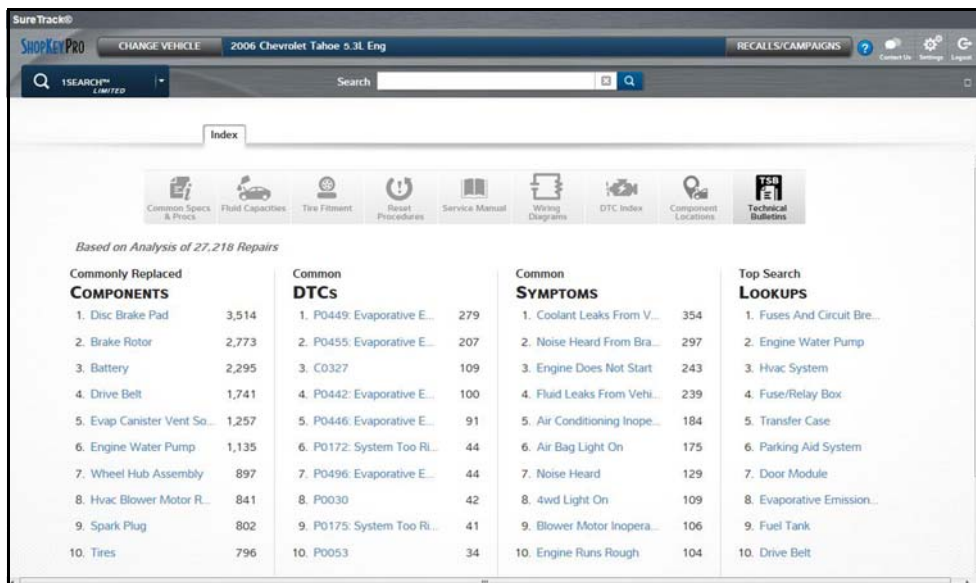

Figure 10-19

- **Search Bar** - use the search bar to enter a code, component or symptom to search. For best results keep search terms short (e.g. water pump, not - water pump replacement).
- **Page Tabs** - use the page tabs to navigate to related information (e.g. Index, SureTrack, ProView, etc) varies per application
- **Quick-links** - Technical Service Bulletins (TSBs) is the only available option
- **Repair Totals indicator** - displays the total number of repairs that all displayed data was based on
- **Top 10 lists** - display the most popular repairs and lookups by existing users for the selected vehicle (select an item from any list to view the Results Index, see [Results Index Page](#), on page 91)
 - Top 10 - Commonly Replaced Components
 - Top 10 - Common DTCs
 - Top 10 - Common Symptoms
 - Top 10 - Top Search Lookups

Results Index Page

The Results Index page includes:

- **OEM Plus Results** - provides results that best match the exact search criteria, ranked in order with the closest match at the top.
- **SureTrack Results** - provides probable components related to the search criteria, ranked in order from the most likely to the least likely component.

Select an item from either list to view the results, see [SureTrack Results Page](#), on page 92).

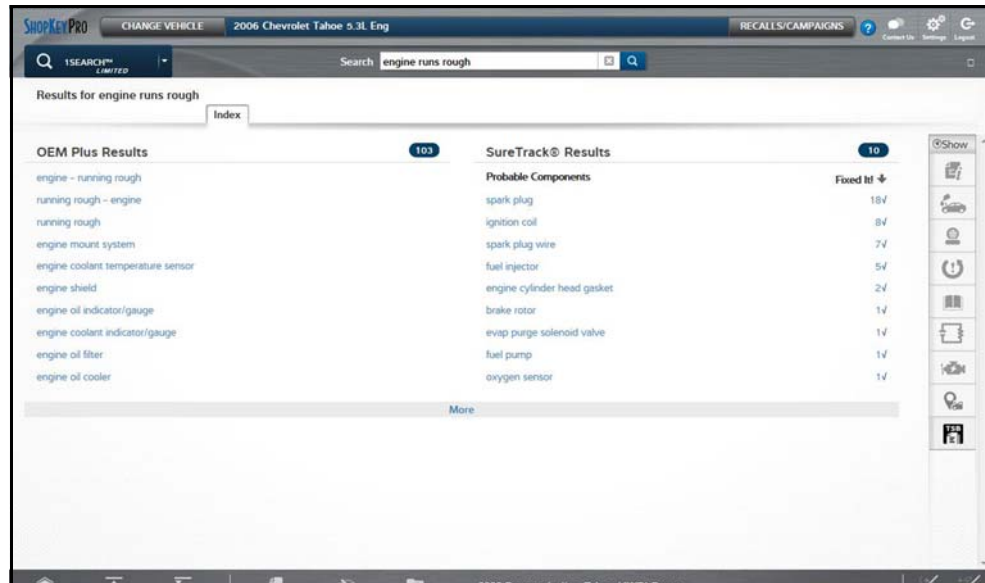

Figure 10-20

SureTrack Results Page

Selecting an item from the Results Index page displays applicable repair information on the SureTrack results page.



Figure 10-21

Information may include:

- **Real Fixes and Tips** - real-world fixes and repair tips captured from actual repair orders and the experiences of professional technicians.
- **Common Repair Procedures Graph** - graphical display of the specific parts and procedures most frequently used to fix the selected code or symptom.
- **Component Tests** - includes instructions on how to test the component, and descriptions of component operation, component locations, test locations, connector end views and even sample waveforms.
- **TSB's** - OEM technical service bulletins.
- **Safety Recalls and Campaigns** - safety recall and service campaign information.

ProView Results Page

Selecting the **ProView** tab from the SureTrack results page opens ProView. ProView provides graphical displays showing the direct relationship between a code or symptom to the component used to fix them.

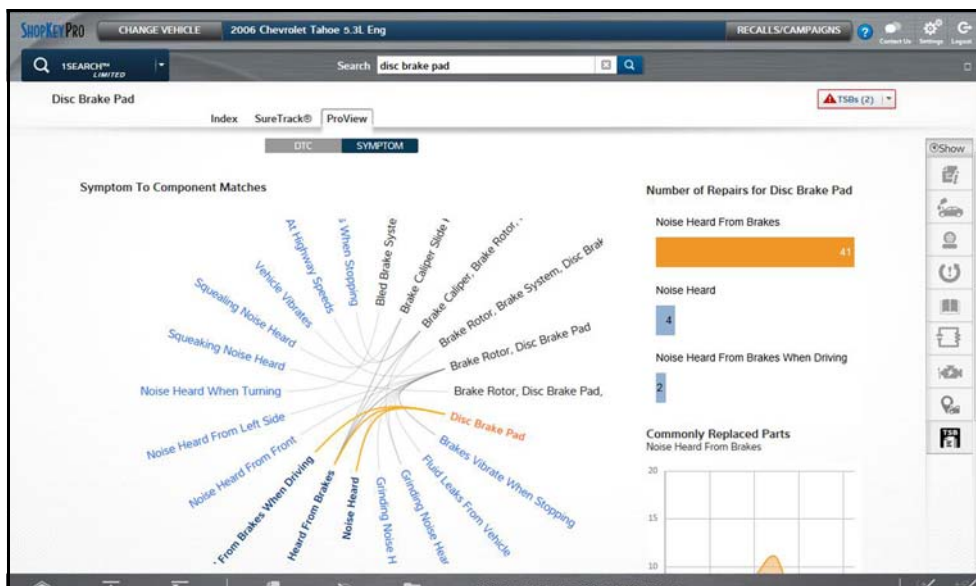

Figure 10-22

Information may include:

- **Radial Graph** - showing the relationship of the code or symptom to possible at fault components.
- **Component Frequency Graphs** - showing the most commonly replaced component for that code or symptom.
- **Common Replaced Parts Graphs** - showing the mileage at which the most common component is replaced.